



ΘΕΟΔΩΡΙΑΔΗΣ ΙΩΑΝΝΗΣ & ΥΙΟΣ Ο.Ε.



Η Εταιρία ΘΕΟΔΩΡΙΔΗΣ ΙΩΑΝΝΗΣ & ΥΙΟΣ ΟΕ εδρεύει στην Θεσσαλονίκη, και δραστηριοποιείται με επιτυχία στον τομέα των βιομηχανικών - ανοξείδωτων ειδών.
Ιδρύθηκε το 1977 από τον ΘΕΟΔΩΡΙΔΗ ΙΩΑΝΝΗ και από τότε με συνεχή ανοδική πορεία, παρέχει υποστήριξη σε επαγγελματίες και ερασιτέχνες στις ανάγκες τους σε βίδες, εργαλεία και συναφή είδη.
Η εταιρία είναι σε θέση να καλύπτει τις ανάγκες των πελατών της σε μεγάλη ποικιλία προϊόντων με αξιοπιστία και εμπιστοσύνη.

Τραπεζικοί λογαριασμοί

Eurobank:

Όψεως: 0026 0216 9502 0041 3792

IBAN: GR66 0260 2160 0009 5020 0413 792

Πειραιώς:

Όψεως: 5223-074887-080

IBAN: GR93 0172 2230 0052 2307 4887 080

Εθνική:

Όψεως: 236/440409-27

IBAN: GR65 0110 2360 0000 2364 4040 927



Στοχεύστε για να δείτε διαδρομή μέσω Google maps



Ρούχα εργασίας

- 17. Παπούτσια
- 19. Αξεσουάρ υπόδυσης
- 20. Παντελόνια
- 22. Μπουφάν
- 24. Φλις - Εσωθερμικά
- 25. Γυαλιά - Μάσκες
- 26. Μάσκες - Ωτασπίδες
- 27. Προστασία πτώσης
- 28. Κράνη - Επιγονατίδες
- 29. Γάντια

Εργαλεία

- 30. Θήκες εργαλείων - Εργαλειοθήκες
- 39. Κολλητήρια - Καλάι
- 42. Φλόγιστρα
- 44. Οξυγονοκολλήσεις
- 45. Ανταλλακτικά οξυγονοκολλήσεων
- 46. Γκαζάκια - Αναπτήρες - Σχοινιά
- 47. Ιμάντες πρόσδεσης - ανύψωσης
- 48. Φακοί - Σετ ξυλογλυπτικής - Σκαρπέλα - Μαχαίρια
- 49. Ακονόπετρες
- 50. Κατσαβίδια
- 55. Ταφ
- 56. Μαλύβια - Μαρκαδόροι - Σημαδευτήρια - Προκοβγάλες
- 57. Μύτες κατσαβιδιών
- 62. Πένσες
- 63. Πένσες ασφαλειών
- 66. Μυτοτσίμπιδα - Τσιμπίδες
- 68. Κοφτάκια
- 70. Εμπροσθοκόφτες - Απογυμνωτές
- 73. Πρέσες βυσμάτων
- 74. Κλειδιά φίλτρου
- 75. Ταπόκλειδα - Φιλτρόκλειδα
- 76. Πένσες κολιέδων
- 77. Γκαζοτανάλιες - Τσιμπίδες - Κάβουρες
- 78. Ψαλίδια PVC - Ταπόνια - Κουρμπαδόροι
- 80. Γερμανικά - Γαλλικά - Γαντζόκλειδα
- 81. Γερμανοπολύγωνα κλειδιά
- 82. Πολύγωνα κλειδιά
- 83. Πίπες - Ταπόκλειδα - κλειδιά πείρου
- 84. Σετ κλειδιά
- 85. Κλειδιά allen
- 88. Κλειδιά torx - polydrive - XZN
- 89. Σετ καρυδάκια
- 93. Σετ καρυδάκια - Σετ εργαλεία
- 95. Σετ καρυδάκια χωρίς καστάνια
- 96. Καστάνιες
- 97. Προεκτάσεις - Μανέλες
- 98. Κατσαβίδια για καρυδάκια - Αντάπτορες - Σπαστά
- 99. Καρυδάκια μεμονωμένα
- 105. Αερόκλειδα - Αεροκαστάνιες
- 106. Καρυδάκια αερόκλειδου
- 110. Διαμαντοτρύπανα
- 113. Ποτηροκορώνες
- 114. Τρυπάνια αέρος
- 117. Φρεζάκια - Κεντραδόροι
- 118. Τρυπάνια γυαλιού - ξύλου
- 119. Σετ τρυπάνια
- 120. Φρεζάκια

- 121. Βύσματα ξύλου - Στηρίγματα σωλήνα
- 122. Τσέρκια - Βύσματα τοίχου - γυψοσανίδας
- 125. Μεταλλικά βύσματα - Αγκύρια
- 127. Γάντζοι - Θηλιές - Κρίκοι - Στριφονόβιδες
- 128. Στριφόνια - Μπετονόβιδες
- 130. Τζαμοκόφτες - Βεντούζες - Καρφωτικά - Πιάτα
- 131. Χωνιά - Κανάτες - Μπιτόνια - Pressol
- 132. Ταινίες συσκευασίας - φιλμ
- 133. Φαλτσέτες
- 134. Ανταλλακτικές λεπίδες
- 135. Ανταλλακτικές λεπίδες σέγας
- 138. Ανταλλακτικές λεπίδες σπαθοσέγας
- 140. Ψαλίδια
- 141. Ψαλίδια λαμαρίνας
- 142. Πριόνια χειρός
- 143. Πριονοκορδέλες - Δίσκοι
- 149. Κοπτικά τρύπας - Ποτηροκορώνες - Ποτηροτρύπανα
- 151. Κώνικες φρέζες - Κεντραδόροι
- 152. Βελόνια - Καλέμια - Κοπίδια SDS
- 153. Μαχαίρια τόννου
- 154. Κονδύλια
- 155. Βοηθητικά εργαλεία
- 156. Αλοιφές κοπτικών - Σπρέι
- 157. Σπρέι - Γράσα
- 159. Κόλλες - Καθαριστικά
- 161. Αλοιφές γυαλισματος
- 162. Σπρέι χρώμα
- 164. Μετροταινίες
- 165. Μεζούρες - Ρίγες - Γωνίες
- 166. Παχύμετρα - Μικρόμετρα
- 167. Φίλλερ - Σπειρόμετρα - Κουμπάσα
- 168. Εξολκείς
- 178. Εργαλεία αυτοκινήτου
- 179. Κρουστικά κατσαβίδια
- 180. Περτσινάδοροι - Περτσίνια
- 181. Περτσίνια - Κεντραδόροι
- 182. Χτυπητά γράμματα - Στένσιλ
- 183. Φλαντζοκόφτες - Σγρόπιες
- 184. Κολαούζα
- 188. Φιλιέρες
- 190. Μανέλες κολαούζων - φιλιέρας
- 191. Ελατήρια επιδιόρθωσης πάσων
- 192. Κιτ πάσων - Κώνοι - Φωλιές
- 193. Τσοκ
- 195. Δυναμόκλειδα
- 199. Σφιγκτήρες μαραγκών
- 201. Μόρσες - Σαπόρτ - Αμόνια
- 203. Λειαντικά δραπάνου
- 205. Συρματόβουρτσες
- 210. Λίμες - Γυαλιά ηλεκτροκόλλησης
- 211. Ανταλλακτικά ηλεκτροκόλλησης
- 213. Λουκέτα
- 214. Κλειδαριές - Κύλινδροι
- 215. Κύλινδροι - Κυπριά - Σούστες πόρτας
- 216. Σφυριά - Βαριοπούλες - Ματσόλες
- 217. Σκύλες - Κοπίδια - Βελόνια
- 218. Φτυάρια - Μυστριά - Μακαράδες - Κουβάδες

- 219. Πιστόλια σιλικόνης - αφρού - Μίξερ - Κουβάδες
- 220. Εργαλεία γυψοσανίδας
- 221. Εργαλεία γυψοσανίδας - Σπάτουλες
- 222. Σπάτουλες - Ξύστρες - Αλφάδια
- 223. Αλφάδια
- 224. Γρασαδοράκια
- 225. Γρασαδόροι
- 226. Σφήνες - Τραπεζοειδείς ντίζες
- 227. Πόμολα - Μαργαρίτες
- 229. Βολάν - Χειρολαβές - Μεντεσέδες
- 230. Πέλματα βάσεις
- 231. Τάπες - Μαγνήτες νεοδιμίου
- 232. Βιδωτά κολάρα
- Ανοξειδωτα**
- 233. Βιδωτά κολάρα ανοξειδωτα
- 234. Εξάγωνες βίδες
- 236. Περικόχλια
- 237. Ροδέλες
- 238. Μηχανόβιδες - Κασονόβιδες
- 240. Βύσματα
- 241. Αλενόβιδες
- 243. Νοβοπανόβιδες - Στριφόνια
- 244. Λαμαρινόβιδες - Τρυπανόβιδες
- 245. Ασφάλειες - Κοπίλιες - Σφήνες
- 246. Ασφάλειες - Μποζόνια - Καβίλιες
- 247. Περόνες - Πίροι - Γάντζοι S - Δέλτα
- 248. Κρίκοι - Περτσίνια
- 249. Μεντεσέδες
- 254. Καταβάτες - Σύρτες
- 257. Σύρτες
- 259. Γωνίες - Λάμες - Χειρολαβές
- 260. Στηρίγματα τζαμιών - Στοπ πόρτας
- 261. Ναυτικά κλειδιά
- 263. Συρματόσχοινα - Σφυγκτήρες - Ταλουρίτ
- 264. Άκρα συρματόσχοινου
- 265. Άκρα πρέσσας
- 267. Εντατήρες συρματόσχοινων
- 270. Γάντζοι αλυσίδας
- 271. Στριφτάρια - Πυροσβεστικοί γάντζοι
- 273. Κρεμάστρες - Στραβόβιδες - Γαντζόβιδες
- 274. Ράουλα - Τροχαλίες
- 275. Χούφτες - Ωμέγα
- 276. Μάπες
- 277. Βιδωθηλιές - U-bolts
- 278. Περσίδες
- 279. Αεραγωγοί - Σύρμα - Σίτες - Πλέγματα
- 280. Τάπες - Οπές - Βαλβίδες
- 281. Εξαρτήματα σωλήνων
- 286. Εξαρτήματα υδραυλικών σωλήνων
- 287. Κοτσανέλα
- 288. Κοτσανέλα - Δέστρες - Γλύστρες
- 289. Στριφτάρια - Άγκυρες - Αλυσίδες

Ρούχα εργασίας



Παπούτσια



Παντελόνια εργασίας



Μπουφάν



Γυαλιά προστασίας



Ωτασπίδες



Γάντια



Προστασία πτώσης

Ταμπακιέρες - Εργαλειοθήκες - Τσάντες - Σακίδια - Ποδιές - Μπαούλα



Ταμπακιέρες



Βαλίτσες



Εργαλειοθήκες



Τσάντες εργαλείων



Θήκες ζώνης



Μπανάνες μέσης



Μπαούλα

Κατσαβίδια - Μύτες - Πένσες - Κόφτες - Μυτοτσιμπίδα - Προσέλες - Απογυμνωτές - Πρέσες

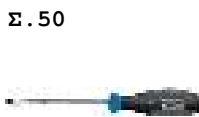

Κατσαβίδια



Μύτες κατσαβιδιών



Πένσες



Κόφτες



Μυτοτσιμπίδα



Απογυμνωτές καλωδίων



Πρέσες ακροδεκτών

Γκαζοτανάλιες - Τσιμπίδες - Κάβουρες - Γκριπ - Ψαλίδια σωλήνων - Κουρμαδόροι



Γκαζοτανάλιες



Γκριπ



Κάβουρες αλουμινίου



Ψαλίδια τουμποράματος



Κουρμαδόροι

Κλειδιά

Σ. 80



Γερμανικά

Σ. 81



Γερμανοπολύγωνα

Σ. 83



Σαληνωτά κλειδιά

Σ. 80



Γαλλικά κλειδιά

Σ. 55



Ταφ

Σ. 85



Κλειδιά γωνιακά allen, torx κλπ

Καρυδάκια - Σετ εργαλεία - Δυναμόκλειδα - Αερόκλειδα



Καρυδάκια



Καστάνιες



Προεκτάσεις καστάνιες



Σετ εργαλεία

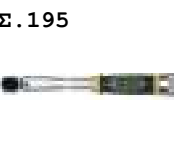

Δυναμόκλειδα



Πολλαπλασιαστής



Αερόκλειδα

Φιλτρόκλειδα - Εξολκείς - Κολαούζα - Φιλιέρες - Κρουστικά κατσαβίδια - Εργαλεία μηχανικών



Κλειδιά φίλτρου



Εξολκείς



Κολαούζα



Φιλιέρες



Κρουστικά κατσαβίδια



Εργαλεία μηχανικών



Εξαγωγείς κλιπ

Σφυριά - Ματσόλες - Βαριές - Σκύλες - Σκαρπέλα - Καλέμια

Σ. 216



Σφυριά

Σ. 216



Βαριοπούλες

Σ. 217



Κοπίδια

Σ. 183



Σγρόπιες

Σ. 181



Ζουμπάδες

Σ. 216



Ματσόλες

Σ. 217



Σκύλες

Σφιγκτήρες - Μόρσες

Σ. 199



Μάνδαλα

Σ. 130



Βεντούζες τζαμιών

Σ. 199



Σφιγκτήρες μαραγκών

Σ. 221



Τηλεσκοπικοί βραχίονες

Σ. 201



Μόρσες

Σ. 201



Σαπόρτ

Φαλτσέτες - Ψαλίδια - Πριόνια

Σ. 133



Φαλτσέτες

Σ. 130



Τζαμοκόφτες

Σ. 140



Ψαλίδια - Λαμαρινογάιδα

Σ. 142



Πριόνια

Σ. 183



Φλαντζοκόφτες

Σ. 48



Σκαρπέλα ξύλου

Σ. 49



Ακονόπετρες

Λειαντικά - Συρματόβουρτσες - Λίμες

Σ. 208



Συρματόβουρτσες

Σ. 209



Τουμπόβουρτσες

Σ. 210



Λίμες

Σ. 204



Σμυριδόπετρες δραπεάνου

Σ. 204



Κετσέδες

Σ. 205



Συρματόβουρτσες

Σ. 161



Αλοιφές γυαλίσματος

Περσιναδόροι - Περτσίνια

Σ. 180



Περσιναδόροι

Σ. 181



Περτσίνια

Σ. 248



Περτσίνια inox

Σ. 248



Περτσίνια μασίφ

Σ. 248



Περτσίνια με πάσο

Σ. 220



Πρέσες γυψοσανίδων

Σ. 124



Πρέσες αρθρωτών βυσμάτων

Όργανα μέτρησης

Σ. 164



Μετροταινίες

Σ. 165



Γωνίες σιδηρουργού

Σ. 167



Γωνίες Στέλλα

Σ. 167



Κουμπάσα

Σ. 166



Παχύμετρα

Σ. 167



Φύλλερ

Σ. 167



Μοιρογνωμόνια

Εργαλεία οικοδόμων

Σ. 223



Αλφάδια

Σ. 219



Πιστόλια σιλικόνης

Σ. 219



Πιστόλια αφρού πολουρεθάνης

Σ. 221



Σπάτουλες

Σ. 220



Εργαλεία γυψοσανίδων

Σ. 218



Κουβάδες

Γρασαδόροι - Λαδικά Χωνιά - Μπετόνια - Pressol

Σ. 225



Γρασαδόροι

Σ. 224



Γρασαδοράκια

Σ. 158



Γράσα

Σ. 225



Λαδικά

Σ. 131



Χωνιά

Σ. 131



Κανάτες
ογκομέτρησης

Σ. 131



Μπετόνια

Κολλητήρια - Φλόγιστρα - Οξυγονοκολλήσεις - Υλικά ηλεκτροκόλλησης - Καλάι

Σ. 39



Κολλητήρια

Σ. 39



Καλάι

Σ. 39



Σολντερίνη

Σ. 41



Φλόγιστρα

Σ. 44



Οξυγονοκολλήσεις

Σ. 44



Φιάλες αερίου

Σ. 211



Υλικά
ηλεκτροκόλλησης

Σχοινιά - Ιμάντες - Βίντσια

Σ. 132



Ταινίες
αυτοκόλλητες

Σ. 132



Φιλμ χειρός

Σ. 46



Σχοινιά

Σ. 47



Ιμάντες

Εργαλεία σημαδέματος - Προκοβγάλτες

Σ. 56



Μολύβια

Σ. 56



Μαρκαδόροι
ανεξίτηλοι

Σ. 56



Σημαδευτήρια

Σ. 56



Σουβλιά

Σ. 223



Αλφάδια

Σ. 182



Χτυπητά γράμματα

Σ. 182



Στένσιλ

Τρυπάνια - Φρέζες

Σ. 114



Τρυπάνια

Σ. 150



Ποτηροτρυπάνια

Σ. 149



Κοπτικά τρύπας
μετάλλων

Σ. 117



Φρεζάκια

Σ. 154



Κονδύλια

Σ. 153



Μαχαίρια τόννου

Σ. 193



Τσοκ

Δίσκοι

Σ. 145



Δίσκοι κοπής -
λείανσης

Σ. 135



Λεπίδες σέγας

Σ. 138



Λεπίδες
σαβοσέγας

Σ. 145



Πριονοκορδέλες

Σ. 156



Αλοιφές κοπτικών

Χρώματα - Σπρέι - Διαλυτικά - Καθαριστικά - Λιπαντικά

Σ. 162



Σπρέι χρώμα

Σ. 157



Σπρέι
αντισκωριακά

Σ. 160



Καθαριστικά

Σ. 161



Αλοιφές
γαλισματος

Σ. 159



Κόλλες

Σ. 158



Γράσα

Σ. 156



Σαπουνέλια

Υλικά στήριξης - Πόμολα - Πέλματα - Κολάρα

Σ. 122



Βύσματα

Σ. 259



Γωνίες

Σ. 259



Γωνίες ραφιών

Σ. 227



Πόμολα

Σ. 230



Πόδια βιδωτά

Σ. 260



Στοπ πόρτας

Σ. 232



Σφιγκτήρες κολάρων

Ανοξείδωτες βίδες - παξιμάδια - ροδέλες - ασφάλειες

Σ. 234



Βίδες inox

Σ. 238



Μηχανόβιδες inox

Σ. 243



Νοβοπανόβιδες

Σ. 237



Ροδέλες inox

Σ. 235



Περικόχλια inox

Σ. 245



Ασφάλειες άξονος

Σ. 245



Σφήνες inox

Ανοξείδωτοι μεντεσέδες - σύρτες - καταβάτες - ναυτικά κλειδιά - γάντζοι - στριφτάρια

Σ. 246



Μεντεσέδες

Σ. 257



Σύρτες

Σ. 254



Καταβάτες

Σ. 261



Ναυτικά κλειδιά

Σ. 271



Γάντζοι

Σ. 270



Στριφτάρια

Ανοξείδωτα συρματόσχοινα - αλυσίδες

Σ. 263



Συρματόσχοινα

Σ. 263



Ταλουρίτ

Σ. 263



Στοπ συρματόσχοινο

Σ. 274



Ράουλα

Σ. 289



Αλυσίδες

Σ. 261



Σύνδεσμοι αλυσίδας

Σ. 270



Γάντζοι αλυσίδας

Ανοξείδωτες σίτες - πλέγματα - σύρματα - περσίδες

Σ. 279



Σίτες

Σ. 279



Πλέγματα

Σ. 279



Σύρμα

Σ. 278



Περσίδες

Ανοξείδωτα εξαρτήματα σκαφών

Σ. 280



Σχάρες

Σ. 281



Βάσεις κεραίας

Σ. 282



Βάσεις κάγκελων

Σ. 285



Αγκράφες

Σ. 287



Κοτσανέλα

Σ. 289



Άγκυρες

Ανοξείδωτα υδραυλικά εξαρτήματα

Σ. 286



Γωνίες

Σ. 286



Μούφες

Σ. 286



Τάπες

Σ. 286



Ρακόρ

Σ. 286



Συστολές

Σ. 286



Σωληνομαστοί

















































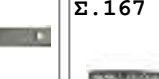











Σ. 286























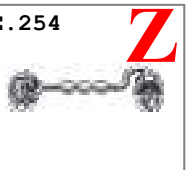







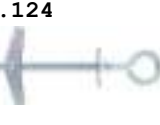



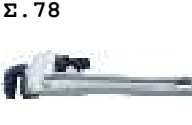













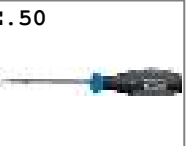
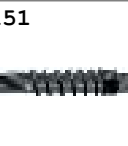









































































Βάνες

Α Β Γ Δ Ε Ζ Η Θ Ι Κ Λ Μ Ν Ξ Ο Π Ρ Σ Τ Υ Φ Χ Ψ Ω































































<p>Σ. 277</p>  <p>U-bolts</p>	<p>Σ. 285</p> <p>A</p>  <p>Αγκράφες</p>	<p>Σ. 289</p>  <p>Αγκυρες</p>	<p>Σ. 279</p>  <p>Αεραγωγοί</p>	<p>Σ. 105</p>  <p>Αεροκαστάνιες</p>	<p>Σ. 105</p>  <p>Αερόκλειδα</p>	<p>Σ. 23</p>  <p>Αδιάβροχα</p>
<p>Σ. 265</p>  <p>Άκρα πρέσσας</p>	<p>Σ. 264</p>  <p>Άκρα συρματόσχοινο</p>	<p>Σ. 49</p>  <p>Ακονόπετρες</p>	<p>Σ. 176</p>  <p>Ακουστικά κινητήρα</p>	<p>Σ. 241</p>  <p>Αλενόβιδες</p>	<p>Σ. 85</p>  <p>Άλλεν κλειδιά</p>	<p>Σ. 161</p>  <p>Αλοιφές γυαλίσματος</p>
<p>Σ. 156</p>  <p>Αλοιφές κοπτικών</p>	<p>Σ. 223</p>  <p>Αλφάδια</p>	<p>Σ. 289</p>  <p>Αλυσίδες</p>	<p>Σ. 201</p>  <p>Αμόνια</p>	<p>Σ. 27</p>  <p>Αναδέτες σύνδεσης</p>	<p>Σ. 46</p>  <p>Αναπτήρες BBQ</p>	<p>Σ. 27</p>  <p>Ανασχετήρες ασφαλείας</p>
<p>Σ. 40</p>  <p>Ανταλλακτικά πυρογράφου</p>	<p>Σ. 40</p>  <p>Ανταλλακτικά χαβιά αερίου</p>	<p>Σ. 43</p>  <p>Αντάπτορες αερίου</p>	<p>Σ. 61</p>  <p>Αντάπτορες βιολόγων</p>	<p>Σ. 151</p>  <p>Αντάπτορες ποτηροτρύπανων</p>	<p>Σ. 173</p>  <p>Αντίστροφα κολαούζα</p>	<p>Σ. 131</p>  <p>Αντλίες υγρών</p>
<p>Σ. 71</p>  <p>Απογυμνωτές καλωδίων</p>	<p>Σ. 160</p>  <p>Αποφρακτικά υγρά</p>	<p>Σ. 74</p>  <p>Αρπαγες</p>	<p>Σ. 245</p>  <p>Ασφάλειες άξονος</p>	<p>Σ. 247</p>  <p>Ασφάλειες εντατήρα</p>	<p>Σ. 246</p>  <p>Ασφάλειες μισοφέγγαρες</p>	<p>Σ. 247</p>  <p>Ασφάλειες πίρου</p>
<p>Σ. 245</p>  <p>Ασφάλειες τρύπας</p>	<p>Σ. 159</p>  <p>Ασφαλιστικά μπουλονιών</p>	<p>Σ. 159</p>  <p>Ατσαλοστοκοι</p>	<p>Σ. 165</p>  <p>Αυτοκόλλητες μεζούρες</p>	<p>Σ. 280</p> <p>B</p>  <p>Βαλβίδες εξαέρωσης</p>	<p>Σ. 33</p>  <p>Βαλίτσες</p>	<p>Σ. 286</p>  <p>Βάνες</p>
<p>Σ. 216</p>  <p>Βαριοπούλες</p>	<p>Σ. 285</p>  <p>Βάσεις κάθεταις</p>	<p>Σ. 281</p>  <p>Βάσεις κεραίας</p>	<p>Σ. 285</p>  <p>Βάσεις κούρμπα</p>	<p>Σ. 282</p>  <p>Βάσεις λοξές</p>	<p>Σ. 285</p>  <p>Βάσεις με βίδα - πύρο</p>	<p>Σ. 283</p>  <p>Βάσεις σπαστές για ποτήρι</p>
<p>Σ. 283</p>  <p>Βάσεις σωλήνα σκάλας</p>	<p>Σ. 217</p>  <p>Βελόνια</p>	<p>Σ. 152</p>  <p>Βελόνια SDS</p>	<p>Σ. 159</p>  <p>Βενζινόκολλες</p>	<p>Σ. 174</p>  <p>Βεντούζες λείανσης βαλβίδων</p>	<p>Σ. 130</p>  <p>Βεντούζες τζαμιών</p>	<p>Σ. 19</p>  <p>Βερμούδες</p>
<p>Σ. 123</p>  <p>Βίδες θηλιές με βύσμα</p>	<p>Σ. 125</p>  <p>Βίδες ντίζες</p>	<p>Σ. 277</p>  <p>Βιδοθηλιές inox</p>	<p>Σ. 232</p>  <p>Βιδωτά κολάρα σφυγκτήρες</p>	<p>Σ. 233</p>  <p>Βιδωτά κολάρα σφυγκτήρες inox</p>	<p>Σ. 229</p>  <p>Βολάν</p>	<p>Σ. 123</p>  <p>Βύσματα βαρέως τύπου</p>

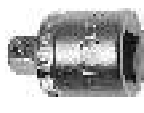





























































<p>Σ. 122</p>  <p>Βύσματα γυψοσανίδας</p>	<p>Σ. 124</p>  <p>Βύσματα θερμοπρόσοψης</p>	<p>Σ. 123</p>  <p>Βύσματα με εξάγωνο άξονα</p>	<p>Σ. 125</p>  <p>Βύσματα ντιζας</p>	<p>Σ. 121</p>  <p>Βύσματα ξύλου</p>	<p>Σ. 240</p>  <p>Βύσματα ξύλου inox</p>	<p>Σ. 122</p>  <p>Βύσματα τοίχου</p>
<p>Σ. 126</p>  <p>Βύσματα χτυπητά</p>	<p>Σ. 240</p>  <p>Βύσματα χτυπητά inox</p>	<p>Σ. 125</p>  <p>Γαλβανιζέ βίδες - βύσματα</p>	<p>Σ. 80</p>  <p>Γαλλικά κλειδιά</p>	<p>Σ. 247</p>  <p>Γάντζοι "S"</p>	<p>Σ. 270</p>  <p>Γάντζοι αλυσίδας</p>	<p>Σ. 273</p>  <p>Γάντζοι βίδα</p>
<p>Σ. 124</p>  <p>Γάντζοι γυψοσανίδας</p>	<p>Σ. 270</p>  <p>Γάντζοι με πύρο</p>	<p>Σ. 272</p>  <p>Γάντζοι με στριφτάρι</p>	<p>Σ. 27</p>  <p>Γάντζοι πυροσβεστικοί</p>	<p>Σ. 80</p>  <p>Γαντζόκλειδα</p>	<p>Σ. 29</p>  <p>Γάντια</p>	<p>Σ. 72</p>  <p>Γδάρτες καλωδίων</p>
<p>Σ. 80</p>  <p>Γερμανικά κλειδιά</p>	<p>Σ. 81</p>  <p>Γερμανοπολύγωνα</p>	<p>Σ. 173</p>  <p>Γέφυρες εσωτερικών εξολκείων</p>	<p>Σ. 172</p>  <p>Γέφυρες πιάτων ρουλεμάν</p>	<p>Σ. 22</p>  <p>Γλέκα</p>	<p>Σ. 46</p>  <p>Γκαζάκια υγραερίου</p>	<p>Σ. 77</p>  <p>Γκαζοτανάλιες</p>
<p>Σ. 78</p>  <p>Γκριπ</p>	<p>Σ. 237</p>  <p>Γκρόβερ inox</p>	<p>Σ. 288</p>  <p>Γλύστρες</p>	<p>Σ. 158</p>  <p>Γράσα</p>	<p>Σ. 224</p>  <p>Γρασαδοράκια Γρασαδόροι</p>	<p>Σ. 210</p>  <p>Γυαλιά ηλεκτροκόλλησης</p>	<p>Σ. 25</p>  <p>Γυαλιά προστασίας</p>
<p>Σ. 259</p>  <p>Γωνίες</p>	<p>Σ. 273</p>  <p>Γωνίες βίδα</p>	<p>Σ. 259</p>  <p>Γωνίες πλακέ</p>	<p>Σ. 259</p>  <p>Γωνίες ραφιών</p>	<p>Σ. 165</p>  <p>Γωνίες σιδηρουργού</p>	<p>Σ. 167</p>  <p>Γωνίες Στέλλα</p>	<p>Σ. 259</p>  <p>Γωνίες τραπεζοειδείς</p>
<p>Σ. 283</p>  <p>Γωνίες σωλήνων σκάφους</p>	<p>Σ. 247</p>  <p>Δέλτα</p>	<p>Σ. 288</p>  <p>Δέστρες</p>	<p>Σ. 167</p>  <p>Διαβήτες</p>	<p>Σ. 161</p>  <p>Διαλυτικά νίτρου</p>	<p>Σ. 148</p>  <p>Διαμαντόδισκοι</p>	<p>Σ. 113</p>  <p>Διαμαντοκεφαλές</p>
<p>Σ. 137</p>  <p>Διαμαντολεπίδες σέγας</p>	<p>Σ. 139</p>  <p>Διαμαντολεπίδες σπαθοσέγας</p>	<p>Σ. 110</p>  <p>Διαμαντοτρύπανα</p>	<p>Σ. 285</p>  <p>Διαμπερείς σωλήνες</p>	<p>Σ. 170</p>  <p>Δίτοδα σέτ εξολκείων</p>	<p>Σ. 145</p>  <p>Δίσκοι κοπής - λείανσης</p>	<p>Σ. 50</p>  <p>Δοκιμαστικά κατασβίδια</p>
<p>Σ. 195</p>  <p>Δυναμόκλειδα</p>	<p>Σ. 46</p>  <p>Ελαστικά σχοινιά</p>	<p>Σ. 191</p>  <p>Ελατήρια επιδιόρθωσης</p>	<p>Σ. 186</p>  <p>Ελικοειδή κολαούζα</p>	<p>Σ. 70</p>  <p>Εμπροσθοκόφτες</p>	<p>Σ. 267</p>  <p>Εντάτηρες συρματοσχοινών</p>	<p>Σ. 234</p>  <p>Εξάγωνες βίδες</p>
<p>Σ. 171</p>  <p>Εξολκείς αδρανείας</p>						

<p>Σ. 170</p>  <p>Εξολκείς ακρόμπαραν</p>	<p>Σ. 174</p>  <p>Εξολκείς βαλβίδων</p>	<p>Σ. 168</p>  <p>Εξολκείς δίποδοι - τρίποδοι</p>	<p>Σ. 173</p>  <p>Εξολκείς ελατηρίων</p>	<p>Σ. 173</p>  <p>Εξολκείς μπουζονιών</p>	<p>Σ. 172</p>  <p>Εξολκείς ρουλεμάν</p>	<p>Σ. 28</p>  <p>Επιγονατίδες</p>
<p>Σ. 134</p>  <p>Επιφάνειες κοπής</p>	<p>Σ. 40</p>  <p>Εργαλεία φελιζόλ</p>	<p>Σ. 30</p>  <p>Εργαλειοθήκες</p>	<p>Σ. 24</p>  <p>Εσθερμικά</p>	<p>Σ. 155</p>  <p>Εύκαμπτα σπирάλ - αρπάγες</p>	<p>Σ. 254</p>  <p>Ζεμπερέκια πόρτας</p>	<p>Σ. 181</p>  <p>Ζουμπάδες</p>
<p>Σ. 121</p>  <p>Ζυγκιά</p>	<p>Σ. 19</p>  <p>Ζώνες</p>	<p>Σ. 27</p>  <p>Ζώνες ανάσχεσης πτώσης</p>	<p>Σ. 212</p>  <p>Ηλεκτρόδια</p>	<p>Σ. 36</p>  <p>Θήκες ζώνης</p>	<p>Σ. 30</p>  <p>Θήκες υλικών</p>	<p>Σ. 36</p>  <p>Θήκες κινητών - tablet</p>
<p>Σ. 124</p>  <p>Θηλίες γυροσανίδας</p>	<p>Σ. 123</p>  <p>Θηλίες με βύσμα</p>	<p>Σ. 47</p>  <p>Ιμάντες</p>	<p>Σ. 246</p>  <p>Καβίλιες</p>	<p>Σ. 78</p>  <p>Κάβουρες αλουμινίου</p>	<p>Σ. 160</p>  <p>Καθαριστικά</p>	<p>Σ. 39</p>  <p>Καλάι</p>
<p>Σ. 217</p>  <p>Καλέμια</p>	<p>Σ. 152</p>  <p>Καλέμια SDS</p>	<p>Σ. 19</p>  <p>Κάλτσες</p>	<p>Σ. 131</p>  <p>Κανάτες ογκομέτρησης</p>	<p>Σ. 120</p>  <p>Καρβίδια</p>	<p>Σ. 95</p>  <p>Καρυδάκια</p>	<p>Σ. 89</p>  <p>Καρυδάκια σετ</p>
<p>Σ. 55</p>  <p>Καρυδάκια Ταφ</p>	<p>Σ. 239</p>  <p>Κασονόβιδες inox</p>	<p>Σ. 96</p>  <p>Καστάνιες</p>	<p>Σ. 190</p>  <p>Καστάνιες κολαούζων</p>	<p>Σ. 254</p>  <p>Καταβάτες</p>	<p>Σ. 50</p>  <p>Κατσαβίδια</p>	<p>Σ. 151</p>  <p>Κεντραδόροι κοπτικών</p>
<p>Σ. 117</p>  <p>Κεντραδόροι τόννου</p>	<p>Σ. 156</p>  <p>Κεριά κοπτικών</p>	<p>Σ. 140</p>  <p>Κλαδευτήρια</p>	<p>Σ. 214</p>  <p>Κλειδαριές</p>	<p>Σ. 85</p>  <p>Κλειδιά γωνιακά allen, torx κλπ</p>	<p>Σ. 83</p>  <p>Κλειδιά με πύρους</p>	<p>Σ. 74</p>  <p>Κλειδιά φίλτρου</p>
<p>Σ. 184</p>  <p>Κολαούζα</p>	<p>Σ. 159</p>  <p>Κόλλες</p>	<p>Σ. 39</p>  <p>Κολλητήρια</p>	<p>Σ. 154</p>  <p>Κονδύλια</p>	<p>Σ. 217</p>  <p>Κοπίδια</p>	<p>Σ. 152</p>  <p>Κοπίδια SDS</p>	<p>Σ. 245</p>  <p>Κοπίλιες inox</p>
<p>Σ. 149</p>  <p>Κοπτικά τρύπας μετάλλων</p>	<p>Σ. 19</p>  <p>Κορδόνια παπουτσιών</p>	<p>Σ. 287</p>  <p>Κοτσανέλα</p>	<p>Σ. 218</p>  <p>Κουβάδες</p>	<p>Σ. 79</p>  <p>Κουρμπαδόροι</p>	<p>Σ. 167</p>  <p>Κουμπάσα</p>	

<p>Σ . 68</p>  <p>Κόφτες καλωδίων</p>	<p>Σ . 171</p>  <p>Κόφτες</p>	<p>Σ . 70</p>  <p>Κόφτες σύρματος</p>	<p>Σ . 28</p>  <p>Κράνη ασφαλείας</p>	<p>Σ . 273</p>  <p>Κρεμάστρες</p>	<p>Σ . 248</p>  <p>Κρίκοι</p>	<p>Σ . 179</p>  <p>Κρουστικά κατασβήδια</p>
<p>Σ . 214</p>  <p>Κύλινδροι κλειδαριών</p>	<p>Σ . 215</p>  <p>Κυπρί</p>	<p>Σ . 151</p>  <p>Κόνικες φρέζες</p>	<p>Σ . 192</p>  <p>Κόνιοι</p>	<p>Σ . 210</p>  <p>Λαβές λίμας</p>	<p>Σ . 45</p>  <p>Λαβές οξυγονοκόλλησης</p>	<p>Σ . 209</p>  <p>Λαβές τουμπόβουρτσας</p>
<p>Σ . 225</p>  <p>Λαδικά</p>	<p>Σ . 244</p>  <p>Λαμαρινόβιδες</p>	<p>Σ . 259</p>  <p>Λάμες πλακέ</p>	<p>Σ . 144</p> <p>Λάμες σιδηροπρίονου</p>	<p>Σ . 171</p>  <p>Λεβιέδες ελαστικών</p>	<p>Σ . 228</p>  <p>Λεβιέδες κασάνιας</p>	<p>Σ . 203</p>  <p>Λειαντικά δραπεύου</p>
<p>Σ . 135</p>  <p>Λεπίδες σέγας</p>	<p>Σ . 138</p>  <p>Λεπίδες σπαθοσέγας</p>	<p>Σ . 134</p>  <p>Λεπίδες σπαστές - τραπεζοειδείς</p>	<p>Σ . 210</p>  <p>Λίμες</p>	<p>Σ . 156</p>  <p>Λιπαντικά κοπτικών</p>	<p>Σ . 213</p>  <p>Λουκέτα</p>	<p>Σ . 231</p>  <p>Μαγνήτες</p>
<p>Σ . 101</p>  <p>Μαγνητικά καρδύακια</p>	<p>Σ . 130</p>  <p>Μαγνητικά πιάτα</p>	<p>Σ . 61</p>  <p>Μαγνητικοί αντάπτορες</p>	<p>Σ . 155</p>  <p>Μαγνητιστές - απομαγνητιστές</p>	<p>Σ . 218</p>  <p>Μακαράδες</p>	<p>Σ . 199</p>  <p>Μάνδαλα</p>	<p>Σ . 97</p>  <p>Μανέλες</p>
<p>Σ . 190</p>  <p>Μανέλες κολαούζων</p>	<p>Σ . 254</p>  <p>Μάνταλα πόρτας</p>	<p>Σ . 276</p>  <p>Μάπες</p>	<p>Σ . 56</p>  <p>Μαρκαδόροι ανεξίτηλοι</p>	<p>Σ . 211</p>  <p>Μάσκες ηλεκτροκόλλησης</p>	<p>Σ . 25</p>  <p>Μάσκες γυαλιά</p>	<p>Σ . 216</p>  <p>Ματσακόνια</p>
<p>Σ . 216</p>  <p>Ματσόλες</p>	<p>Σ . 153</p>  <p>Μαχαίρια τόνου</p>	<p>Σ . 45</p>  <p>Μειωτήρες αερίου</p>	<p>Σ . 249</p>  <p>Μεντεσέδες</p>	<p>Σ . 125</p>  <p>Μεταλλικά βόσματα</p>	<p>Σ . 164</p>  <p>Μετροταινίες</p>	<p>Σ . 238</p>  <p>Μηχανόβιδες inox</p>
<p>Σ . 166</p>  <p>Μικρόμετρα</p>	<p>Σ . 167</p>  <p>Μοιρογνωμόνια</p>	<p>Σ . 44</p>  <p>Μολυβδοκόλληση</p>	<p>Σ . 56</p>  <p>Μολύβια</p>	<p>Σ . 132</p>  <p>Μονωτικές ταινίες</p>	<p>Σ . 201</p>  <p>Μόρσες</p>	<p>Σ . 38</p>  <p>Μπανάνες μέσης</p>
<p>Σ . 34</p>  <p>Μπαούλα</p>	<p>Σ . 128</p>  <p>Μπετόνια</p>	<p>Σ . 128</p>  <p>Μπετονόβιδες</p>	<p>Σ . 71</p>  <p>Μπετογάλιδα</p>	<p>Σ . 246</p>  <p>Μποζόνια</p>	<p>Σ . 18</p>  <p>Μποτάκια ασφαλείας</p>	

Σ. 22  Μπουφάν	Σ. 44  Μπρουντζοκόλληση	Σ. 57  Μύτες κατσαβιδιών	Σ. 66  Μυτοσίμιδα	Σ. 261  Ναυτικά κλειδιά	Σ. 286  Νίτελ	Σ. 243  Νοβοπανόβιδες
Σ. 235  Ντίζες	Σ. 226  Ντίζες τραπεζοειδείς	Σ. 133  Νυστέρια	Σ. 127  Ευλόβιδες	Σ. 222  Εύστρες	Σ. 183  Εύστρες φλαντζών	Σ. 113  Οδηγοί για ποτηροκρώνες
Σ. 165  Οδόμετρα	Σ. 44  Οξυγονοκόλλησεις	Σ. 280  Οπές κύτους	Σ. 45  Παγίδες φλόγας	Σ. 20  Παντελόνια εργασίας	Σ. 17  Παπούτσια	Σ. 19  Πάτιο παπουτσιών
Σ. 166  Παχύμετρα	Σ. 62  Πένσες	Σ. 63  Πένσες ασφαλειών	Σ. 76  Πένσες κολιέδων	Σ. 62  Πένσες μολυβδοσφραγίδων	Σ. 220  Πεντάλ ανύψωσης	Σ. 235  Περικόχλια
Σ. 246  Περόνες	Σ. 278  Περσίδες	Σ. 180  Περσιναδόροι	Σ. 181  Περτσίνια	Σ. 248  Περτσίνια inox	Σ. 248  Περτσίνια μασίφ	Σ. 248  Περτσίνια με πάσο
Σ. 172  Πηρούνες εξολκέων	Σ. 168  Πιάτα για ρουλεμάν	Σ. 237  Πιατάκια μασίφ	Σ. 178  Πιστόλια αέρος	Σ. 219  Πιστόλια αφρού πολυουρεθάνης	Σ. 219  Πιστόλια σιλικόνης	Σ. 68  Πλαγιοκόφτες
Σ. 279  Πλέγματα	Σ. 230  Πόδια βιδωτά	Σ. 169  Πόδια για εξολκείς	Σ. 82  Πολύγωνα	Σ. 227  Πόμολα	Σ. 194  Πόντες τόννου	Σ. 281  Ποτήρια σωλήνα
Σ. 113  Ποτηροκρώνες	Σ. 150  Ποτηροτρύπανα	Σ. 72  Πρέσες ακροδεκτών	Σ. 220  Πρέσες γυψοσανίδων	Σ. 220  Πριόνια γυψοσανίδας	Σ. 142  Πριόνια μετάλλου	Σ. 143  Πριόνια ξύλου
Σ. 145  Πριονοκορδέλες	Σ. 142  Πριονόλαμες	Σ. 224  Προεκτάσεις γρασαδόρου	Σ. 97  Προεκτάσεις καστανίας	Σ. 67  Προσέλες	Σ. 41  Πυρογράφοι	Σ. 247  Πίροι εντατήρα

<p>Σ. 271</p>  <p>Πυροσβεστικοί γάντζοι</p>	<p>Σ. 149</p>  <p>Ράβδοι σιλικόνης</p>	<p>Σ. 286</p>  <p>Ρακόρ</p>	<p>Σ. 274</p>  <p>Ράουλα</p>	<p>Σ. 220</p>  <p>Ράσπες</p>	<p>Σ. 165</p>  <p>Ρίγες</p>	<p>Σ. 263</p>  <p>Ροδάντζες</p>
<p>Σ. 237</p>  <p>Ροδέλες</p>	<p>Σ. 45</p>  <p>Ρυθμιστές αερίου</p>	<p>Σ. 201</p>  <p>Σαπόρτ</p>	<p>Σ. 156</p>  <p>Σαπουνέλαια</p>	<p>Σ. 183</p>  <p>Σγρόπιες</p>	<p>Σ. 54</p>  <p>Σειρές κατασβιδιών</p>	<p>Σ. 93</p>  <p>Σετ εργαλεία</p>
<p>Σ. 89</p>  <p>Σετ καρδιάκια</p>	<p>Σ. 56</p>  <p>Σημαδευτήρια</p>	<p>Σ. 142</p>  <p>Σιδηροπρίονα</p>	<p>Σ. 279</p>  <p>Σίτες</p>	<p>Σ. 219</p>  <p>Σκαπανοτσέκουρα</p>	<p>Σ. 48</p>  <p>Σκαρπέλα</p>	<p>Σ. 24</p>  <p>Σκουφάκια</p>
<p>Σ. 217</p>  <p>Σκύλες</p>	<p>Σ. 204</p>  <p>Σμυριδόπτερες δραπάνου</p>	<p>Σ. 39</p>  <p>Σολντερίνη</p>	<p>Σ. 56</p>  <p>Σουβλιά</p>	<p>Σ. 215</p>  <p>Σούστες πόρτας</p>	<p>Σ. 221</p>  <p>Σπάτουλες</p>	<p>Σ. 210</p>  <p>Σπειρολίμες</p>
<p>Σ. 167</p>  <p>Σπειρόμετρα</p>	<p>Σ. 162</p>  <p>Σπρέι RAL</p>	<p>Σ. 160</p>  <p>Σπρέι αέρας</p>	<p>Σ. 163</p>  <p>Σπρέι βαφής αντισκωριακά</p>	<p>Σ. 157</p>  <p>Σπρέι αντισκωριακά</p>	<p>Σ. 158</p>  <p>Σπρέι γράσο</p>	<p>Σ. 163</p>  <p>Σπρέι τεχνικά</p>
<p>Σ. 283</p>  <p>Σταυροί σωλήνων</p>	<p>Σ. 182</p>  <p>Στένσιλ</p>	<p>Σ. 121</p>  <p>Στηρίγματα σωλήνα</p>	<p>Σ. 260</p>  <p>Στηρίγματα τζαμιών</p>	<p>Σ. 221</p>  <p>Στοκαδόροι</p>	<p>Σ. 260</p>  <p>Στοπ πόρτας</p>	<p>Σ. 263</p>  <p>Στοπ συρματοσχοινο</p>
<p>Σ. 270</p>  <p>Στριφάρια</p>	<p>Σ. 128</p>  <p>Στριφόνια γαλβανιζέ</p>	<p>Σ. 243</p>  <p>Στριφόνια inox</p>	<p>Σ. 127</p>  <p>Στριφονόβιδες γαλβανιζέ</p>	<p>Σ. 243</p>  <p>Στριφονόβιδες inox</p>	<p>Σ. 261</p>  <p>Σύνδεσμοι αλυσίδας</p>	<p>Σ. 282</p>  <p>Σύνδεσμοι σωλήνων</p>
<p>Σ. 264</p>  <p>Συνδετήρες κόμβου</p>	<p>Σ. 279</p>  <p>Σύρμα μαλακό</p>	<p>Σ. 205</p>  <p>Συρματοβουρτσες</p>	<p>Σ. 257</p>  <p>Σύρτες</p>	<p>Σ. 286</p>  <p>Συστολές σωλήνων</p>	<p>Σ. 107</p>  <p>Συστολές για καρδιάκια αέρος</p>	<p>Σ. 98</p>  <p>Συστολές μανέλας</p>
<p>Σ. 226</p>  <p>Σφήνες</p>	<p>Σ. 245</p>  <p>Σφήνες inox</p>	<p>Σ. 192</p>  <p>Σφηνοβγάλτες</p>	<p>Σ. 232</p>  <p>Σφιγκτήρες κολάρων</p>	<p>Σ. 233</p>  <p>Σφιγκτήρες κολάρων inox</p>	<p>Σ. 199</p>  <p>Σφιγκτήρες μαραγκών</p>	<p>Σ. 263</p>  <p>Σφιγκτήρες συρματοσχοινο</p>

Σ. 216  Σφυριά	Σ. 46  Σχοινιά	Σ. 263  Συρματόσχοινα	Σ. 286  Σωληνομαστοί	Σ. 83  Σωληνωτά κλειδιά	Σ. 132  Ταινίες αυτοκόλλητες	Σ. 263  Ταλουρίτ
Σ. 30  Ταμπακιέρες	Σ. 229  Τάπες περικογλιών	Σ. 231  Τάπες ποδιών	Σ. 75  Ταπόκλειδα	Σ. 79  Ταπόνια	Σ. 55  Ταφ	Σ. 130  Τζαμοκόφτες
Σ. 221  Τηλεσκοπικοί βραχίονες	Σ. 155  Τηλεσκοπικοί καθρέπτες	Σ. 155  Τηλεσκοπικοί μαγνήτες	Σ. 209  Τουμπόβουρτσες	Σ. 174  Τραβηχτήρια σύρματος	Σ. 274  Τροχαλίες	Σ. 110  Τρυπάνια δομικών υλικών
Σ. 114  Τρυπάνια μέταλλο	Σ. 118  Τρυπάνια ξύλου	Σ. 129  Τρυπανόβιδες	Σ. 186  Τρυπανοκολαούζα	Σ. 62  Τρυπητήρια δέρματος	Σ. 32  Τσάντες εργαλείων	Σ. 219  Τσεκούρια
Σ. 122  Τσέρκια	Σ. 211  Τσιμπίδες ηλεκτροκόλλησης	Σ. 78  Τσιμπίδες υδραυλικού	Σ. 193  Τσοκ δραπάνου	Σ. 219  Τσουβαλοδέτες	Σ. 159  Υγρό τεφλόν	Σ. 286  Υδραυλικά εξαρτήματα
Σ. 48  Φακοί	Σ. 133  Φαλτσέτες	Σ. 44  Φιάλες αερίου	Σ. 188  Φιλιέρες	Σ. 167  Φύλλερ	Σ. 132  Φίλμ χειρός	Σ. 183  Φλαντζοκόφτες
Σ. 24  Φλις εργασίας	Σ. 41  Φλόγιστρα	Σ. 21  Φόρμες εργασίας	Σ. 117  Φρεζάκια	Σ. 188  Φολιές	Σ. 44  Χαλκοκόλληση	Σ. 132  Χαρτοταινίες
Σ. 259  Χειρολαβές inox	Σ. 229  Χειρολαβές νάυλον	Σ. 125  Χημικά αγκύρια	Σ. 275  Χούφτες	Σ. 126  Χτυπητά βύσματα	Σ. 240  Χτυπητά βύσματα inox	Σ. 182  Χτυπητά γράμματα
Σ. 131  Χωνιά	Σ. 140  Ψαλίδια	Σ. 69  Ψαλίδια καλωδίων	Σ. 141  Ψαλίδια λαμαρίνας	Σ. 79  Ψαλίδια τουμποράματος	Σ. 275  Ωμέγα	Σ. 26  Ωτασπίδες



Αθλητικά παπούτσια γκρι



χωρίς ασφάλεια

Κωδικός	Μέγεθος
43740	40
43741	41
43742	42
43743	43
43744	44
43745	45
43746	46
43747	47



ENDURO

Kapriol

Αθλητικά παπούτσια ασφαλείας S3 μπλε



Κωδικός	Μέγεθος
41980	40
41981	41
41982	42
41983	43
41984	44
41985	45
41986	46
41987	47



DERBY BLUE

Kapriol

Αθλητικά παπούτσια ασφαλείας S3



Κωδικός	Μέγεθος
43600	40
43601	41
43602	42
43603	43
43604	44
43605	45
43606	46



WALKER

Kapriol

Αθλητικά παπούτσια μαύρο - πορτοκαλί



Εργασίας ανθεκτικά

Χωρίς ασφάλεια

Κωδικός	Μέγεθος
43951	41
43952	42
43953	43
43954	44
43955	45
43956	46
43957	47



DART 01

Kapriol

Μποτάκια εργασίας αδιάβροχα γκρι - πορτοκαλί



Χωρίς ασφάλεια

Κωδικός	Μέγεθος
43760	40
43761	41
43762	42
43763	43
43764	44
43765	45
43766	46
43767	47



ENDURO HIGH

Kapriol

Παπούτσια ασφαλείας S1P καφέ



SIOUX LOW

Κωδικός Μέγεθος

41031	41
41032	42
41033	43
41034	44
41035	45
41036	46

Kapriol

Μποτάκια ασφαλείας S3 καφέ



SIOUX HIGH

Κωδικός Μέγεθος

41040	40
41041	41
41042	42
41043	43
41044	44
41045	45
41046	46
41047	47

Kapriol

Μποτάκια ασφαλείας S3 καφέ



PATROL

Κωδικός Μέγεθος

43041	41
43042	42
43043	43
43044	44
43045	45
43046	46

Kapriol

Μποτάκια ασφαλείας S3 μαύρα



SPENCER

Κωδικός Μέγεθος

41970	40
41971	41
41972	42
41973	43
41974	44
41975	45
41976	46
41977	47

Kapriol

Μποτάκια εργασίας S3 μαύρα



KANSAS

Κωδικός Μέγεθος

43921	41
43922	42
43923	43
43924	44
43925	45
43926	46
43927	47

Kapriol

Πάτοι παπουτσιών

Gel μόνο στην φτέρνα
EVA GEL

Κωδικός	Μέγεθος
42125	39-40
42126	41-42
42127	43-44
42128	45-47



Kapriol'

Πάτοι παπουτσιών GEL

GEL

Κωδικός	Μέγεθος
42113	39-41
42114	42-44
42115	45-47



Kapriol'

Κάλτσες 60% βαμβάκι

Με απόσβεση κραδασμών

COMFORT

Κωδικός	Μέγεθος
32107	39-41 (M)
32108	42-44 (L)
32109	45-47 (XL)



Kapriol'

Κάλτσες 75% βαμβάκι

TUNDRA

Κωδικός	Μέγεθος
32092	39-41 (M)
32093	42-44 (L)
32094	45-47 (XL)



Kapriol'

Κάλτσες 75% βαμβάκι κοντές

**TUNDRA
LOW**

Κωδικός	Μέγεθος
32087	39-41 (M)
32088	42-44 (L)
32089	45-47 (XL)



Kapriol'

**Σπρέι
αδιαβρογοποίησης**

200ml



Κωδικός
42100

Kapriol'

Κορδόνια παπουτσιών



Κωδικός
42105

Kapriol'

Δερμάτινη ζώνη



Κωδικός
25013

Kapriol'

**Πολυεστερική ζώνη
μαύρη**

K-BELT



Κωδικός
25037

Kapriol'

Βερμούδα εργασίας μπεζ

KAVIR



Κωδικός	Μέγεθος
31592	XL
31593	XXL

Kapriol'

Βερμούδα εργασίας γκρι

97% βαμβάκι
3% ελαστάν



TENERE PRO

Κωδικός	Μέγεθος
32534	M
32535	L
32536	XL
32537	XXL

Kapriol'

Παντελόνι εργασίας γκρι

TENERE



Κωδικός Μέγεθος

31119	S
31120	M
31121	L
31122	XL
31123	XXL
31124	XXXL

Kapriol

Παντελόνι εργασίας μπέζ

NIGER



Κωδικός Μέγεθος

31049	S
31050	M
31051	L
31052	XL
31053	XXL

Kapriol

Παντελόνι εργασίας γκρι-μαύρο

NIGER



Κωδικός Μέγεθος

31055	S
31056	M
31057	L
31058	XL
31059	XXL
31060	XXXL

Kapriol

Παντελόνι εργασίας jeans

Teneré Pro Jeans

73% Βαμβάκι
25% Polyester
2% Elastane
310gr/m²



Κωδικός Μέγεθος

36040	S
36041	M
36042	L
36043	XL
36044	XXL
36045	XXXL

Kapriol

Παντελόνι εργασίας πράσινο **NEO**

Teneré Pro

97% Βαμβάκι
3% Elastane

270gr/m²

Προστατευτικές γκέτες



Κωδικός Μέγεθος

32387	S
32388	M
32389	L
32390	XL
32391	XXL
32392	XXXL

Kapriol

Παντελόνι εργασίας μαύρο με διπλές τσέπες

Slick black

35% Βαμβάκι
65% Polyester



Κωδικός Μέγεθος

36650	S
36651	M
36652	L
36653	XL
36654	XXL
36655	XXXL

Kapriol

Παντελόνι εργασίας γκρι-μαύρο

EXPERT



Κωδικός Μέγεθος

31812	XL
31813	XXL
31814	XXXL

Kapriol

Παντελόνι εργασίας γκρι-μαύρο

Καλοκαιρινό, ελαστικό



EXPERT LIGHT

Κωδικός Μέγεθος

31912	XL
-------	----

Kapriol



Παντελόνι εργασίας μπεζ-μπλε

Ελαστικό



**TENERE
PRO**

Κωδικός	Μέγεθος
32382	M
32383	L
32384	XL
32385	XXL

Καριολ'

Παντελόνι εργασίας γκρι-μαύρο

Ελαστικό



**TENERE
PRO**

Κωδικός	Μέγεθος
32375	S
32376	M
32377	L
32378	XL
32379	XXL
32380	XXXL

Καριολ'

Παντελόνι εργασίας μπλε

Ελαστικό



**TENERE
PRO**

Κωδικός	Μέγεθος
32393	S
32394	M
32395	L
32396	XL
32397	XXL
32398	XXXL

Καριολ'

Φόρμα εργασίας



BASIC

Κωδικός	Μέγεθος
80078	L
80079	XL
80080	XXL

Καριολ'

Σαλοπέτα εργασίας γκρι

INDUSTRY



Κωδικός	Μέγεθος
36401	M
36402	L
36403	XL
36404	XXL
36405	XXXL

Καριολ'

Σαλοπέτα εργασίας οικονομική

ESSENTIAL



Κωδικός	Μέγεθος
31935	M
31936	L
31937	XL
31938	XXL

Καριολ'

Μπουφάν αμάνικο μαύρο**TECH****Κωδικός Μέγεθος**

28886 M

28887 L

36931 XL

28888 XL

28889 XXL

28890 XXXL

Kapriol**Μπουφάν αμάνικο μπεζ****KAVIR****Κωδικός Μέγεθος**

31500 M

31501 L

Kapriol**Μπουφάν αμάνικο μαύρο****TEMPEST****Κωδικός Μέγεθος**

28670 M

28671 L

28672 XL

28673 XXL

28674 XXXL

Kapriol**Γιλέκο εργαλειοφόρος αμάνικο μαύρο**

Με διπλή σειρά τσέπες

SMART**Κωδικός Μέγεθος**

31716 L

31717 XL

31718 XXL

Kapriol**Μπουφάν αμάνικο γκρι****SMART****Κωδικός Μέγεθος**

32070 M

32071 L

32072 XL

32073 XXL

32074 XXXL

Kapriol

**Μπουφάν εργασίας****DRAGON**

Κωδικός	Μέγεθος
28808	XXL
28809	XXXL

Kapriol'**Μπουφάν εργασίας****SMART**

Κωδικός	Μέγεθος
32263	XL
32264	XXL

Kapriol'**Σετ αδιάβροχα παντελόνι - σακάκι**

Διαθέσιμα σε κίτρινο και πράσινο χρώμα

**RAIN**

Κωδικός	Μέγεθος
28180	XL
28181	XXL
28182	XL
28183	XXL

Kapriol'**T-shirts κόκκινα**"I'm here!
What should I fix?"

Κωδικός	Μέγεθος
36820	M
36821	L
36822	XL
36823	XXL
36824	XXXL

Kapriol'**T-shirts μπλε**

Κωδικός	Μέγεθος
36835	M
36836	L
36837	XL
36838	XXL
36839	XXXL

Kapriol'**T-shirts κόκκινα**"Everything in it's place
A place for everything"

Κωδικός	Μέγεθος
36840	M
36841	L
36842	XL
36843	XXL
36844	XXXL

Kapriol'

**Φλις εργασίας πολυεστερικό μαύρο****WOLF****Κωδικός Μέγεθος**

28381 M

28382 L

28383 XL

28384 XXL

28385 XXXL

Καριολ'**Φλις εργασίας πολυεστερικό ανθρακί****WOLF****Κωδικός Μέγεθος**

32300 M

32301 L

32302 XL

32303 XXL

32304 XXXL

Καριολ'**Σκουφάκι πλεκτό****FROZEN****Κωδικός**

31308

Καριολ'**Εσωθερμικό μπλουζάκι****TERMICA****Κωδικός Μέγεθος**

28790 M

28791 L

28792 XL

Καριολ'**Εσωθερμικό παντελόνι****TERMICA****Κωδικός Μέγεθος**

28785 M

28786 L

28787 XL

Καριολ'

Μάσκα προστασίας γκρι



RACING

Κωδικός
28173

Καριολ'

Μάσκα προστασίας διαφανής

Φοριέται και με γυαλιά οράσεως



SLALOM

Κωδικός
28116

Καριολ'

Γυαλιά προστασίας



COMBI

Κωδικός
28160

Καριολ'

Προστατευτικά γυαλιά



Κωδικός
G17

PLANO

Προστατευτικά γυαλιά



Κωδικός
G18

PLANO

Προστατευτικά γυαλιά



Κωδικός
G20

PLANO

Προστατευτικά γυαλιά



Κωδικός
G24

PLANO

Προστατευτικά γυαλιά με μεταλλικό σκελετό



Κωδικός
G42

PLANO

Προστατευτικά γυαλιά μαύρα



Κωδικός
G36

PLANO

**Ωτασπίδες εργασίας 27dB****SILVER 27****Κωδικός**
28103**Καριόλ'****Ωτασπίδες εργασίας 21dB****SILVER 21****Κωδικός**
28101**Καριόλ'****Ωτασπίδες εργασίας 24dB****SILVER 24****Κωδικός**
28102**Καριόλ'****Ωτασπίδες εργασίας 29dB****TEKNO
COMPACT****Κωδικός**
31252**Καριόλ'****Ωτασπίδες 36dB (5 ζεύγη)****CORD****Κωδικός**
28111**Καριόλ'**



Σύνδεσμος ασφαλείας 20kN



Κωδικός
27990

Καριολ'

Σύνδεσμος ασφαλείας 25kN



Κωδικός
27989

Καριολ'

Σύνδεσμος ασφαλείας 50kN



Κωδικός
27991

Καριολ'

Ζώνη ανάρτησης πτώσης



BASIC DUO

Κωδικός
27955

Καριολ'

Ζώνη ανάρτησης πτώσης



GAMMA 2

Κωδικός
27973

Καριολ'

Ζώνη θέσης



Κωδικός
27977

Καριολ'

Ιμάντας σύνδεσης 65 εκατοστών



Κωδικός
27994

Καριολ'

Ανασχετήρας ασφαλείας



Κωδικός
27978

Καριολ'

Διπλός αναδέτης σύνδεσης
Με απορρόφηση έντασης



Κωδικός
27953

Καριολ'

Κράνος ασφαλείας



Κωδικός
27999

Kapriol

Κράνη εργοταξίου



Κωδικός Χρώμα
28500 Κόκκινο
28501 Κίτρινο

Kapriol

Επιγονατίδες από PVC & σιλκόνη



Κωδικός
25251

Kapriol

Επιγονατίδες μαλακές

Polyester - E.V.A.



Κωδικός
KT100TB

PLANO

Επιγονατίδες

Polyester - E.V.A. - PVC



Κωδικός
KT300TB

PLANO

Επιγονατίδες με gel

Polyester - E.V.A. - PVC - AirGel®



Κωδικός
KT500TB

PLANO

Ένθετες επιγονατίδες



Κωδικός
25257

Kapriol



Γάντια νιτριλίου



THIN TOUCH

Κωδικός	Μέγεθος
28054	8
28055	9
28056	10
28043	11

Kapriol'

Γάντια νιτριλίου



DOTS

Κωδικός	Μέγεθος
28032	9
28033	10

Kapriol'

Γάντια νιτριλίου

Ανθεκτικά



BLADE

Κωδικός	Μέγεθος
28071	9
28072	10

Kapriol'

Γάντια νεοπρενίου



NEOPRENE

Κωδικός	Μέγεθος
28150	10

Kapriol'

Γάντια οδήγησης



DRIVER

Κωδικός	Μέγεθος
28144	10
28039	11

Kapriol'

Γάντια μεγάλης αντοχής

EN388:2016 4X44C



POWER CUT

Κωδικός	Μέγεθος
27714	9
27715	10

Kapriol'

Γάντια μεγάλης αντοχής

EN388:2016 2121X



CARPENTER

Κωδικός	Μέγεθος
28044	9
28045	10

Kapriol'

**Ταμπακιέρα 6 θέσεων**

Πολυπροπυλένιο



Κωδικός Διαστάσεις Βάρος
3449 16,5x12x2,5 0,09kg

**Ταμπακιέρα 6 θέσεων**Πολυπροπυλένιο
Ανταλλακτικό για τις εργαλειοθήκες
652 & 682

Κωδικός Διαστάσεις Βάρος
3452 18x12x3,5 0,14kg

**Ταμπακιέρα 4-19 θέσεων**

Πολυπροπυλένιο



Κωδικός Διαστάσεις Βάρος
3600 PRO 27,5x18x4 0,35kg

**Ταμπακιέρα 4-24 θέσεων**

Πολυπροπυλένιο



Κωδικός Διαστάσεις Βάρος
3700 PRO 35,5x23x5 0,52kg

**Ταμπακιέρα 8-30 θέσεων**

Πολυπροπυλένιο



Κωδικός Διαστάσεις Βάρος
4600 27x20x7 0,51kg

**Σετ 4 ταμπακιέρες με λαβή μεταφοράς**Πολυπροπυλένιο
4 x 3600 PRO

Κωδικός Διαστάσεις Βάρος
967 28x25x33 2,30kg

**Εργαλειοθήκη με 4 ταμπακιέρες**Πολυπροπυλένιο
περιορισμένη
διαθεσιμότητα

Κωδικός
1364

**Ταμπακιέρα πολυπροπυλενίου 21 θέσεων**

Κωδικός Τύπος
33567 310mm

**Θήκη υλικών**

ABS



Κωδικός Βάρος
ORGANIZER 1 2,10kg





Θήκη υλικών

ABS



Κωδικός Βάρος
SYSTEM 1 4,70kg



Εργαλειοθήκη 15"

Μεταλλικό μάνδαλο



Κωδικός Διαστάσεις Βάρος
351 39x21x19 1,00kg



Εργαλειοθήκη 16"

Μεταλλικό μάνδαλο
μαλακή λαβή



Κωδικός Διαστάσεις Βάρος
451 42x23x23 1,40kg



Εργαλειοθήκη 20"

Μεταλλικά μάνδαλα
μαλακή λαβή



Κωδικός Διαστάσεις Βάρος
652 51x28x29 2,30kg



Εργαλειοθήκη 26"

Μεταλλικά μάνδαλα
μαλακή λαβή



Κωδικός Διαστάσεις Βάρος
682 66x27x29 3,20kg



Εργαλειοθήκη 17"

Αναδιπλούμενο δίσκο



Κωδικός Διαστάσεις Βάρος
911 44x26x26 2,00kg



Θήκη μεταφοράς ηλεκτρικών εργαλείων 15"

Υποδοχή για εξαρτήματα



Κωδικός Διαστάσεις Βάρος
999 38x35x14,5 1,10kg



Εργαλειοθήκη συρταριέρα



Κωδικός Διαστάσεις Βάρος
873



Πολυεστερική τσάντα εργαλείων 12"



Κωδικός Διαστάσεις Βάρος
513000TB 31x19x24 0,70kg



Πολυεστερική τσάντα εργαλείων 16"



Κωδικός Διαστάσεις Βάρος
513002TB 41x24x26 1,20kg



Πολυεστερική τσάντα εργαλείων μπανάνα



Κωδικός
545TB



Πολυεστρερικό σακίδιο



Κωδικός Διαστάσεις
563TB 35x25x50



Πολυεστρερικό σακίδιο



Κωδικός
542TB



Πολυεστρερικό σακίδιο 19"



Κωδικός Διαστάσεις
513006NT 48x29x42



Πολυεστρερικό σακίδιο 17"



Κωδικός Διαστάσεις
513013 43x23x36



Πολυεστρερικό σακίδιο 11"

Τροχήλατο



Κωδικός Διαστάσεις
513014NR 46x26x36





Πολυεστερική τσάντα εργαλείων 15"



Κωδικός Διαστάσεις Βάρος
513011 38x23x30 1,90kg



Πολυεστερική τσάντα εργαλείων 17"



Κωδικός Διαστάσεις Βάρος
513012 42x23x27 1,70kg



Πολυεστερική βαλίτσα εργαλείων 19"



Κωδικός Διαστάσεις Βάρος
PC100E 48x40x17 3,60kg



Πολυεστερική βαλίτσα εργαλείων τρόλλευ 19"



Κωδικός Διαστάσεις Βάρος
PC120E 48x46x24 5,20kg



Πολυεστερική βαλίτσα εργαλείων 19"



Κωδικός Διαστάσεις
513008NT 48x32x29



Βαλίτσα εργαλείων



Κωδικός
559TB



Πολυεστερική σκληρή τσάντα εργαλείων 20"



Κωδικός Διαστάσεις Βάρος
PC513004 50x25x29 2,40kg



Βαλίτσα εργαλείων 21"

ABS



Κωδικός	Διαστάσεις	Βάρος
PC600E	53x42x20	5,70kg

**Βαλίτσα εργαλείων 21" με ρόδες**

ABS



Κωδικός	Διαστάσεις	Βάρος
PC620E	53x42x26	7,20kg

**Βαλίτσα αδιάβροχη IP67 21"**

ABS



Κωδικός	Διαστάσεις	Βάρος
PC700E	52,5X22X17cm	5,4kg

**Βαλίτσα αδιάβροχη IP67 21"**

ABS



Κωδικός	Διαστάσεις	Βάρος
PC800	52,5X22X40cm	5,9kg

**Βαλίτσα εργαλείων 20,6" με ρόδες**

ABS



Κωδικός	Διαστάσεις	Βάρος
PC720E	52,5x40x22	7,60kg

**Βαλίτσα εργαλείων 20,6" με ρόδες**

ABS



Κωδικός	Διαστάσεις	Βάρος
PC820E	52,5x40x27	8,10kg

**Μπαούλα**Πολυπροπυλένιο
-45°~60°C

Κωδικός	Διαστάσεις	ΠΒΥ	Χωρητικότητα	Βάρος
HDP60	60x48x48cm		60ℓ	5,9kg
HDP80	80x48x50cm		113ℓ	8,3kg
HDP100	100x48x50cm		160ℓ	10kg

**Πολυεστρερικό γιλέκο εργαλείων**Κωδικός
513010



**Πολυεστερική θήκη εργαλείων που τυλίγεται
Κρεμίζεται**



Κωδικός Βάρος
558NR 1,10kg



Πολυεστερική εργαλειοθήκη ώμου



Κωδικός
546TX



Πολυεστερική εργαλειοθήκη ώμου



Κωδικός
550NT



Πολυεστερική εργαλειοθήκη ώμου



Κωδικός
556TB



**Πολυεστερική εργαλειοθήκη μέσης
με ζώνη μεγάλης αντοχής**



Κωδικός
52200TB



Πολυεστερική θήκη ζώνης για εργαλεία



Κωδικός
533TB



Πολυεστερική θήκη ζώνης για εργαλεία



Κωδικός
534TB



Πολυεστερική θήκη ώμου για εργαλεία



Κωδικός
543TB



**Πολυεστερική θήκη ζώνης για βιδολόγο****Κωδικός**
531TB**Πολυεστερική θήκη ζώνης για εργαλεία με κλιπ για τη ζώνη****Κωδικός**
522TB**Πολυεστερική θήκη εργαλείων****Κωδικός**
524**Πολυεστερική ζώνη με κλιπ**ενισχυμένη
για μέση:
90~120cm**Κωδικός**
530TB**Θήκη κινητού****Κωδικός**
549TB**Θήκη κινητού**Poliestere
για μεγαλύτερα μοντέλα**Κωδικός**
539TB**Θήκη ζώνης για σφυρί**

Poliestere

**Κωδικός**
526TX**Θήκη κινητού τύπου Galaxy**

Poliestere - E.V.A.

**Κωδικός**
549XLTB**Θήκη για tablet****Κωδικός**
562TB



513010



550NT



556TB



52200TB



530TB



522TB



531TB



533TB



534TB



543TB



549TB



549XLTB



539TB



562TB

Θήκες ζώνης για εργαλεία

Μεταλλικές



Κωδικός	Τύπος
25016	Μικρή
25015	Μεγάλη

Kapriol**Μπανάνα μέσης**

Κωδικός
25032

Kapriol**Μπανάνα μέσης**

Κωδικός
25042

Kapriol**Στιβαζόμενη εργαλειοθήκη**

Υλικό: Πολυπροπυλένιο

Με 6 αποσπώμενα κουτάκια με καπάκι



Κωδικός	Τύπος
320360	528x371x179mm

TACTIX**Στιβαζόμενη εργαλειοθήκη**

Υλικό: Πολυπροπυλένιο

Με 2 αποσπώμενα διαχωριστικά



Κωδικός	Τύπος
320361	528x371x310mm

TACTIX**Στιβαζόμενη εργαλειοθήκη**

Υλικό: Πολυπροπυλένιο

Με 6 αποσπώμενα διαχωριστικά σε κάθε συρτάρι



Κωδικός	Τύπος
320362	528x371x399mm

TACTIX**Καρότσι μεταφοράς**

Φορτίο έως 100 κιλά



Κωδικός	Τύπος
320364	615x460x1000mm

TACTIX**Μεταλλικές εργαλειοθήκες**

Λαμαρίνα πάχους 0,6mm

Υποδοχή για λουκέτο



Κωδικός	Τύπος
FG 111/A	3 θέσεων 430x160x200mm
FG 111/B	5 θέσεων 430x200x200mm
FG 111/C	5 θέσεων 530x160x200mm

FASANO**Μεταλλικός εργαλειοφόρος τροχήλατος**5 ρηγά συρτάρια
2 βαθιά συρτάρια
Κλειδώνει

Κωδικός	Τύπος
05.088.55	980X760X465mm

SPIN

Σολντερίνη



Κωδικός	Βάρος
415005	50gr
415010	100gr



Καλάι



Κωδικός	Τύπος
30-400010-0	1,0mm 100gr 60/40
30-391010-0	1,0mm 100gr 70/30
30-400025-0	1,0mm 250gr 60/40
30-391025-0	1,0mm 250gr 70/30
30-401025-0	1,5mm 250gr 60/40
30-392025-0	1,5mm 250gr 70/30
30-402025-0	2,0mm 250gr 60/40
30-393025-0	2,0mm 250gr 70/30



Κολλητήρι μπαταρίας

Λειτουργεί με μπαταρίες AA (δεν περιλαμβάνονται)



Κωδικός
1620



Κολλητήρι μπαταρίας επαναφορτιζόμενο

Λειτουργεί με μπαταρία λιθίου 3,6V 2200mAh



Κωδικός
1622



Κολλητήρια 230V



Κωδικός	Ισχύς
370003	30W



Κολλητήρια 230V

Περιέχονται 2 μύτες



Κωδικός	Ισχύς
170040	30W
170060	40W
170080	60W
170100	100W



Κολλητήρια 230V επαγγελματικά

Περιέχονται 2 μύτες



Κωδικός	Ισχύς
3020CD	50W
3025CD	100W



Κολλητήρι πιστόλι 200W

Περιέχει 3 μύτες



Κωδικός
1740 PRO



Εργαλείο φελιζόλ 9W

Κόβει - Σκαλίζει



Κωδικός
1650



Κολλητήρια με χαβιά



Κωδικός Ισχύς
3030N 120W
3040N 250W
3050N 320W



Κολλητήρια με χαβιά



Κωδικός	Ισχύς
30-376040-0	400W
30-382750-0	Μύτη 500W
30-378540-0	Αντίσταση 400W
30-378550-0	Αντίσταση 500W



Κολλητήρι αερίου με χαβιά



Κωδικός
600000



Ανταλλακτική μύτη χαβιά αερίου

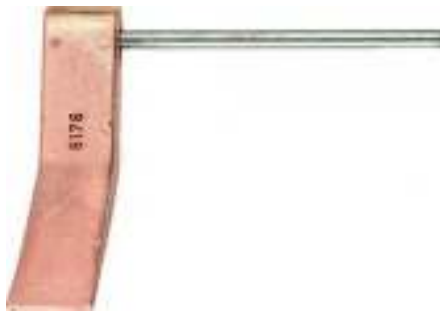

Κωδικός
6176200



Ανταλλακτικές μύτες πυρογράφου

6 μύτες



Κωδικός
1510



Ανταλλακτικές στάμπες πυρογράφου

7 στάμπες



Κωδικός
1505



Ανταλλακτικές λεπίδες πυρογράφου

6 λεπίδες



Κωδικός
1515





Αντίσταση εργαλείου φελιζόλ

Μήκος: 1 μέτρο. Πάχος 0,23 χιλιοστά.



Κωδικός

1651



Σετ 5 μύτες και προσαρμογέας

Για το φλόγιστρο στυλό 10500



Κωδικός

10503



Σετ 3 ακροφύσια

Για το φλόγιστρο στυλό 10500



Κωδικός

10521



Κολλητήρι αερίου 3 σε 1

Φλόγιστρο - Κολλητήρι - Πυρογράφος



Κωδικός

12100 KIT



Κολλητήρι αερίου φλόγιστρο



Κωδικός

12000 KIT



Σετ 5 εξαρτήματα

Για το φλόγιστρο βουτανίου 12000 KIT



Κωδικός

12101



Σετ εξαρτήματα

Για το φλόγιστρο βουτανίου 12500



Κωδικός

12501



Μίνι φλόγιστρο βουτανίου

Λειτουργεί με αέριο αναπτήρων.
Στέκεται όρθιος



Κωδικός
1048D

**Φλόγιστρο βουτανίου**

Λειτουργεί με αέριο αναπτήρων



Κωδικός
12500

**Φλόγιστρο ζαχαροπλαστικής**

Διακόπτης ασφαλείας - Δυνατότητα
συνεχούς λειτουργίας



Κωδικός
13000

**Φλόγιστρα υγραερίου πλαστικό**

Κωδικός Τύπος
KE2018 Απλό μπλε
KE2019 Πιεζοηλεκτρικό

**Φλόγιστρο υγραερίου πλαστικό**

Κωδικός Τύπος
505000 Απλό

**Φλόγιστρο με 3 ακροφύσια Ø14 Ø18 Ø22**

Κωδικός
601050

**Φλόγιστρο με 3 ακροφύσια Ø20 Ø30 Ø45**

Κωδικός
1217 KIT

**Φλόγιστρο χειρός μακρύ με πάσο 7/16"**

Με πιεζοηλεκτρική ανάφλεξη και φιάλη αερίου.
Για κάψιμο χόρτων σε δύσκολα σημεία,
γρήγορο άναμμα τζακιού, bbq κλπ.



Κωδικός
1047GBPC

**Φλόγιστρα μακριά**

Ρυθμιζόμενα με σκανδάλη



Κωδικός Τύπος
121945M Ø45mm 63cm
121960L Ø60mm 86cm





Φλόγιστρο προπανίου - βουτανίου



Κωδικός
572592



Αντάπτορας από CGA600 σε 7/16"

Για σύνδεση φλόγιστρων τύπου MAPP-PRO σε φιάλες αερίου με πάσο 7/16"



Κωδικός
490280



Αντάπτορας ΑΡΣ 7/16" ΘΗΛ CGA600



Κωδικός
583



Αντάπτορας ΘΗΛ 7/16" ΑΡΣ CGA600



Κωδικός
584



Αντάπτορας M10X1 σε M12X1



Κωδικός
588B



Αντάπτορας M12X1 σε M10X1



Κωδικός
589B



Φορητή οξυγονοκόλληση Set200

Με φιάλη οξυγόνου και φιάλη προπανίου MAPP GAS
 $\leq 3100^{\circ}\text{C}$



Κωδικός
111010

**Φιάλη MAPP GAS 400 γραμμαρίων**

Πάσο CGA600



Κωδικός
SEH024600

**Φιάλη προπανίου-βουτανίου**

330γρ.
 Πάσο $7/16''$
 αρσ.



Κωδικός
483150

**Φιάλη προπανίου-βουτανίου**

SUPERGAS
 600ml
 Πάσο $7/16''$
 αρσ.



Κωδικός
575

**Φιάλη προπανίου**

350γρ MAXI GAS
 Πάσο $7/16''$
 αρσ.



Κωδικός
483200

**Μπρουντζοκόλληση σε ράβδους**

10 τεμάχια



Κωδικός
101500

**Χαλκοκόλληση σε ράβδους**

10 τεμάχια



Κωδικός
101510

**Μολυβδοκόλληση σε ράβδους**

2 τεμάχια



Κωδικός
101590



Λάμπα οξυγόνου - προπανίου

Για το Set90. Πάσο M12X1 δεξιόστροφο



Κωδικός
110000



Μειωτήρες με μανόμετρα

Κωδικός	Τύπος
260253	Οξυγόνου
260550	Οξυγόνου Power control
261250	Ασετυλίνης
265500	Argon
262350	Προπανίου
264250	Αζώτου



Παγίδα φλόγας για σωλήνες οξυγόνου



Κωδικός
150210



Παγίδα φλόγας για σωλήνες αερίου



Κωδικός
150190



Μειωτήρας προπανίου με μανόμετρο



Κωδικός
282500



Ρυθμιστής οξυγόνου 7/16"



Κωδικός
260553



Ρυθμιστής αερίου για το Set90



Κωδικός
201500



Ρυθμιστής οξυγόνου M12X1 δεξιόστροφος



Κωδικός
220500

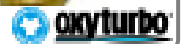

**Γκαζάκι υγραερίου****Κωδικός**
KE2009**Φιάλη βουτανίου 150ml****Κωδικός**
10051**Αναπτήρες BBQ**

Κόκκινο Μπλε Πορτοκαλί Γκρι

**Κωδικός**
1049D**Αναπτήρες BBQ σπαστοί**

Κόκκινο Μπλε Κίτρινο Μαύρο

**Κωδικός**
1049DF**Πλεκτά σχοινιά**

Κωδικός	Πάχος
EVI-03	3mm
EVI-04	4mm
EVI-05	5mm
EVI-06	6mm
EVI-08	8mm
EVI-10	10mm
EVI-12	12mm
EVI-14	14mm
EVI-16	16mm
EVI-18	18mm
EVI-20	20mm

**Σχοινιά μαύρα**

Κωδικός	Πάχος
EVI-M03	3mm
EVI-M04	4mm
EVI-M05	5mm
EVI-M06	6mm
EVI-M08	8mm
EVI-M10	10mm

**Καννάβινα σχοινιά**

Κωδικός	Πάχος
EV-K06	6mm
EV-K08	8mm
EV-K10	10mm
EV-K12	12mm
EV-K14	14mm
EV-K16	16mm
EV-K20	20mm
EV-K22	22mm

**Ελαστικά σχοινιά**

Έγχρωμα	
Κωδικός	Πάχος
EV-L04C	4mm
EV-L05C	5mm
EV-L06C	6mm
EV-L08C	8mm
EV-L10C	10mm
Μαύρα	
Κωδικός	Πάχος
EVI-L04	4mm
EVI-L05	5mm
EVI-L06	6mm
EVI-L08	8mm
EVI-L10	10mm





Ιμάντας πρόσδεσης



Κωδικός **Τύπος**
LC750KG 25mmX4,5m 750kg

Ιμάντες πρόσδεσης φορτίων



Κωδικός **Διαστάσεις** **Φορτίο**
RLS03060 38mmX6 μέτρα 3 τόνοι

TAIWAN

Ιμάντες πρόσδεσης φορτίων



με μονό γάντζο

Κωδικός **Διαστάσεις** **Φορτίο**
509500 50mmX9 μέτρα 5 τόνοι

TAIWAN

Ιμάντες πρόσδεσης φορτίων



με διπλό γάντζο

Κωδικός **Διαστάσεις** **Φορτίο**
509501 50mmX9 μέτρα 5 τόνοι

TAIWAN

Ιμάντες ανύψωσης φορτίων 50X3,8mm

Φορτίο: ≤800 κιλά BS50380010-BS5038100

Μήκος	Μήκος
3m	6m
3,5m	7m
4m	8m
4,5m	9m
5m	10m



TAIWAN

Ιμάντες ανύψωσης φορτίων 50X7,6mm

Φορτίο: ≤2 τόνοι BD50760010-BD5076100

Μήκος	Μήκος
1m	4,5m
1,5m	5m
2m	6m
2,5m	7m
3m	8m
3,5m	9m
4m	10m



TAIWAN



Φακός πολυεργαλείο



Κωδικός
IN252



Φακός τηλεσκοπικός με 3 led



Κωδικός
IF05.012E



Φακός στυλό με 8 led

Με γάντζο και μαγνήτη



Κωδικός
DL401.012E



Σετ ξυλογλυπτικής



Κωδικός **Τύπος**
1285-001 5 τεμαχίων



Σετ ξυλογλυπτικής



Κωδικός **Τύπος**
1278-006 6 τεμαχίων



Σκαρπέλα Ιαπωνίας

Ανθρακούχο ατσάλι
Μεγάλη αντίσταση σε κρούσεις



Κωδικός **Τύπος**
EN-015BP 9mm
EN-02BP 12mm
EN-025BP 15mm
EN-03BP 19mm
EN-035BP 22mm



Μαχαίρια κουζίνας

Τύπου Δαμασκού



Κωδικός **Τύπος**
9232-135 135mm
9232-160 160mm
9232-180 180mm





Ακονόπετρα

K-40



Κωδικός **Τύπος**
3838-002 Grit 250/1000

TopMan

Ιαπωνική ακονόπετρα νερού

176x52x15mm



Κωδικός **Τύπος**
3839-005 Grit 4000

TopMan

Ιαπωνική ακονόπετρα νερού

210x73x22mm



Κωδικός **Τύπος**
3854-011 Grit 8000

TopMan

Ιαπωνική ακονόπετρα νερού



Κωδικός **Τύπος**
3853-100 Grit 1000

TopMan

Ιαπωνική ακονόπετρα νερού



Κωδικός **Τύπος**
3854-002 Grit 6000

TopMan

Ιαπωνική ακονόπετρα νερού



Κωδικός **Τύπος**
K-PB-04
3853-304 Grit 800/6000

TopMan

Κατσαβίδια Z ίσια



Κωδικός	Τύπος
22-177010-0	4X100mm
22-177012-0	5,5X140mm



Κατσαβίδια Z PH1 & PH2



Κωδικός
22-178010-0



Δοκιμαστικό κατσαβίδι

3X65mm



Κωδικός
240902001



Κατσαβίδια Wittron ίσια



Κωδικός	Τύπος
89712	1X40mm
89714	1,5X40mm
89716	2X60mm
89717	2,5X75mm



Κατσαβίδια Wittron Phillips



Κωδικός	Τύπος
89731	PH000X40mm
89732	PH00X40mm
89733	PH0X60mm
89734	PH1X80mm



Κατσαβίδια Wittron Torx



Κωδικός	Τύπος
89751	T5X50mm
89752	T6X50mm
89753	T7X50mm
89754	T8X60mm



Σετ κατσαβίδι ηλεκτρονικών

Σε πορτοφόλι

0,25x1,5 - 0,5x3
0,4x2 - 0,6x3,5
0,4x2,5 - 0,8x4

#000 - #00
#0 - #1

Κωδικός	Τύπος
99-0106	1/8"



Σετ 8 μίνι κατσαβιδιών χρυσοχόου

Ίσια: 2-2,5-3-3,5-4mm
PH00-PH0-PH1
Μήκος άξονα 75mm



Κωδικός	Τύπος
2087A	233mm



Σετ κατσαβίδια ηλεκτρονικών Torx με τρύπα

Κασετίνα

T-5H, T-6H, T-7H,
T-8H 40mm

T-9H, T-10H, T-15H,
T-20H 75mm



Κωδικός
2088AT



**Κατσαβίδια χούφτας ίσια**

Μήκος άξονα: 25mm



Κωδικός	Τύπος
713055S	1X5,5mm
713065S	1,2X6,5mm

FORCE**Κατσαβίδια ίσια**

Κωδικός	Τύπος	Κωδικός	Τύπος
87301	3,5X75mm	87307	6,5X125mm
87303	4X75mm	87309	8X150mm
87304	4X100mm	87310	8X175mm
87305	5,5X100mm		
87306	5,5X125mm		

WITTE**Κατσαβίδι ίσιο μακρύ**

4X300mm



Κωδικός
86894

WITTE**Κατσαβίδια ίσια INOX**

Κωδικός	Τύπος	Κωδικός	Τύπος
73021	3X75mm	73025	6,5X150mm
73023	4X100mm		
73024	5,5X125mm		

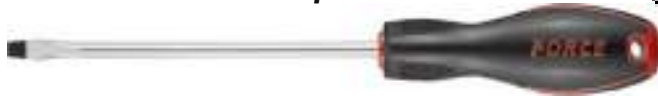
WITTE**Κατσαβίδια ίσια**

Κωδικός	Τύπος	Κωδικός	Τύπος
71303	0,5X3mm	713055	1X5,5mm
713035	0,5X3,5mm	713065	1,2X6,5mm
71304	0,8X4mm		

FORCE**Κατσαβίδια ίσια**

Με εξάγωνο για υποβοήθηση

Κωδικός	Τύπος
71308	1,2X8mm

FORCE**Κατσαβίδια ίσια Maxx Line**

Κωδικός	Τύπος
531012016	0,6X3,5X75mm
531052016	1,0X5,5X100mm
531072016	1,2X6,5X125mm
531092016	1,2X8,0X150mm
531102016	1,6X8,0X175mm

WITTE**Κατσαβίδια ίσια μακριά 300mm**

Κωδικός	Τύπος
655304	4mm
655305	5mm

FORCE**Κατσαβίδι ίσιο 1000V**

VDE



Κωδικός	Τύπος
982035SL	3,5X0,6mm

KNIPLEX**Κατσαβίδια ίσια 1000V**

VDE Maxpro



Κωδικός	Τύπος	Κωδικός	Τύπος
53702	3X100mm	53705	5,5X125mm
74054	4X100mm	53706	6,5X150mm
53704	4X100mm		

WITTE**Σταυροκατσαβίδια Phillips Modul 1000V**

Κωδικός	Τύπος	Τύπος
74082	PH1X80mm	PRO VDE
53741	PH1X80mm	VDE Maxpro
53742	PH2X100mm	VDE Maxpro

WITTE**Κατσαβίδι Pozidrive 1000V**

PRO VDE



Κωδικός	Τύπος
74073	PZ2X100

WITTE

Σταυροκατσάβιδα χούφτας Phillips

Μήκος άξονα: 25mm

**Κωδικός** **Τύπος**

7111S PH1

7112S PH2

FORCE**Σταυροκατσάβιδα Phillips****Κωδικός** **Τύπος**

94901 PH0X60mm

94902 PH1X80mm

94904 PH2X100mm

94906 PH3X150mm

WITTE**Σταυροκατσάβιδα Phillips Maxx Line****Κωδικός** **Τύπος**

530352016 PH2X100mm

530372016 PH2X300mm

WITTE**Σταυροκατσάβιδα Phillips μακριά****Κωδικός** **Τύπος**

94903 PH1X300mm

94905 PH2X300mm

WITTE**Σταυροκατσάβιδα Phillips INOX****Κωδικός** **Τύπος**

73032 PH1X80mm

73035 PH2X100mm

73038 PH3X150mm

WITTE**Κατσαβίδα Phillips μακριά 350mm****Κωδικός** **Τύπος**

65511 PH1

65512 PH2

FORCE**Σταυροκατσάβιδα Phillips****Κωδικός** **Τύπος** **Κορμός**

7110 PH0 60mm

7111 PH1 80mm

7112 PH2 100mm

7113 PH3 150mm

FORCE**Σταυροκατσάβιδα Phillips 1000V**

VDE Maxpro

**Κωδικός** **Τύπος**

53710 PH0X60mm

53711 PH1X80mm

WITTE**Σταυροκατσάβιδα Pozidrive****Κωδικός** **Τύπος**

99702 PZ1X80mm

99704 PZ2X100mm

99706 PZ3X150mm

WITTE**Σταυροκατσάβιδα Pozidrive**

Με εξάγωνο

**Κωδικός** **Τύπος**

99901 PZ1X80mm

99902 PZ2X100mm

WITTE**Σταυροκατσάβιδα Posidrive INOX****Κωδικός** **Τύπος**

73042 PZ1X80mm

73045 PZ2X100mm

73048 PZ3X150mm

WITTE**Σταυροκατσάβιδα Pozidrive****Κωδικός** **Τύπος** **Κορμός**

7121 PZ1 80mm

7122 PZ2 100mm

7123 PZ3 150mm

FORCE

Κατσαβίδια allen μπίλιας



Κωδικός	Τύπος	Κωδικός	Μέγεθος
350-0150	1,5mm	350-0500	5mm
350-0200	2mm	350-0600	6mm
350-0250	2,5mm	350-0800	8mm
350-0300	3mm	350-1000	10mm
350-0400	4mm		

ARNDT

Κατσαβίδια allen μπίλιας



Κωδικός	Μέγεθος	Κωδικός	Μέγεθος
71502	2mm	71505	5mm
715025	2,5mm	71506	6mm
71503	3mm	71508	8mm
71504	4mm		

FORCE

Κατσαβίδια Torx

Protop



Κωδικός	Τύπος	Κωδικός	Τύπος
99004	T8X60	99009	T25X100
99005	T9X60	99010	T27X115
99006	T10X80	99011	T30X115
99007	T15X80	99012	T40X115
99008	T20X100		

WITTE

Κατσαβίδια Torx INOX



Κωδικός	Τύπος	Κωδικός	Τύπος
73206	T10X80mm	73211	T30X115mm
73207	T15X80mm	73212	T40X115mm
73208	T20X100mm		
73209	T25X100mm		

WITTE

Κατσαβίδια Torx μακριά



Κωδικός	Τύπος	Κορμός	Μήκος
71630010	T10	300mm	405mm
71630015	T15	300mm	405mm
71630020	T20	300mm	405mm
71630025	T25	300mm	405mm
71630027	T27	300mm	415mm
71630030	T30	300mm	415mm

FORCE

Κατσαβίδια Torx με τρύπα



Κωδικός	Τύπος	Κορμός	Κωδικός	Τύπος	Κορμός
71705	TT5	60mm	71720	TT20	100mm
71706	TT6	60mm	71725	TT25	100mm
71707	TT7	60mm	71727	TT27	115mm
71708	TT8	60mm	71730	TT30	115mm
71709	TT9	60mm	71740	TT40	130mm
71710	TT10	80mm	71745	TT45	130mm
71715	TT15	80mm			

FORCE

Κατσαβίδια Torx



Κωδικός	Τύπος	Κωδικός	Τύπος
640-0005	T5	640-0009	T9
640-0006	T6	640-0010	T10
640-0007	T7	640-0015	T15
640-0008	T8		

ARNDT

Κατσαβίδια Tri-wing



Κωδικός	Τύπος
53072	3X100mm

WITTE

Κατσαβίδια τετράγωνα



Κωδικός	Τύπος
S119-1-1001	SQ1x100
S119-1-1252	SQ2x125
S119-1-1503	SQ3x150

whirlpower

Κατσαβίδια καρυδάκια

Κωδικός	Τύπος
99505	5,5X100mm
99506	6X125mm
99507	7X125mm
99508	8X125mm
99510	10X125mm
99511	11X125mm
99512	12X125mm
99513	13X125mm

**Κατσαβίδια καρυδάκια**

Κωδικός	Τύπος	Κωδικός	Τύπος
74425004	4mm	74425009	9mm
744250045	4,5mm	74425010	10mm
74425005	5mm	74425011	11mm
744250055	5,5mm	74425012	12mm
74425006	6mm	74425013	13mm
74425007	7mm	74425014	14mm
74425008	8mm		

**Κατσαβιδολαβή για καρυδάκια 1/4" εύκαμπτη**

Κωδικός	Μήκος
6481.4	160mm
8113	275mm

**Κατσαβίδια καρυδάκια με εύκαμπτο σπирάλ μήκος 270 χιλιοστά**

Κωδικός	Τύπος
64806	6mm
64807	7mm
64808	8mm

**Κατσαβίδι καρυδάκι με εύκαμπτο σπирάλ μήκος 270 χιλιοστά**

Κωδικός	Τύπος
6480607	6mm - 7mm

**Κατσαβίδι για μύτες 1/4"**

Κωδικός	Τύπος
8144	

**Σειρά κατσαβιδιών**

Maxpro
 PH1X80
 PH2X100
 4X75
 5,5X100
 6,5X125



Κωδικός
670069

**Σειρά 6 κατσαβιδιών 1000V**

PRO VDE
 PH1X80
 PH2X100
 3X100
 4X100
 5,5X125
 6,5X150



Κωδικός
670027200





Allen με πλαστική λαβή

WITTE
Manufacturing

Κωδικός	Τύπος
81102	2X100
81125	2,5X100
81103	3X150
81104	4X150
81105	5X200
81106	6X200
81108	8X200

Ταφ Torx με πλαστική λαβή

WITTE
Manufacturing

Κωδικός	Τύπος
81409	T9X100
81410	T10X100
81415	T15X100
81420	T20X100
81425	T25X110
81427	T27X110
81430	T30X130
81440	T40X130

Ταφ Allen



FORCE

Κωδικός	Τύπος
76402T	2mm
764025T	2,5mm
76403T	3mm
764035T	3,5mm
76404T	4mm
764045T	4,5mm
76405T	5mm
76406T	6mm
76407T	7mm
76408T	8mm

Κλειδιά ταφ allen μπίλιας



Με πλαστική λαβή



FORCE

Κωδικός	Τύπος
76502G	2mm
765025G	2,5mm
76503G	3mm
76504G	4mm
76505G	5mm
76506G	6mm
76508G	8mm

Κλειδιά ταφ torx



Με πλαστική λαβή



FORCE

Κωδικός	Τύπος
76710G	T10
76715G	T15
76720G	T20
76725G	T25
76727G	T27
76730G	T30
76740G	T40

Ταφ σταθερά καρδάκια



FORCE

Κωδικός	Τύπος
77407B	7mm
77408B	8mm
77410B	10mm
77412B	12mm
77413B	13mm

Ταφ σπαστά καρδάκια



FORCE

Κωδικός	Τύπος	Κωδικός	Τύπος
784206U	6mm	784315U	15mm
784207U	7mm	784316U	16mm
784208U	8mm	784317U	17mm
784209U	9mm	784418U	18mm
784310U	10mm	784419U	19mm
784311U	11mm	784420U	20mm
784312U	12mm	784421U	21mm
784313U	13mm	784422U	22mm
784314U	14mm	784424U	24mm

Καρδάκια Ταφ

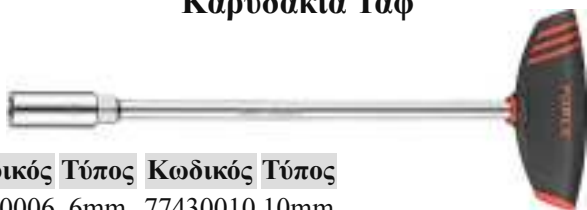

FORCE

Κωδικός	Τύπος	Κωδικός	Τύπος
77430006	6mm	77430010	10mm
77430007	7mm	77430011	11mm
77430008	8mm	77430012	12mm
77430009	9mm	77430013	13mm

Μαρκαδόροι ανεξίτηλοι

MARKER PEN

Πορτοκαλί, Ασημί,
Γαλάζιο, Λευκό,
Μπλε, Κίτρινο,
Μαύρο, Χρυσό,
Ροζ, Κόκκινο,
Πράσινο, Μωβ



Κωδικός
66610/MIX



Σημαδευτήρι γωνιακό



Κωδικός Τύπος
47051 na

ARNDT

Σημαδευτήρι ίσιο



Κωδικός Τύπος
25-177515-0 150mm



Κατσαβίδι προκοβγάλης



Κωδικός Τύπος
2366

ARNDT

Εργαλείο εξαγωγής κλίπ αυτοκινήτων

Δίχαλο



Κωδικός Τύπος
905M2P2 4mm
905M2P1 6mm

FORCE

Σετ εργαλείων ανοίγματος καλυμμάτων αυτοκινήτου



Κωδικός Τύπος
905M1 5 τεμάχια

FORCE

Σετ άγκιστρα



Κωδικός Τύπος
904U4

FORCE

Σουβλί 6X100



Κωδικός Τύπος
92500

WITTE

Μύτες Phillips 25mm



Κωδικός	Τύπος
27020	PH1X25
27021	PH2X25
27022	PH3X25



Μύτες Pozidrive 25mm



Κωδικός	Τύπος
27045	PZ1X25
27046	PZ2X25
27047	PZ3X25



Μύτες Τετράγωνα 25mm



Κωδικός	Τύπος
27091	SQ1X25
27092	SQ2X25
27093	SQ3X25



Μύτες Phillips 25mm INOX



Κωδικός	Τύπος
427711	PH1X25
427712	PH2X25
427713	PH3X25



Μύτες Pozidrive 25mm INOX



Κωδικός	Τύπος
427721	PZ1X25
427722	PZ2X25
427723	PZ3X25



Μύτες τιτανίου Phillips με λαιμό



Κωδικός	Τύπος
492701	PH1X25
492702	PH2X25
492703	PH3X25



Μύτες τιτανίου Pozidrive με λαιμό

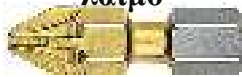

Κωδικός	Τύπος
492704	PZ1X25
492705	PZ2X25
492706	PZ3X25



Μύτες Phillips 50mm



Κωδικός	Τύπος
27520	PH1X50
27521	PH2X50
27522	PH3X50



Μύτες Pozidrive 50mm

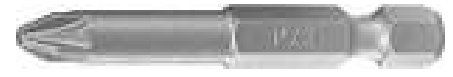

Κωδικός	Τύπος
27545	PZ1X50
27546	PZ2X50
27547	PZ3X25



Μύτες Phillips Τιτανίου 50mm



Κωδικός	Τύπος
492752	PH1X50
492753	PH2X50
492754	PH3X50



Μύτες Phillips πολύ μακριές



Κωδικός	Τύπος
27450	PH1X70
27451	PH1X90
27455	PH2X70
27456	PH2X90
27459	PH2X150
27460	PH3X70
27461	PH3X90



Μύτες Pozidrive πολύ μακριές



Κωδικός	Τύπος
27560	PZ1X70
27565	PZ2X70
27570	PZ3X70
27561	PZ1X90
27566	PZ2X90
27571	PZ3X90



Μύτες Pozidrive Τιτανίου 50mm



Κωδικός	Τύπος
492755	PZ1X50
492756	PZ2X50
492757	PZ3X50



Μύτες Τετράγωνα 50mm



Κωδικός	Τύπος
27591	SQ1X50
27592	SQ2X50
27593	SQ3X50



Μύτες Torx πολύ μακριές



Κωδικός	Τύπος
29676	T30X70
29677	T40X70
29686	T30X90
29687	T40X90



Μύτες Torx 25mm

DIN3126



Κωδικός	Τύπος	Κωδικός	Τύπος
29459	T4X25	429504	T15X25
29460	T5X25	429505	T20X25
27490	T6X25	429506	T25X25
27495	T7X25	429507	T27X25
429501	T8X25	429508	T30X25
429502	T9X25	429509	T40X25
429503	T10X25		

Μύτες Torx 25mm INOX



Κωδικός	Τύπος
427730	T10X25
427731	T15X25
427732	T20X25
427733	T25X25
427734	T27X25
427735	T30X25
427736	T40X25

Μύτες Torx 50mm



Κωδικός	Τύπος
429603	T10X50
429604	T15X50
429605	T20X50
429606	T25X50
429607	T27X50
429608	T30X50
429609	T40X50

Μύτες Πολύσφηνο 25mm



Κωδικός	Τύπος
27414	4X25
27415	5X25
27416	6X25
27418	8X25

Μύτες Allen 25mm



Κωδικός	Τύπος
27080	1,5X25
27081	2X25
27082	2,5X25
27083	3X25
27084	4X25
27085	5X25
27086	6X25
27087	8X25

Μύτες Allen 50mm



Κωδικός	Τύπος
27193	3X50
27194	4X50
27195	5X50
27196	6X50
27197	8X50

Μύτες παλμικού Phillips



Κωδικός	Τύπος
28520	PH1X38
28521	PH2X38
28522	PH3X38

Μύτες παλμικού Pozidrive



Κωδικός	Τύπος
28523	PZ1X38
28524	PZ2X38
28525	PZ3X38

Μύτες παλμικού Torx



Κωδικός	Τύπος
28490	T15X38
28491	T20X38
28492	T25X38
28493	T30X38
28494	T40X38

Μύτες βιδολόγου με κολλάρο γυψοσανίδας
2 τεμάχια

Κωδικός	Τύπος
967-23-3-0502	PH2x50mm

Καρυδάκια βιδολόγου μαγνητικά εξάγωνα



Κωδικός	Τύπος
967-22-2-06508	8mm
967-22-2-06513	13mm

Μύτες σετ 7 τεμαχίων

PH1
PH2
PZ1
PZ2
0,8X5,5
1,2X6,5



Κωδικός
27623

WITTE
Manufacturing

32 μύτες κατσαβιδιών και μαγνητικός
προσαρμογέας

Fish eye 4,6,8,10mm
Torq 6,8,10mm
Tri-wing #1,#2,#3,#4
Torx με τρύπα T8,T10,T15,T20,
T25,T27,T30,T35,T40
Άλλεν 2,2,5,3,4,5,6,5/32",
9/64",1/8",7/64",3/32",5/64"



Κωδικός Τύπος
2331A 1/4"

FORCE

Σετ 30 μύτες κατσαβιδιών

και μαγνητικός προσαρμογέας
Ίσιες 3-4-5-6,5mm
Phillips PH0-PH1-PH2-PH3
Pozidrive PZ0-PZ1-PZ2-PZ3
Άλλεν 2-2,5-3-4-5-6mm
Torx TT10-TT15-TT20-
TT25-TT27-TT30-TT40



Κωδικός Τύπος
2311 1/4"

FORCE

Μύτες σετ 11 τεμαχίων INOX

Torx:
T10-T40
Phillips:
2XPH2
Pozidriv:
2XPZ2



Κωδικός
28451

WITTE
Manufacturing

Μύτες παλμικών σετ 10 τεμαχίων

Torx:
T15-T30
Phillips:
PH1-PH3
Pozidriv:
PZ1-PZ3



Κωδικός
28477

WITTE
Manufacturing

Μύτες σετ 11 τεμαχίων

Phillips:
PH1-PH3
Pozidriv:
PZ1-PZ3
Ίσιες:
5,5X0,8
6,5X1,2



Κωδικός
28455

WITTE
Manufacturing

Κασετίνα με 38 μύτες Allen, Torx, Spline

● 4-5-6-7-8-10-12 mm (μήκος 30mm)
● 4-5-6-7-8-10-12 mm (μήκος 75mm)
● T20-T25-T30-T40-T45-T50;T55 (μήκος 30mm)
● T20-T25-T30-T40-T45-T50-T55 (μήκος 75mm)
● M5-M6-M8-M10-M12 (μήκος 30mm)
● M5-M6-M8-M10-M12 (μήκος 75mm)
και αντάπτορες για 1/4" & 3/8"

Κωδικός
4401



FORCE

**Μύτες σετ 8 τεμαχίων με γωνιακή λαβή**

Κωδικός	Τύπος
2081A	PH1&2 PZ1&2 ίσιες 4&7mm
2081	Torx T10-15-20-25-27-30-40

FORCE**Μίνι κασάνια με μύτες και καρυδάκια σετ**

Ίσιες 4-5,5-6,5mm
Phillips PH1-PH2-PH3
Hex 3-4-5-6mm
Torx T10-T15-T20-T25-T30
Καρυδάκια
6-7-8-10-13mm



Κωδικός	Τύπος
2222	22 τεμάχια

FORCE**Ταφ με κασάνια**

Για εξάγωνες μύτες 1/4"
Αντοχή: 48Nm



Κωδικός	Τύπος
1517-7-1414	112mm

whirlpower
The Model**Βιδολόγος σπαστός με κασάνια και μύτες**

5,5mm 6,5mm
#1, #2
#1, #2
T15, T20, T25
4mm, 5mm,
6mm



Κωδικός	Τύπος
96-4414	60mm

whirlpower
The Model**Τσοκ βιδολόγου εξάγωνο 1/4"**

Κωδικός	Τύπος
969-5-06314	1-6mm

whirlpower
The Model**Σετ κατσαβίδι με 30 μύτες**

Κωδικός	Τύπος
33557	32 τεμάχια

Kapriol**Σετ κατσαβίδι & κασάνια με μύτες - καρυδάκια**

Κωδικός	Τύπος
33558	40 τεμάχια

Kapriol**Σετ με 30 μύτες μαγν. στέλεχος και αντάπτορα**

Κωδικός	Τύπος
33560	32 τεμάχια

Kapriol

Μαγνητικός αντάπτορας

SDS Plus



Κωδικός
264000001



Μαγνητικός αντάπτορας



Κωδικός
28310



Μαγνητικός αντάπτορας

1/4" X60



Κωδικός
81260



Μαγνητικός αντάπτορας



Κωδικός Τύπος
81260Q 60mm
81280Q 75mm

Μαγνητικός αντάπτορας
σπαστός

Κωδικός Τύπος
260312000 1/4" 50mm

Μαγνητική προέκταση
βιδολόγου 1/4" 175mm

Κωδικός
812175



Μύτες ίσιες για καστάνια 1/4"



Κωδικός Τύπος
3233204 4mm
32332055 5,5mm
32332065 6,5mm



Μύτες Phillips για καστάνια 1/4"



Κωδικός Τύπος
321321 PH1
321322 PH2
321323 PH3



Μύτες Pozidrive για καστάνια



Κωδικός Τύπος
322321 PZ1
322322 PZ2
322323 PZ3



Μύτες allen 30mm



Εξάγωνο καρέ 10mm

Κωδικός	Τύπος	Κωδικός	Τύπος
1743004	4mm	1743010	10mm
1743005	5mm	1743012	12mm
1743006	6mm	1743014	14mm
1743008	8mm		



Μύτες allen μακριές 75mm

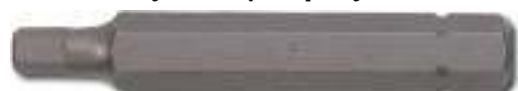

Εξάγωνο καρέ 10mm

Κωδικός	Τύπος	Κωδικός	Τύπος
1747504	4mm	1747508	8mm
1747505	5mm	1747510	10mm
1747506	6mm	1747512	12mm



Μύτες torx 30mm



Εξάγωνο καρέ 10mm

Κωδικός	Τύπος	Κωδικός	Τύπος
1763020	T20	1763040	T40
1763025	T25	1763045	T45
1763027	T27	1763050	T50
1763030	T30	1763055	T55
1763035	T35	1763060	T60



Μύτες torx μακριές 75mm



Εξάγωνο καρέ 10mm

Κωδικός	Τύπος	Κωδικός	Τύπος
1767520	T20	1767545	T45
1767525	T25	1767550	T50
1767530	T30	1767555	T55
1767535	T35	1767560	T60
1767540	T40		



Αντάπτορες βιδολόγων για καρυδάκια 1/4"

Κωδικός Τύπος
8092225 1/4" 25mm
8092250 1/4" 50mm



Πενσάκι

Κωδικός Μήκος
0805110 110mm

**Πένσες**

Κωδικός Μήκος
0202180 180mm
0202200 200mm

**Πένσες μηχανικών**

Κωδικός Μήκος
0302160 160mm
0302180 180mm
0302200 200mm

**Πένσες 1000V**

VDE



Κωδικός Μήκος
0306160 160mm
0306180 180mm
0306200 200mm

**Πένσες**

Κωδικός Μήκος
611B160 160mm
611B175 175mm
611B200 200mm

**Τρυπητήρι δέρματος**

Για τρύπες 2-5 mm



Κωδικός Μήκος
1042204

**Πένσες μολυβδοσφραγίδων**

Κωδικός Τύπος Μήκος
21-420013-0 Ø8mm 130mm
21-418015-0 Ø9mm 150mm
21-418017-0 Ø10mm 170mm
21-420019-0 Ø11mm 190mm

**Σετ πένσα - πλαγιοκόφτης - τσιμπίδα**

002009V01

Κωδικός Περιγραφή
7002160 Πλαγιοκόφτης
160mm
0302180 Πένσα 180mm
8701250 Τσιμπίδα
250mm

**Σετ πένσα - πλαγιοκόφτης - μυτοτσίμπιδο**

002011

Κωδικός Περιγραφή
7002160 Πλαγιοκόφτης
160mm
0302180 Πένσα 180mm
2612200 Μυτοτσίμπιδο
200mm



**Πένσα ασφαλειών 140mm**

Κωδικός **Τύπος**
4811J0 IXE 8-13

**Πένσα ασφαλειών 140mm**

Κωδικός **Τύπος**
4811J1 IXE 12-25

**Πένσα ασφαλειών 180mm**

Κωδικός **Τύπος**
4811J2 IXE

**Πένσα ασφαλειών 225mm**

Κωδικός **Τύπος**
4811J3 IXE

**Πένσα ασφαλειών γωνιακή 130mm**

Κωδικός **Τύπος**
4821J01 KXE 8-13

**Πένσα ασφαλειών γωνιακή 130mm**

Κωδικός **Τύπος**
4821J11 KXE 12-25

**Πένσα ασφαλειών γωνιακή 165mm**

Κωδικός **Τύπος**
4821J21 KXE

**Πένσα ασφαλειών γωνιακή 210mm**

Κωδικός **Τύπος**
4821J31 KXE

**Πένσα ασφαλειών 140mm**

Κωδικός **Τύπος**
4911A0 IME 3-10

**Πένσα ασφαλειών 140mm**

Κωδικός **Τύπος**
4911A1 IME 10-25



Πένσα ασφαλειών 180mm



Κωδικός Τύπος
4911A2 ΙΜΕ



Πένσα ασφαλειών 225mm



Κωδικός Τύπος
4911A3 ΙΜΕ



Πένσα ασφαλειών γωνακή 130mm



Κωδικός Τύπος
4921A01 ΚΜΕ 3-10



Πένσα ασφαλειών γωνακή 130mm



Κωδικός Τύπος
4921A11 ΚΜΕ 10-25



Πένσα ασφαλειών γωνακή 165mm



Κωδικός Τύπος
4921A21 ΚΜΕ



Πένσα ασφαλειών γωνακή 210mm



Κωδικός Τύπος
4921A31 ΚΜΕ



Μυτοτσιμπίδα ασφαλειών ίσια που κλείνουν



Κωδικός	Ανοιγμα	Μύτη	Επαναφορά
60905ASC	8-25mm	1,3mm	✓
609ASC	19-60mm	1,9mm	✓
60909ASC	40-100mm	2,3mm	✓
60912ASC	85-165mm	3,2mm	✗



Μυτοτσιμπίδα ασφαλειών ίσια που ανοίγουν



Κωδικός	Ανοιγμα	Μύτη	Επαναφορά
60905ASO	8-25mm	1,3mm	✓
609ASO	19-60mm	1,9mm	✓
60909ASO	40-100mm	2,3mm	✓
60912ASO	85-165mm	3,2mm	✓



Μυτοτσιμπίδα ασφαλειών κυρτά που κλείνουν



Κωδικός	Ανοιγμα	Μύτη	Επαναφορά
60905ABC	8-25mm	1,3mm	✓
609ABC	19-60mm	1,9mm	✓
60909ABC	40-100mm	2,3mm	✓
60912ABC	85-165mm	3,2mm	✓



Μυτοτσιμπίδα ασφαλειών κυρτά που ανοίγουν



Κωδικός	Ανοιγμα	Μύτη	Επαναφορά
60905ABO	8-25mm	1,3mm	✓
609ABO	19-60mm	1,9mm	✓
60909ABO	40-100mm	2,3mm	✓
60912ABO	85-165mm	3,2mm	✓





Πένσα ασφαλειών



Κωδικός Τύπος
371004 J4 310



Πένσα ασφαλειών γωνιακή



Κωδικός Τύπος
373041 ΚΧΕ J41 310



Πένσα ασφαλειών γωνιακή



Κωδικός Τύπος
377041 A41 310



Πένσα ασφαλειών πιστονιών

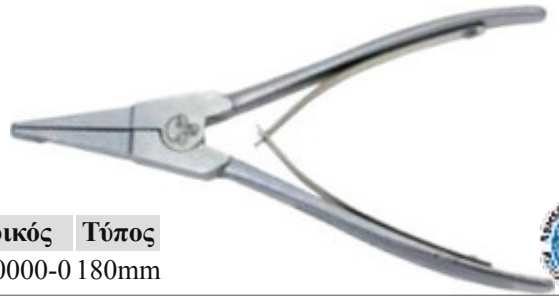

Κωδικός Τύπος
21-370000-0 180mm



Μυτοσίμπιδα ίσια

Κωδικός Μήκος
610B160 160mm
610B200 200mm

**Μυτοσίμπιδα κυρτά**

Κωδικός Μήκος
610B150B 150mm
610B200B 200mm

**Μυτοσίμπιδο μακρύλαιμο**

Κωδικός Μήκος
5047P1 280mm

**Μυτοσίμπιδο μακρύλαιμο κυρτό**

Κωδικός Μήκος
5047P2 280mm

**Μυτοσίμπιδο μακρύλαιμο για μπουζί**

Κωδικός Μήκος
5047P4 280mm

**Μυτοσίμπιδο πολυχρηστικό**

Πένσα, μυτοσίμπιδο, κόφτης, απογυμνωτής, πρέσα ακροδεκτών



Κωδικός Μήκος
1392200 200mm

**Μυτοσίμπιδο πολυχρηστικό 1000V**

Πένσα, μυτοσίμπιδο, κόφτης, απογυμνωτής, πρέσα ακροδεκτών
Χωρίς ελατήριο



Κωδικός Μήκος
1386200 200mm

**Μυτοσίμπιδο πολυχρηστικό 1000V**

Πένσα, μυτοσίμπιδο, κόφτης, απογυμνωτής, πρέσα ακροδεκτών



Κωδικός Μήκος
1396200 200mm

**Μυτοσίμπιδο με πλαγιοκόφτη**

Κωδικός Μήκος
2502160 160mm
2612200 200mm

**Μυτοσίμπιδο με πλαγιοκόφτη 1000V**

Κωδικός Μήκος
2506160 160mm
2616200 200mm



**Μυτοσίμπιο με πλαγιοκόφτη κυρτό**

Κωδικός Μήκος
2521160 160mm
2621200 200mm

**Στρογγυλοτσίμπιο**

Κωδικός Μήκος
1901130 130mm

**Μυτοσίμπιο με πλαγιοκόφτη κυρτό**

Κωδικός Μήκος
2622200 200mm

**Μυτοσίμπιο με πλαγιοκόφτη κυρτό 1000V**

Κωδικός Μήκος
2526160 160mm
2626200 200mm

**Μυτοσίμπιο για μπουζί**

Κωδικός Μήκος
3891200 200mm

**Προσέλα τιτανίου ίσια**

Κωδικός Μήκος
922305 120mm

**Προσέλα αντιστατική ίσια**

Κωδικός Μήκος
922872 ESD 135mm

**Προσέλα αντιστατική πλάγια**

Κωδικός Μήκος
923875 ESD 120mm

**Τσιμπίδα ίσια 1000V**

Κωδικός Μήκος
922761 150mm

**Τσιμπίδα πλάγια 1000V**

Κωδικός Μήκος
923764 150mm



Κοφτάκι μίνι

Κωδικός	Μήκος	Τύπος
7702115	115mm	Cu 1.6mm/Fe 0.6mm
7712115	115mm	Cu 1.6mm/Fe 0.6mm
7902120	120mm	Cu 1.4mm/Fe 0.6mm
7813125	125mm	Cu 1.6mm/Fe 1.0mm
7722115	115mm	

**Εμπροσθοκόφτης λοξός μίνι**

Για πλακέτες



Κωδικός	Μήκος
6462120	120mm

**Κοφτάκι μίνι αντιστατικό μυτερό**

Κωδικός	Μήκος
7732115 ESD	115mm

**Πλαγιοκόφτης**

Κωδικός	Μήκος
1422160	160mm

**Πλαγιοκόπτες καλωδίων**

Κωδικός	Μήκος
7002140	140mm
7002160	160mm
7002180	180mm

**Πλαγιοκόφτες**

Κωδικός	Μήκος
7302160	160mm

**Πλαγιοκόφτες ατσαλοσύρματος**

Κωδικός	Μήκος
7402160	160mm
7402180	180mm
7402200	200mm

**Πλαγιοκόφτης 1000V**

Κωδικός	Μήκος
1426160	160mm

**Πλαγιοκόφτες καλωδίων 1000V**

Κωδικός	Μήκος
7006160	160mm
7006180	180mm

**Πλαγιοκόφτης 1000V**

Κωδικός	Μήκος
7306160	160mm



Κόφτες σύρματος



Κωδικός Μήκος
612B160 160mm
612B175 175mm

FORCE

Πλαγιοκόφτης μεγάλης ισχύος



Κωδικός Μήκος
732180 180mm

ΚΝΙΡΕΧ

Πλαγιοκόφτης μακρύς



Κωδικός Μήκος
7491250 250mm

ΚΝΙΡΕΧ

Ψαλίδι καλωδίων Ø15



Κωδικός Μήκος
9511165 165mm

ΚΝΙΡΕΧ

Ψαλίδι καλωδίων

Με ελατήριο επαναφοράς



Κωδικός Μήκος
9522165 165mm

ΚΝΙΡΕΧ

Ψαλίδι καλωδίων



Κωδικός Μήκος
9512165 165mm

ΚΝΙΡΕΧ

Ψαλίδι καλωδίων 1000V



Κωδικός Μήκος
9516165 165mm

ΚΝΙΡΕΧ

Ψαλίδι καλωδίων



Κωδικός Μήκος
9512200 200mm

ΚΝΙΡΕΧ

Ψαλίδι καλωδίων 1000V



Κωδικός Μήκος
9516200 200mm

ΚΝΙΡΕΧ

Κόφτης καλωδίων με καστάνια ≤Ø52



Κωδικός Μήκος
9531280 280mm

ΚΝΙΡΕΧ

Κόφτης καλωδίων με καστάνια ≤Ø60



Κωδικός Μήκος
9532320 320mm

ΚΝΙΡΕΧ

Εμπροσθοκόφτης μετου με μόνωση



Κωδικός Μήκος
33132 180mm



Εμπροσθοκόφτες μετου

Κωδικός	Μήκος
6801160	160mm
6801180	180mm
6801180S2	180mm Με μουστάκια
6801200	200mm
6801200S2	200mm Με μουστάκια
6801280	280mm



Εμπροσθοκόφτης μετου με μόνωση



Κωδικός Μήκος
6705200 200mm



Εμπροσθοκόφτης μετου με μόνωση



Κωδικός Μήκος
9911250 250mm



Εμπροσθοκόφτης - σφυρί



Κωδικός Μήκος
5500300 300mm



Τανάλια



Κωδικός Τύπος
6972180 180mm



Πενσοτανάλια ψηφίδων & πλακιδίων

V-TYPE

■ *Made in Japan*



Κωδικός Τύπος
5203-003 200mm



Κόφτης συρματόσχοινο



Κωδικός Τύπος
1643-200 3/16" 200mm



Κόφτης καλωδίων - συρματόσχοινο



Κωδικός Μήκος
9561190 190mm



Ψαλίδι σύρματος με λάμες τιτανίου

Κόβει: Μαλακό ατσάλι: 4mm Σκληρό ατσάλι: 2mm

■ *Made in Japan*



Κωδικός Τύπος
THC-8Ti 200mm



Κόφτης ατσαλοσύρματος



Κωδικός Μήκος
7101200 200mm



Κόφτης ατσαλοσύρματος



Κωδικός Μήκος
7112200 200mm



Κόφτες συρματόσχοινου



Κωδικός	Τύπος
6927310	≤Ø7mm 310mm
6927600	≤Ø14mm 600mm



Κόφτες μετου ΒΤ Ιταλίας



Κωδικός	Τύπος
20831	480mm 7N
20841	650mm 9N
20851	750mm 12N
20861	900mm 14N



Επαγγελματικά μετοψάλιδα **NEO**

Ιδανικά για την κοπή ράβδων από μαλακό χάλυβα, μαλακά σύρματα, σκληρές ράβδους χαλκού, κολλημένα σύρματα κλπ. Made in Japan



Κωδικός	Μέγεθος	Ικανότητα κοπής			Βάρος
		JIS	50kgf/mm ² HRB80	75kgf/mm ² HRC80	
TP-1800	455mm (18")	Ø6	Ø8	Ø7	1,4kg
TP-2400	610mm (24")	Ø8	Ø10	Ø9	2,5kg
TP-3000	770mm (30")	Ø10	Ø12	Ø11	3,9kg
TP-3600	930mm (36")	Ø13	Ø15	Ø13	5,6kg
TP-4200	1050mm (42")	Ø16	Ø18	Ø15	8,1kg



Απογυμωτής καλωδίων



Κωδικός	Μήκος
1102160	160mm



Απογυμωτής καλωδίων 1000V



Κωδικός	Μήκος
1106160	160mm



Απογυμωτής ομοαξονικών καλωδίων



Κωδικός	Μήκος
166005SB	105mm



Απογυμωτής τηλεφωνικών καλωδίων



Κωδικός	Μήκος
166006SB	125mm



Απογυμωτής καλωδίων

Για ομοαξονικά, πολύκλινα και καλώδια δικτύου



Κωδικός	Μήκος
169501SB	135mm



Απογυμωτής καλωδίων

Με κόφτη



Κωδικός	Τύπος
6804	≤3,5mm ²



**Απογυμνωτής καλωδίων αυτόματος**

Με κόφτη

Κωδικός Μήκος
1262180 180mm**Απογυμνωτής αυτόματος**

Με κόφτη

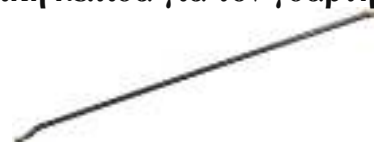
Κωδικός Μήκος
1242195 195mm**Απογυμνωτής αυτόματος**Κωδικός Μήκος
1221180 180mm**Γδάρτης καλωδίων**Κωδικός Μήκος
1690130SB 130mm**Γδάρτης καλωδίων 25mm και άνω**Κωδικός Μήκος
1640150 150mm**Γδάρτης καλωδίων 1000V**Κωδικός Μήκος
9855 180mm**Γδάρτης καλωδίων**Κωδικός Μήκος
1620165SB 165mm**Ανταλλακτική λεπίδα για τον γδάρτη 1620165SB**Κωδικός Μήκος
1629165**Γδάρτης καλωδίων**Κωδικός Μήκος
1630135SB 165mm**Γδάρτης καλωδίων**Κωδικός Μήκος
1685125SB 125mm**Πρέσα ακροδεκτών**Κωδικός Μήκος
9771180 180mm**Πρέσα ακροδεκτών 1000V**Κωδικός Μήκος
9778180 180mm

Πρέσα ακροδεκτών

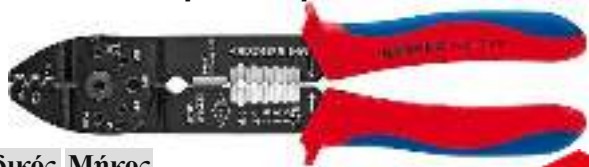

Κωδικός Μήκος
9721215B 215mm



Πρέσα τηλεφωνικών βυσμάτων



Κωδικός Τύπος
68012 RJ45 & RJ11



Πρέσα τοποθέτησης τηλεφωνικών βυσμάτων



Κωδικός Μήκος
975112 200mm



Πρέσα μονωμένων ακροδεκτών καλωδίων



Κωδικός Τύπος
6801 233mm



Πρέσα μονωμένων ακροδεκτών καλωδίων



Κωδικός Τύπος
6802 233mm



Πρέσα γυμνών ακροδεκτών καλωδίων



Κωδικός Τύπος
6803 233mm



Αυτορυθμιζόμενη πρέσα ακροδεκτών



Κωδικός Τύπος
975304 180mm



Πολυπρέσσα καλωδίων με μύλο



Κωδικός Μήκος
973302 250mm

Πολυπρέσσα ομοαξονικών **NEO**

BNC, RG58/174/188/316



Κωδικός Μήκος
975250 220mm



Πρέσα ακροδεκτών



Κωδικός Τύπος
68071 10-120mm²



Πρέσες ταλουρίτ



Κωδικός Τύπος Μήκος
1655-014 1,5-4mm 350mm
1655-024 1,5-5mm 600mm



Κλειδί φίλτρου με ιμάντα

Κωδικός Διάμετρος
61908 ≤110mm

FORCE

Φιλτρόκλειδο ιμάντα

Κωδικός Διάμετρος
61912 200mm

FORCE

Κλειδί φίλτρου με ιμάντα BT

Κωδικός Διάμετρος
04260001 ≤240mm

MATADOR

Φιλτρόκλειδο με ιμάντα Ø25 - Ø160

Κωδικός Τύπος
U022-03-225 225mm

whirlpower

Φιλτρόκλειδο καδένας

Κωδικός Τύπος
61911 110mm

FORCE

Φιλτρόκλειδο καδένας

Μήκος αλυσίδας: 580mm. Λαβή: 225mm.



Κωδικός Τύπος
61918 Ø30 - Ø160mm

FORCE

Αρπάγη φίλτρου λαδιού με καρέ 1/2" & 3/8"

Κωδικός Τύπος
61904A 63-102mm

FORCE

Ιμάντας φίλτρου λαδιού με καρέ 1/2"

Κωδικός Τύπος
619 Ø50-Ø150mm

FORCE

Αρπάγη φίλτρου λαδιού με καρέ 1/2"

Κωδικός Τύπος
61904 65mm-120mm

FORCE

Κλειδί φίλτρου με λάμα

Κωδικός Διάμετρος
61910 Ø65-Ø110
61910L Ø110-Ø155

FORCE

Αλυσίδα φίλτρων λαδιού 1/2"

Κωδικός Τύπος
61901 ≤Ø120mm

FORCE

Σετ 14 φιλτρόκλειδα καμπάνα

65mm/14P, 65-67mm/14P,
68mm/14P, 73mm/14P,
74-76mm/15P, 75-77mm/15P,
76mm/14P, 76mm/30P,
80mm/15P, 80-82mm/15P
90mm/15P, 93mm/15P,
93mm/36P, 100mm/15P



Κωδικός Τύπος

61915 1/2"-3/8"



Σετ ταπόκλειδα

17mm Hex - 14mm Hex, 10mm Hex - 12mm Hex,
9mm Hex - 5/16" Hex, 8mm Sq. - 13mm Sq., 3/8" Sq. -
11mm Sq.



Κωδικός Τύπος

5051 5 τεμάχια



Κλειδί τάπας λαδιού 9 τύπων



Κωδικός

890220



Ταπόκλειδο 'Z' 8-10mm

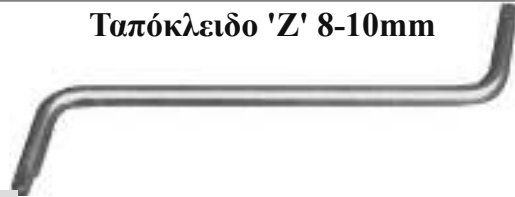

Κωδικός

9U0706



Πένσα κολιέδων

Κωδικός Μήκος
62519

**Πένσα κολιέδων**

Κωδικός Μήκος
62520

**Πένσα κολιέδων boot clamp**

Μέγιστο άνοιγμα 30mm



Κωδικός Τύπος
9G0104 170mm

**Ειδική πένσα σφιξίματος - αφαίρεσης ελατηριωτών κολάρων**

Κωδικός
62518

**Πένσες εξαγωγής για τσιμούχες βαλβίδων**

Κωδικός Τύπος
9G0102 250mm
9G0103 280mm

**Εργαλείο σύσφιξης σφυγκτήρων ημιαξονίου**

- ο Για την τοποθέτηση σφυγκτήρων inox νέου τύπου που απαιτείται υψηλή δύναμη
- ο Υποδοχή στο καρδάκι 3/8 Vape
- ο Κατάλληλο για: VW AUDI SEAT SKODA OPEL VAUXHALL FORD



Κωδικός
62527

**Εύκαμπτη πένσα σφυγκτήρων**

Κωδικός Τύπος
9G0201 10-100mm



Γκαζοτανάλια ίσια

Κωδικός Μήκος
8201200 200mm

Γκαζοτανάλια ίσια με μόνωση

Κωδικός Μήκος
8202200 200mm

Γκαζοτανάλια με μαλακά σαγόνια

Κωδικός Μήκος
8113250 250mm

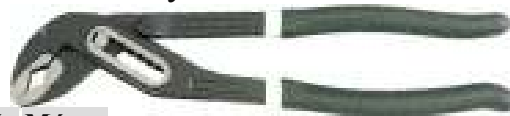
Γκαζοτανάλια 250mm

Κωδικός Μήκος
613B250 250mm

FORCE

Γκαζοτανάλια 7 θέσεων

Κωδικός Μήκος
8801300 300mm

**Γκαζοτανάλια 1000V**

Κωδικός Μήκος
8726250 250mm

**Γκαζοτανάλια παπαγαλάκι**

Κωδικός Μήκος
8741250 250mm

**Γκαζοτανάλια με μακριά μύτη**

Κωδικός Μήκος
8751250 250mm

**Γκαζοτανάλια για σφιγκτήρες**

Κωδικός Μήκος
8551250A 250mm

**Γκαζοτανάλια Ø2" με αυτόματη ρύθμιση**

Κωδικός Μήκος
8721250 250mm

**Γκαζοτανάλια Ø2" ΒΤ**

Κωδικός Μήκος
8702250 250mm

**Τσιμπίδες υδραυλικού με αυτόματη ρύθμιση**

Κωδικός Μήκος
8501250 250mm

**Γκαζοτανάλια κλειδί μονωμένη**

Κωδικός Μήκος
8605250 250mm

**Γκαζοτανάλιες υδραυλικών**

Κωδικός	Μήκος	Κωδικός	Μήκος
8701125	125mm	8701300	300mm
8701150	150mm	8701400	400mm
8701180	180mm	8701560	560mm
8701250	250mm		

**Γκαζοτανάλιες κλειδιά**

Κωδικός	Μήκος	Κωδικός	Μήκος
8604100	100mm γυμνή	8603250	250mm
8603125	125mm	8603300	300mm
8603150	150mm	8603400	400mm
8603180	180mm		



Τσιμπίδες υδραυλικών 90°**Κωδικός** **Μήκος**

1110302 3"

1110402 4"

**Τσιμπίδες υδραυλικών αυτόματες****Κωδικός** **Μήκος**

8360010 330mm

8360015 420mm

**Κάβουρες αλουμινίου****Κωδικός** **Τύπος** **Κωδικός** **Τύπος**

68410A 10" 68424A 24"

68412A 12" 68436A 36"

68414A 14" 68448A 48"

68418A 18"

**Γκριπ****Κωδικός** **Μήκος**

1601804 180mm

1602504 250mm

1603004 300mm

**Γκριπ με ίσια σαγόνια****Κωδικός** **Μήκος**

1632504 250mm

**Γκριπ με διπλά σαγόνια****Κωδικός** **Μήκος**

66201 280mm

**Γκριπ με διπλά σαγόνια****Κωδικός** **Μήκος**

1712804 280mm

**Γκριπ με βαθιά εσοχή (0-80mm)**

Σπαστή σαγόνια 0-80mm

**Κωδικός** **Μήκος**

66011D 280mm

**Γκριπ με βαθιά εσοχή (0-80mm)**

Σπαστή σαγόνια 0-80mm

**Κωδικός** **Μήκος**

1732804 280mm



Ψαλίδι σωλήνων PVC



Κωδικός Τύπος
1050009 Ø42

Ψαλίδι σωλήνων PVC



Κωδικός Τύπος
1695-042 42mm

TorMan

Σωληνοκόφτης



Κωδικός Τύπος
903102SB Ø3-35mm



Σωληνοκόφτης σωλήνων αποχέτευσης



Κωδικός Τύπος
902301BK Ø32-40-50mm



Ψαλίδι πλαστικών σωλήνων



Κωδικός Μήκος
902520 210mm



Κόφτης πλαστικών σωλήνων

Μίνι



Κωδικός Τύπος
902210BK Ø20-50mm



Ταπόνη



Κωδικός
21-218000-0



Κουρμαδόρος χαλκοσωλήνων 0-180°



Κωδικός Τύπος
65301 Ø6,8-10mm



Κλειδιά κουρμαδόροι



Κωδικός Μήκος
20600 Ø6/Ø8
20610 Ø8/Ø10
20620 Ø10/Ø12

Πένσα σιδηρουργού **NEO**

Κωδικός
30-635060-0



Σετ γερμανικά κλειδιά 8 τεμαχίων

6x7, 8x9, 10x11, 12x13, 14x15, 16x17, 18x19, 20x22mm



Κωδικός
5084



Σετ γερμανικά κλειδιά 12 τεμαχίων

6x7 8x9 10x11
12x13 14x15
16x17 18x19
20x22 21x23
24x27 25x28
30x32



Κωδικός Τύπος
5128P 12 τεμ
5128C 12 τεμ



Γερμανικά κλειδιά



Κωδικός	Διατομή	Κωδικός	Διατομή
7540506	5-6	7541819	18-19
7545507	5,5-7	7542022	20-22
7540607	6-7	7542123	21-23
7540809	8-9	7542426	24-26
7541011	10-11	7542427	24-27
7541013	10-13	7542528	25-28
7541213	12-13	7542729	27-29
7541415	14-15	7543032	30-32
7541617	16-17	7543436	34-36
7541719	17-19	7543641	36-41



Γαλλικά κλειδιά



Κωδικός	Διατομή	Μήκος	Κωδικός	Διατομή	Μήκος
649100A	17mm	100mm	649300A	33mm	300mm
649150A	20mm	150mm	649375A	46mm	375mm
649200A	24mm	200mm			
649250A	29mm	250mm			



Γαλλικό κλειδί 450mm



Κωδικός Τύπος
649450 18"



Γερμανικά κλειδιά σφύρας



Κωδικός	Διατομή	Κωδικός	Διατομή	Κωδικός	Διατομή	Κωδικός	Διατομή
79122	22	79130	30	79143	43	79156	56
79123	23	79132	32	79144	44	79158	58
79124	24	79133	33	79145	45	79160	60
79125	25	79134	34	79146	46	79165	65
79126	26	79135	35	79148	48	79170	70
79127	27	79136	36	79150	50	79175	75
79128	28	79138	38	79152	52	79180	80
79129	29	79141	41	79155	55		



Γαντζόκλειδα με νύχι



Κωδικός	Άνοιγμα	Κωδικός	Άνοιγμα
823035	15-35mm	823120	80-120mm
823050	35-50mm	823180	120-180mm
823080	50-80mm		



Γαντζόκλειδα με πείρο



Κωδικός	Άνοιγμα	Κωδικός	Άνοιγμα
823A035	13-35mm	823A120	80-120mm
823A050	35-50mm	823A180	120-180mm
823A080	50-80mm		



Γερμανοπολύγωνα



Κωδικός	Ανοιγμα	Κωδικός	Ανοιγμα	Κωδικός	Ανοιγμα	Κωδικός	Ανοιγμα
75506	6mm	75516	16mm	75526	26mm	75538	38mm
75507	7mm	75517	17mm	75527	27mm	75541	41mm
75508	8mm	75518	18mm	75528	28mm	75542	42mm
75509	9mm	75519	19mm	75529	29mm	75546	46mm
75510	10mm	75520	20mm	75530	30mm	75548	48mm
75511	11mm	75521	21mm	75532	32mm	75550	50mm
75512	12mm	75522	22mm	75533	33mm	75555	55mm
75513	13mm	75523	23mm	75534	34mm	75560	60mm
75514	14mm	75524	24mm	75535	35mm		
75515	15mm	75525	25mm	75536	36mm		

Γερμανοπολύγωνα μακριά



Κωδικός	Τύπος	Μήκος	Κωδικός	Τύπος	Μήκος	Κωδικός	Τύπος	Μήκος	Κωδικός	Τύπος	Μήκος
75506L	6mm	128mm	75512L	12mm	196mm	75518L	18mm	272mm	75524L	24mm	339mm
75507L	7mm	138mm	75513L	13mm	205mm	75519L	19mm	281mm	75527L	27mm	388mm
75508L	8mm	148mm	75514L	14mm	223mm	75520L	20mm	301mm	75530L	30mm	404mm
75509L	9mm	160mm	75515L	15mm	233mm	75521L	21mm	301mm	75532L	32mm	431mm
75510L	10mm	167mm	75516L	16mm	243mm	75522L	22mm	319mm	75533L	33mm	471mm
75511L	11mm	186mm	75517L	17mm	262mm	75523L	23mm	329mm	75536L	36mm	510mm

Γερμανοπολύγωνα ίντσας



Κωδικός	Ανοιγμα	Κωδικός	Ανοιγμα
7551.4	1/4"	75513.16	13/16"
7555.16	5/16"	7557.8	7/8"
7553.8	3/8"	75515.16	15/16"
7557.16	7/16"	7551.0	1"
7551.2	1/2"	7551.1.8	1 1/8"
7559.16	9/16"	7551.1.4	1 1/4"
7555.8	5/8"	7551.5.16	1 5/16"
75511.16	11/16"	7551.3.8	1 3/8"
7553.4	3/4"	7551.1.2	1 1/2"

Γερμανοπολύγωνα καστανίας



Κωδικός	Ανοιγμα	Κωδικός	Ανοιγμα
75708	8mm	75717	17mm
75709	9mm	75718	18mm
75710	10mm	75719	19mm
75711	11mm	75720	20mm
7577.16	7/16"	75721	21mm
75712	12mm	75722	22mm
75713	13mm	75723	23mm
75714	14mm	75724	24mm
75715	15mm		
75716	16mm		

Γερμανοπολύγωνα καστανίας σπαστά



Κωδικός	Ανοιγμα	Κωδικός	Ανοιγμα
75708F	8mm	75715F	15mm
75709F	9mm	75716F	16mm
75710F	10mm	75717F	17mm
75711F	11mm	75718F	18mm
75712F	12mm	75719F	19mm
75713F	13mm		
75714F	14mm		

Γερμανοπολύγωνα κλειδιά καστανίας σταθερά με επιλογή φοράς



Κωδικός	Τύπος
75713R	13mm
75717R	17mm
75719R	19mm

**Γερμανοπολύγωνα καστανίας σπαστά σε ίντσες**

Κωδικός	Τύπος	Κωδικός	Τύπος
7575.16F	5/16"	7579.16F	9/16"
7573.8F	3/8"	7575.8F	5/8"
7577.16F	7/16"	7573.4F	3/4"
7571.2F	1/2"		

**Πολύγωνα κλειδιά**

Κωδικός	Ανοιγμα	Κωδικός	Ανοιγμα
7590607	6X7mm	7592123	21X23mm
7590809	8X9mm	7592426	24X26mm
7591011	10X11mm	7592427	24X27mm
7591213	12X13mm	7592528	25X28mm
7591415	14X15mm	7592730	27X30mm
7591617	16X17mm	7592732	27X32mm
7591819	18X19mm	7593032	30X32mm
7592022	20X22mm		

**Πολύγωνα κοφτά**

Κωδικός	Ανοιγμα	Κωδικός	Ανοιγμα
7510810	8X10mm	7511618	16X18mm
7510911	9X11mm	7511719	17X19mm
7511011	10X11mm	7511819	18X19mm
7511012	10X12mm	7511922	19X22mm
7511113	11X13mm	7512427	24X27mm
7511213	12X13mm	7513032	30X32mm
7511214	12X14mm	7513236	32X36mm
7511415	14X15mm		

**Πολύγωνα κλειδιά ίσια**

Κωδικός	Ανοιγμα	Κωδικός	Ανοιγμα
760M0607	6X7mm	760M2022	20X22mm
760M0809	8X9mm	760M2123	21X23mm
760M1011	10X11mm	760M2224	22X24mm
760M1213	12X13mm	760M2628	26X28mm
760M1415	14X15mm	760M2729	27X29mm
760M1617	16X17mm	760M3032	30X32mm
760M1819	18X19mm		

**Πολύγωνα κυρτά**

Κωδικός	Ανοιγμα	Κωδικός	Ανοιγμα
7610810	8X10mm	7611417	14X17mm
7611012	10X12mm	7611618	16X18mm
7611113	11X13mm	7611719	17X19mm
7611214	12X14mm	7611922	19X22mm
7611315	13X15mm		

**Γερμανοπολύγωνα Duo Action**

Κωδικός	Τύπος	Κωδικός	Τύπος
1248-8-08	8mm	1248-8-14	14mm
1248-8-09	9mm	1248-8-15	15mm
1248-8-10	10mm	1248-8-16	16mm
1248-8-11	11mm	1248-8-17	17mm
1248-8-12	12mm	1248-8-18	18mm
1248-8-13	13mm	1248-8-19	19mm

**Πολύγωνα σφύρας**

Κωδικός	Ανοιγμα	Κωδικός	Ανοιγμα	Κωδικός	Ανοιγμα
79322	22	79330	30	79340	40
79324	24	79332	32	79341	41
79325	25	79333	33	79346	46
79326	26	79334	34	79348	48
79327	27	79335	35	79350	50
79328	28	79336	36	79355	55
79329	29	79338	38	79360	60



Καρυδάκια πίπα

Κωδικός	Ανοιγμα	Κωδικός	Ανοιγμα
75308	8mm	75317	17mm
75309	9mm	75318	18mm
75310	10mm	75319	19mm
75311	11mm	75320	20mm
75312	12mm	75321	21mm
75313	13mm	75322	22mm
75314	14mm		
75315	15mm		
75316	16mm		

**Σωληνωτά κλειδιά**

Κωδικός	Ανοιγμα	Κωδικός	Ανοιγμα
23-180001-0	6-7	23-180031-0	25-28
23-180002-0	8-9	23-180034-0	30-32
23-180006-0	10-11	23-180035-0	30-36
23-180012-0	12-13	23-180036-0	32-36
23-180017-0	14-15	23-180037-0	36-41
23-180019-0	16-17	23-180039-0	46-50
23-180022-0	18-19	23-180038-0	41-46
23-180025-0	20-22	23-180042-0	50-55
23-180026-0	21-23	23-180043-0	55-60
23-180028-0	24-26		
23-180029-0	24-27		

**Κλειδιά Torx τύπου E ίσια**

Κωδικός	Τύπος	Μήκος
7560607	E6 - E7	112mm
7560608	E6 - E8	112mm
7560711	E7 - E11	125mm
7561012	E10 - E12	140mm
7561418	E14 - E18	180mm
7561622	E16 - E22	200mm
7562024	E20 - E24	224mm

**Κλειδιά Torx τύπου E γωνιακό 75°**

Κωδικός	Τύπος	Μήκος
7561012A	E10 - E12	175mm
7561418A	E14 - E18	215mm
7561622A	E16 - E22	235mm

**Κλειδιά φρένων**

Κωδικός	Τύπος
6080810	8-10 κλειστό
6080911	9-11 κλειστό
6081011	10-11 ανοικτό
6081113	11-13 ανοικτό

**Κλειδί με πείρους για παξιμάδια με εγχοπές**

Κωδικός	Ανοιγμα	Διατομή
23-179002-0	7-40mm	2mm
23-179003-0	11-60mm	3mm
23-179004-0	11-60mm	4mm
23-179005-0	14-100mm	5mm
23-179006-0	14-100mm	6mm

**Κλειδί γωνιακού τροχού NEO**

Κωδικός	Τύπος
229.00	35mm



**Σετ γερμανικά κλειδιά 11 τεμαχίων**

6X7-8X9-10X11-12X13-14X15-16X17-18X19-20X22-21X23-24X27-30X32



Κωδικός

5111

**Σετ γερμανοπολύγωνα καστανίας 12 τεμαχίων**

Μεταλλική κασετίνα



Κωδικός

51210M

**Σετ γερμανοπολύγωνα 26 τεμαχίων**

6-32mm



Κωδικός

5261C

**Σετ γερμανοπολύγωνα 12 τεμαχίων**

Κωδικός Τύπος

5121C 8-23mm

**Σετ γερμανοπολύγωνα καστανίας 12 τεμαχίων**Σπαστά
8-19mm

Κωδικός

K51210F

**Σετ πολύγωνα κλειδιά 8 τεμαχίων**

6X7, 8X9, 10X11, 12X13, 14X15, 16X17, 18X19, 21X22



Κωδικός

5081

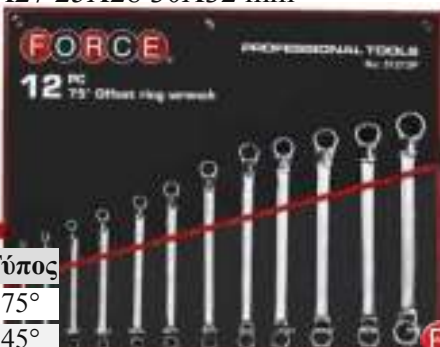
**Σετ πολύγωνα κλειδιά 12 τεμαχίων**6X7 8X9 10X11 12X13 14X15 16X17 18X19 20X22
21X23 24X27 25X28 30X32 mm

Κωδικός Τύπος

51213P-8 75°

51213C 45°

**Σετ γερμανοπολύγωνα κλειδιά 12 τεμαχίων**

8-22 mm



Κωδικός

5123



Κλειδιά allen κοντά



Κωδικός	Άνοιγμα	Κωδικός	Άνοιγμα	Κωδικός	Άνοιγμα	Κωδικός	Άνοιγμα
911-0100	1mm	911-0450	4,5mm	911-1100	11mm	911-1900	19mm
911-0127	1,27mm	911-0500	5mm	911-1200	12mm	911-2000	20mm
911-0150	1,5mm	911-0550	5,5mm	911-1300	13mm	911-2100	21mm
911-0200	2mm	911-0600	6mm	911-1400	14mm	911-2200	22mm
911-0250	2,5mm	911-0700	7mm	911-1500	15mm	911-2400	24mm
911-0300	3mm	911-0800	8mm	911-1600	16mm	911-2700	27mm
911-0350	3,5mm	911-0900	9mm	911-1700	17mm	911-3000	30mm
911-0400	4mm	911-1000	10mm	911-1800	18mm	911-3200	32mm

ARNDT

Κλειδιά allen κοντά σε ίντσες



Κωδικός	Άνοιγμα	Κωδικός	Άνοιγμα	Κωδικός	Άνοιγμα
911-CV-B-0116	1/16"	911-CV-B-0316	3/16"	911-CV-B-0120	1/2"
911-CV-B-0564	5/64"	911-CV-B-0140	1/4"	911-CV-B-0916	9/16"
911-CV-B-0332	3/32"	911-CV-B-0932	9/32"	911-CV-B-0580	5/8"
911-CV-B-0180	1/8"	911-CV-B-0516	5/16"	911-CV-B-0340	3/4"
911-CV-B-0964	9/64"	911-CV-B-0380	3/8"	911-CV-B-0780	7/8"
911-CV-B-0532	5/32"	911-CV-B-0716	7/16"	911-CV-B-10000	1"

ARNDT

Κλειδιά allen μακριά



Κωδικός	Άνοιγμα	Κωδικός	Άνοιγμα
911L-0200	2mm	911L-0550	5,5mm
911L-0250	2,5mm	911L-0600	6mm
911L-0300	3mm	911L-0700	7mm
911L-0350	3,5mm	911L-0800	8mm
911L-0400	4mm	911L-1000	10mm
911L-0450	4,5mm	911L-1200	12mm
911L-0500	5mm		

ARNDT

Κλειδιά allen μακριά μπίλιας



Κωδικός	Άνοιγμα	Κωδικός	Άνοιγμα
302-0200	2mm	302-0600	6mm
302-0250	2,5mm	302-0700	7mm
302-0300	3mm	302-0800	8mm
302-0350	3,5mm	302-1000	10mm
302-0400	4mm	302-1200	12mm
302-0500	5mm		
302-0550	5,5mm		

ARNDT

Σετ μίνι allen **NEO**

0,71mm - 0,89mm - 1,27mm - 1,5mm - 1,59mm (1/16")
- 2mm (5/64")

• Made in Japan



Κωδικός	Τύπος
RR-S6	6 τεμαχίων

EIGHTEX

Σετ κλειδιά allen μπίλας 6 τεμαχίων

Με σφαιρική κεφαλή
2-3-4-5-6-8mm



Κωδικός
50637

FORCE**Σετ κλειδιά allen 9 τεμαχίων**

1,5-2-2,5-3-4-5-6-8-10mm



Κωδικός
5093

FORCE**Σετ κλειδιά allen 9 τεμαχίων**

Μακριά
1,5-2-2,5-3-4-5-6-8-10mm



Κωδικός
5093L

FORCE**Σετ κλειδιά allen 9 τεμαχίων**

Μπίλας μακριά
1,5-2-2,5-3-4-5-6-8-10mm



Κωδικός
5093LB

FORCE**Σετ κλειδιά allen σε ίντσες 9 τεμαχίων**

1/16" 5/64" 3/32" 1/8" 5/32" 3/16" 1/4" 5/16" 3/8"



Κωδικός
5093S

FORCE**Σετ κλειδιά allen σε ίντσες 9 τεμαχίων**

Μακριά
1/16" 5/64" 3/32" 1/8"
5/32" 3/16" 1/4" 5/16"
3/8"



Κωδικός
5093LS

FORCE**Σετ κλειδιά allen σε ίντσες 9 τεμαχίων**

Μπίλας μακριά
1/16" 5/64" 3/32" 1/8"
5/32" 3/16" 1/4" 5/16"
3/8"



Κωδικός
5093LBS

FORCE**Σετ κλειδιά allen**

1,27-1,5-2-2,5-3-4-5-6-8-10mm



Κωδικός Τύπος
5102 10 τεμαχίων

FORCE

Σετ κλειδιά allen μακριά

1,27-1,5-2-2,5-3-4-5-6-8-10mm



Κωδικός Τύπος
5102L 10 τεμαχίων

Σετ άλλεν μπίλιας μακριά

1,27-1,5-2-2,5-3-4-5-6-8-10mm



Κωδικός Τύπος
5102LB

Σετ κλειδιά allen σε ίντσες 9 τεμαχίων

Μπίλιας πολύ μακριά
1/16" 5/64" 3/32" 1/8"
5/32" 3/16" 1/4" 5/16"
3/8"



Κωδικός
308-9

Σετ κλειδιά allen 13 τεμαχίων

Πολύ μακριά
2-2,5-3-4-5-6-7-8-10
12-14-17-19mm



Κωδικός
5137XL

Σετ κλειδιά άλλεν

Μπίλιας πολύ μακριά
1,27, 1.5, 2, 2.5, 3, 4, 5, 6, 8, 10mm



Κωδικός Τύπος
5102XLB 1,27-10mm

Σετ κλειδιά allen

Μακριά χρωματιστά
1,5-2-2,5-
3-4-5-6-8-10mm



Κωδικός Τύπος
450542018 9 τεμαχίων

Σετ κλειδιά allen

Μπίλιας χρωματιστά
πολύ μακριά
1,5-2-2,5-
3-4-5-6-8-10mm



Κωδικός Τύπος
45055 9 τεμαχίων

Σετ κλειδιά torx

T9, T10, T15, T20, T25, T27, T30,
T40



Κωδικός Τύπος
450560020 8 τεμαχίων

Σετ κλειδιά Torx με τρύπα

9 τεμαχίων
Πολύ μακριά
T10-T15-T20
T25-T27-T30
T40-T45-T50



Κωδικός
6067-1050

ARNDT

Σετ κλειδιά torx μακριά

9 τεμαχίων
T10, T15, T20,
T25, T27, T30,
T40, T45, T50



Κωδικός Τύπος
5098L
5098LT

FORCE

Σετ κλειδιά torx με τρύπα πολύ μακριά

9 τεμαχίων
T10, T15, T20,
T25, T27, T30,
T40, T45, T50



Κωδικός
5098XLT

FORCE

Σετ κλειδιά torx 9 τεμαχίων

T10, T15, T20,
T25, T27, T30,
T40, T45, T50



Κωδικός Τύπος
5098
5098T

FORCE

Κλειδιά torx

Κωδικός	Ανοιγμα	Κωδικός	Ανοιγμα
600-0600	T6	600-2700	T27
600-0700	T7	600-3000	T30
600-0800	T8	600-4000	T40
600-0900	T9	600-4500	T45
600-1000	T10	600-5000	T50
600-1500	T15	600-5500	T55
600-2000	T20	600-6000	T60
600-2500	T25		

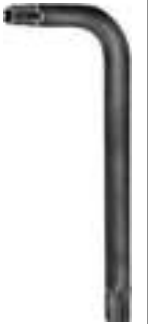

ARNDT

Κλειδιά torx με τρύπα

Κωδικός	Ανοιγμα	Κωδικός	Ανοιγμα
601-0600	TT6	601-2700	TT27
601-0700	TT7	601-3000	TT30
601-0800	TT8	601-4000	TT40
601-0900	TT9	601-4500	TT45
601-1000	TT10	601-5000	TT50
601-1500	TT15	601-5500	TT55
601-2000	TT20	601-6000	TT60
601-2500	TT25		



ARNDT

Κλειδιά γωνιακά Ribe Polydrive

Κωδικός	Ανοιγμα	Κωδικός	Ανοιγμα
6030-004	M4	6030-012	M12
6030-005	M5	6030-014	M14
6030-006	M6	6030-016	M16
6030-008	M8		
6030-010	M10		

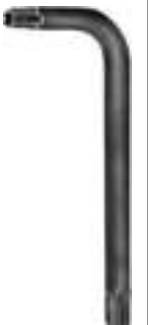

ARNDT

Κλειδιά γωνιακά πολύσφηνα XZN

Κωδικός	Ανοιγμα	Κωδικός	Ανοιγμα
200-004	M4	200-012	M12
200-005	M5	200-014	M14
200-006	M6	200-016	M16
200-008	M8		
200-010	M10		



ARNDT

Σετ κλειδιά πεντάστερα με τρύπα

TS10 - TS15 - TS20
TS25 - TS27 - TS30
TS40 - TS45 - TS50



Κωδικός
50913

FORCE



Σετ καρυδάκια 1/4" 46 τεμαχίων

Καρυδάκια : 4-4,5-5-5,5-6-7-8-9-10-11-12-13-14
 Καρυδάκια Allen : 3-4-5-6-7-8 ύψους 32 mm
 Καρυδάκια Torx : T8-T10-T15-T20-T25-T27-T30-T40
 Καρυδάκια μύτη ίσια : 4-5,5-7
 Καρυδάκια μύτη phillips : PH1-PH2-PH3
 Καρυδάκια μύτη rozidrive : PZ1-PZ2-PZ3
 Καστάνια
 Προέκταση καστάνιας 50 mm
 Προέκταση καστάνιας 100 mm
 Πολύσπαστο σταυρός
 Μανέλα T
 Κατσαβιδολαβή για καρυδάκια
 Προέκταση flexible για καρυδάκια 145 mm
 Κλειδί Allen : 1,27-1,5-2-2,5 mm

Κωδικός

2462



Σετ καρυδάκια 1/4" και μύτες 57 τεμαχίων

Καρυδάκια 4-4,5-5-5,5-6-7-8-9-10-11-12-13-14 mm
 Εξάγωνα μακριά καρυδάκια 6-7-8-10 mm
 Θηλυκά torx E4-E5-E6-E7-E8-E10
 Άλλεν 3-4-5-6-7-8 -10 mm
 Μύτες Phillips PH1-PH2-PH3
 Μύτες Pozidriv PZ1-PZ2-PZ3
 Μύτες ίσιες 4-5,5-6,5 mm
 Μύτες torx T8-T10-T15-T20-T25-T27-T30-T40
 Καστάνια με 72 δόντια
 Προκτάσεις 2"-4"
 Ολισθαίνουσα μανέλα
 Προσαρμογέα σε εξάγωνο
 Κατσαβίδι για καρυδάκια
 Άλλεν 1,27-1,5-2-2,5 mm

Κωδικός

2571



Σετ καρυδάκια 1/4" & 1/2" 94 τεμαχίων

1/4"
 Καρυδάκια 4-4,5-5-5,5-6-7-8-9-10-11-12-13-14 mm
 Μακριά καρυδάκια 6-7-8-10-11-12-13-14 mm
 Θηλυκά torx E4-E5-E6-E7-E8-E10
 Άλλεν 3-4-5-6-7-8 -10 mm
 Μύτες Phillips PH1-PH2-PH3 - Μύτες Pozidriv PZ1-PZ2-PZ3
 Μύτες ίσιες 4-5,5-6,5 mm
 Μύτες torx T8-T10-T15-T20-T25-T27-T30-T40

1/2"
 Καρυδάκια 10-11-12-13-14-15-16-17-18-19-20-21-22-24-27-30-32 mm
 Μακριά καρυδάκια 14-15-17-19-22 mm
 Καστάνιες - Προκτάσεις - Ολισθαίνουσες μανέλες
 Προσαρμογέα σε εξάγωνο - Κατσαβίδι για καρυδάκια
 Άλλεν 1,27-1,5-2-2,5 mm

Κωδικός

4941-5



Σετ καρδάκια 1/4" & 1/2" 108 τεμαχίων

Καρδάκια 4-4,5-5-5,5-6-7-8-9-10-11-12-13-14 mm
 Μακριά καρδάκια 6-7-8-10-11-12-13-14 mm
 Θηλυκά torx E4-E5-E6-E7-E8-E10
 Άλλεν 3-4-5-6-7-8 -10 mm
 Μύτες Phillips PH1-PH2-PH3 - Μύτες Pozidriv PZ1-PZ2-PZ3
 Μύτες ίσιες 4-5,5-6,5 mm
 Μύτες torx T8-T10-T15-T20-T25-T27-T30-T40
 Καρδάκια 10-11-12-13-14-15-16-17-18-19-20-21-22-24-27-30-32 mm
 Μακριά καρδάκια 14-15-17-19-22 mm
 Καστάνιες - Προκτάσεις - Ολισθαίνουσες μανέλες
 Προσαρμογέα σε εξάγωνο - Κατσαβίδι για καρδάκια
 Άλλεν 1,27-1,5-2-2,5 mm

Κωδικός

41081-5

**Σετ καρδάκια 1/4"**

4-14 mm

**Κωδικός****Τύπος**

2203-5 19 τεμαχίων

**Σετ εξάγωνα καρδάκια 1/4"**

Καρδάκια:
 4-4,5-5-5,5-6-7-8-9-10-11-12-13mm

Μύτες:

4-5,5-7mm

PH1-PH2

PZ1-PZ2

3-4-5-6-8mm

Κωδικός**Τύπος**

2292 29 τεμαχίων

**Σετ καρδάκια 3/8" 24 τεμαχίων**

6-7-8-9-10-11-12-13-14-15-16-17-18-19-20-21-22mm

**Κωδικός**

3251

**Σετ καρδάκια 1/2" 24 τεμαχίων**

10-11-12-13-14-15-16-17-18-19-20-21-22-24-27-30-32mm

**Κωδικός**

4243-5

**Σετ καρδάκια 1/2" 24 τεμαχίων**

10-32mm

**Κωδικός** **Τύπος**

4246-5 1/2"

**Σετ καρδάκια 1/2" 24 τεμαχίων**

5/16", 3/8", 7/16", 1/2", 9/16", 19/32", 5/8", 11/16", 3/4",
 25/32", 13/16", 7/8", 15/16", 1", 1 1/16", 1 1/8", 1 3/16", 1 1/4"
 Σε ίντσες

Κωδικός**Τύπος**

4246S-5

Εξάγωνα

4246S-9

(4246S) Πολύγωνα



Σετ καρδιάκια 1/4" και 1/2"

Καρδιάκια 4-32mm
 Καρδιάκια μακριά 6-22mm
 Καρδιάκια μπουζί 16-20,6mm
 Καρδιάκια E4-E24
 Καστάνιες, μανέλες, προεκτάσεις,
 πολύσπαστα 1/4" και 1/2"
 Μύτες ίσιες, Phillips, Pozidrive,
 Allen, Torx



Κωδικός Τύπος
 41082-5 108 τεμάχια

Σετ καρδιάκια 1/2" 22 τεμαχίων

Καρδιάκια 10, 11, 12, 13, 14,
 15, 16, 17, 18, 19, 22, 24, 27,
 30, 32mm
 Καστάνια
 Προεκτάσεις 125 και 250mm
 Καρδιάκια μπουζί 16 και
 20,6mm
 Σταυρός
 Adaptor 3/8"(F)x1/2"(M)



Κωδικός Τύπος
 4223 1/2"

Σετ καρδιάκια Spline 1/2" NEO

8-9-10-11-12-13-14-15-16-17-18-19-20-21-22-23-24mm
 Κατάλληλα για εξάγωνα και
 πολύγωνα (μετρικό & ίντσες)
 και Torx.



Κωδικός Τύπος
 4226Q 22 τεμάχια

Σετ εξάγωνα καρδιάκια 3/4" 14 τεμαχίων

22-24-27-30-32-36-38-41-46-50mm



Κωδικός Τύπος
 6141B-5 3/4"

Σετ καρδιάκια 3/4" 20 τεμαχίων

19-21-22-23-24-26-27-29-30-32-35-36-38-41-46-50mm



Κωδικός Τύπος
 6201B-5 εξάγωνα
 6201B πολύγωνα

Σετ πολύγωνα καρδιάκια 1" 14 τεμαχίων

36-41-46-50-55-60-65-70-75-80mm





Κωδικός
 8141

Σετ κοντά καρδιάκια ¼"

13 τεμάχια. Σε λάμα στήριξης
4-4,5-5-5,5-6-7-8-9-10-11-12-13-14mm





Κωδικός	Τύπος
2133-5	 Εξάγωνα
2133	 Πολύγωνα

**Σετ μακριά καρδιάκια ¼"**

11 τεμάχια. Σε λάμα στήριξης
4, 5, 6, 7, 8, 9, 10, 11, 12, 13, 14mm





Κωδικός	Τύπος
21115	 Εξάγωνα
21115-9	 Πολύγωνα

**Σετ κοντά καρδιάκια ½"**

12 τεμάχια. Σε θήκη στήριξης
10, 12, 13, 14, 15, 16, 17, 18, 19, 21, 22, 24mm





Κωδικός	Τύπος
4125	 Εξάγωνα
4125-9	 Πολύγωνα

**Σετ μακριά καρδιάκια ½"**

9 τεμάχια. Σε λάμα στήριξης
10, 12, 13, 14, 17, 19, 21, 22, 24mm



Κωδικός	Τύπος
40911	 Εξάγωνα
40911-9	 Πολύγωνα

**Σετ 12 καρδιάκια Spline ⅜" ^{NEO}**

8-10-11-12-13-14-15-16-17-18-19-22mm
Κατάλληλα για εξάγωνα και πολύγωνα (μετρικό & ίντσες) και Torx.



Κωδικός	Τύπος
3122Q	8-22mm

**Σετ 12 καρδιάκια Spline ½" ^{NEO}**

10-11-12-13-14-15-16-17-19-21-22-24mm
Κατάλληλα για εξάγωνα και πολύγωνα (μετρικό & ίντσες) και Torx.



Κωδικός	Τύπος
4124Q	10-24mm

**Βάσεις για καρδιάκια**



Κωδικός	Τύπος	Θέσεις	Μήκος
819212	¼"	12	200mm
819230	¼"	30	560mm
819409	½"	9	260mm
819420	½"	20	560mm

**Εκθετήριο με καρδιάκια 163 τεμαχίων**

Κωδικός	Τύπος
41631S	½"



Σετ καρυδάκια 1/4" - 1/2" και εργαλεία

Σετ καρυδάκια 1/4" (4-13mm)
 Σετ καρυδάκια 1/2" (8-32mm)
 Καρυδ. μακριά 1/2" (22-32mm)
 Καρυδ. μπουζί 1/2" (16-20,6mm)
 Σετ μύτες 
 Καλέμι, πόντα, μυτοσίμπιδο,
 πένσα, τσιμπίδα, σφυρί,
 Κατσαβίδια μακριά 
 Κατσαβίδια κοντά 
 Σετ γερμανοπολύγωνα 6-22mm



Κωδικός **Τύπος**
 4911 91 τεμάχια

Σετ καρυδάκια 1/4" & 1/2" και εργαλεία 77 τεμαχίων

Περιέχει μίνι φακό led κλιπ, 9 γερμανοπολύγωνα 8-19mm,
 πένσα, μυτοσίμπιδο, τσιμπίδα υδραυλικών,
 μαχαιράκι με σπαστές λάμες, τέσσερ συνεχείας,
 σετ καρυδάκια 1/4" 4 - 12mm,
 σετ καρυδάκια 1/2" 10 - 24mm και δύο μπουζόκλειδα,
 σετ κλειδιά άλλεν 1,27 - 10mm, πριόνι,
 σφυρί 300gr, μύτες κατσαβιδιού ίσιες - Phillips - Pozidrive
 και μαγνητικό οδηγό κατσαβίδι



Κωδικός
 4771

Σετ καρυδάκια 1/4" 3/8" & 1/2" και εργαλεία 142 τεμαχίων

Μύτες 1/4": Phillips, Pozidrive, Ίσιες μύτες, Allen, Torx
 Εξάγωνα καρυδάκια 1/4": 4-10mm, Θηλυκά torx E4-E8
 Καρυδάκια πολύγωνα 3/8": 6-22mm
 Εξάγωνα καρυδάκια 1/2": 8-32mm, Θηλυκά torx 1/2": E10-E20
 Μπουζόκλειδα 1/2": 16-20,6mm
 Γερμανοπολύγωνα 6-24mm
 Πολύγωνα κλειδιά: 8X10-10X12-11X13-12X14-17X19
 Κλειδιά άλλεν: 2,5-14mm
 Σφυρί 300 γραμμαρίων, Πένσα 180 χιλιοστών
 Σκύλα (grip) 250 χιλιοστών, Κοντό κατσαβίδι Phillips PH1
 Κατσαβίδι Phillips PH2, Κατσαβίδι κρούσης Phillips PH2
 Κοντό κατσαβίδι ίσιο 5,5mm, Κατσαβίδι ίσιο 6,5mm
 Κατσαβίδι κρούσης ίσιο 6,5mm



Κωδικός
 41421



Σετ εργαλεία 34 τεμαχίων

Περιέχει μίνι φακό led κλιπ, 9 γερμανικά κλειδιά 6-17mm, πένσα, μυτοσίμπιδο, τσιμπίδα υδραυλικών, γαλλικό κλειδί, ψαλίδι, μετροταινία, πριόνι, σφυρί 300gr, 5 κατσαβίδια ίσια - 3 κατσαβίδια Phillips, σετ κλειδιά άλλων

Κωδικός

5341



Σετ καρδιάκια Allen 1/2" 10 τεμαχίων

4-5-6-7-8-10-12-14-17-19mm



Κωδικός

4111

FORCE

Σετ μακριά καρδιάκια allen 1/2"

5-6-7-8-10-12-14-17mm. Μήκος: 110mm



Κωδικός Τύπος

4092 8 τεμαχίων

FORCE

Σετ καρδιάκια Allen ίντσας 1/2" 10 τεμαχίων

5/32"-3/16"-7/32"-1/4"-5/16"-3/8"-1/2"-9/16"-5/8"-3/4"



Κωδικός

4111S

FORCE

Σετ καρδιάκια Torx 1/2" 9 τεμαχίων

T20-T25-T27-T30-T40-T45-T50-T55-T60



Κωδικός

4102

FORCE

Σετ Torx καρδιάκια 1/2" 16 τεμαχίων

T30-T40-T45-T50-T55-T60-T70
E10-E11-E12-E14-E16-E18-E20-E22-E24

Κωδικός

4171

FORCE

Σετ Torx θηλυκά καρδιάκια 1/2" 9 τεμαχίων

E10-E11-E12-E14-E16-E18-E20-E22-E24



Κωδικός

4093

FORCE

Σετ πολύσφηνα καρδιάκια 1/2" 8 τεμαχίων

M5 - M16mm



Κωδικός

40811

FORCE

Σετ καρδιάκια 21 τεμαχίων σε κασετίνα

8-32mm



Κωδικός Τύπος

4212 1/2"

FORCE

Καστάνια 1/4" με 24 δόντια

Κωδικός Μήκος
80222 155mm

**Καστάνια 1/4" με 72 δόντια**

Κωδικός Μήκος
80229 115mm

**Καστάνια 3/8" με 24 δόντια**

Κωδικός Μήκος
80232 275mm

**Καστάνια 3/8" με 72 δόντια**

Κωδικός Μήκος
80239 195mm

**Καστάνια 1/2" με 24 δόντια**

Κωδικός Μήκος
80242 270mm

**Καστάνια 1/2" με 72 δόντια**

Κωδικός Μήκος
80249 245mm

**Καστάνια σπαστή 1/2"**

72 δόντια



Κωδικός Μήκος
802423 312mm

**Καστάνια 3/4" με 72 δόντια**

Κωδικός Μήκος
8026505 505mm

**Καστάνια διαμπερής**

Κωδικός Τύπος
802412 1/2"

**Σετ διαμπερής καστάνια και
ρακορόκλειδο**

Κωδικός Τύπος
21-214000-9 3/8" 250mm

**Βαθμιδωτό κλειδί με καστάνια
και 2 ρακορόκλειδα**

Σετ 3 τεμαχίων



Κωδικός Τύπος
4031 1/2"

**Ανταλλακτικό
βαθμιδωτό κλειδί**

1,5x8,9mm
3/8" 7/16" 15/32" 1/2" 35/64" 3/4"
27/32" 7/8"



Κωδικός Τύπος
68901 1/2"

**Ανταλλακτικό
βαθμιδωτό κλειδί**

3/8" 1/2" 3/4" 1"



Κωδικός Τύπος
68902 1/2"

**Καρέ σύνδεσης με
καρυδάκια**

Κωδικός Τύπος
802412D 1/2"

**Ανταλλακτικό καρέ
για μανέλες 1/2"**

Κωδικός
8014380-P



Μανέλα γωνία 1/2"

Κωδικός Τύπος
8154260 260mm

**Ολισθαίνουσα μανέλα μπάρα T 1/4"**

Κωδικός Μήκος
8032115 115mm

**Ολισθαίνουσα μανέλα μπάρα T 3/8"**

Κωδικός Μήκος
8033165 165mm

**Ολισθαίνουσα μανέλα μπάρα T 1/2"**

Κωδικός Μήκος
8034250 250mm

**Ολισθαίνουσα μανέλα μπάρα T 3/4"**

Κωδικός Μήκος
8036450 450mm
8036500 500mm

**Ολισθαίνουσα μανέλα μπάρα T 1"**

Κωδικός Μήκος
8038550 550mm

**Αρθρωτές μανέλες 1/2" μακριές**

Κωδικός Μήκος
8014380 380mm
8014600 600mm

**Προεκτάσεις κασάνιας 1/4"**

Κωδικός Μήκος
8042050 50mm
8042075 75mm
8042100 100mm
8042150 150mm

**Προεκτάσεις κασάνιας 1/4" ανοικτής γωνίας NEO**

Κωδικός Τύπος
8042050w 50mm
8042075w 75mm
8042100w 100mm
8042150w 150mm

**Προεκτάσεις κασάνιας 3/8"**

Κωδικός Μήκος Κωδικός Μήκος
8043075 75mm 8043150 150mm
8043100 100mm 8043200 200mm
8043125 125mm

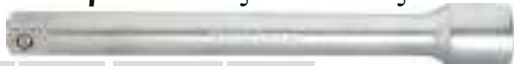
**Προεκτάσεις κασάνιας 3/8" ανοικτής γωνίας**

Κωδικός Μήκος
8043075W 75mm
8043150W 150mm
8043225W 225mm

**Προεκτάσεις κασάνιας 1/2"**

Κωδικός Μήκος
8044050 50mm
8044075 75mm
8044125 125mm
8044250 250mm

**Προεκτάσεις κασάνιας 1/2" ανοικτής γωνίας**

Κωδικός Μήκος Κωδικός Μήκος
8044050W 50mm 8044125W 125mm
8044075W 75mm 8044200W 200mm

**Προεκτάσεις κασάνιας 3/4"**

Κωδικός Μήκος
8046125 125mm
8046200 200mm
8046400 400mm



Προεκτάσεις καστανίας 1"



Κωδικός Τύπος
8048200 200mm
8048400 400mm



Προέκταση βιδολόγων για καρυδάκια 1/4"

με εξάγωνη υποδοχή 1/4"



Κωδικός Μήκος
80922175 175mm



Εύκαμπτη προέκταση για καρυδάκια 1/4"



Κωδικός Τύπος
8111 150mm
8112 175mm



Σετ 3 αντάπτορες βιδολόγου για καρυδάκια



Κωδικός Τύπος
22-257000-9 1/4" - 3/8" - 1/2"



Κατσαβίδι για καρυδάκια 1/4" κοντό



Κωδικός
8142



Κατσαβίδι για καρυδάκια 1/4"

Με υποδοχή για υποβοήθηση



Κωδικός
8143



Σπαστό



Κωδικός Τύπος
80531 3/8"
80541 1/2"
80561 3/4"



Αντάπτορας για μύτες 1/4"



Κωδικός
81022



Συστολές μανέλας



Κωδικός	Τύπος	Κωδικός	Τύπος
80923	1/4"Fx3/8"M	80946	1/2"Fx3/4"M
80932	3/8"Fx1/4"M	80964	3/4"Fx1/2"M
80934	3/8"Fx1/2"M	80968	3/4"Fx1"M
80942	1/2"Fx1/4"M	80986	1"Fx3/4"M
80943	1/2"Fx3/8"M		



Αντάπτορες για εξάγωνες μύτες σε καστανία 1/2"

Μήκος 38mm



Κωδικός Τύπος
81042 1/4"
81045 5/16"
81047 10mm



Καρυδάκι 1/2" για μπεκ Diesel



Κωδικός Τύπος
12741-21-210 21mm



Πλαστικές καρτέλες για stand



Κωδικός Τύπος
8162 Για καρυδάκια 1/4"
8163 Για καρυδάκια 3/8"
8164 Για καρυδάκια 1/2"

Καρυδάκια εξάγωνα 1/4"



Κωδικός	Τύπος	Κωδικός	Τύπος
52505	5	52510	10
525055	5,5	52511	11
52506	6	52512	12
52507	7	52513	13
52508	8	52514	14
52509	9		



Καρυδάκια πολύγωνα 1/4"



Κωδικός	Τύπος
5291.2	1/2"
5291.4	1/4"
5293.8	3/8"
5295.16	5/16"
5297.16	7/16"
5299.16	9/16"



Καρυδάκια εξάγωνα 1/4" σε ίντσες



Κωδικός	Τύπος
5251.4	1/4"
5255.16	5/16"
5253.8	3/8"
5257.16	7/16"



Καρυδάκια 1/4" εξάγωνα μακριά

Κωδικός	Τύπος	Κωδικός	Τύπος	Κωδικός	Τύπος
5255005	5	5255008	8	5255012	12
52550055	5,5	5255009	9	5255013	13
5255006	6	5255010	10	5255014	14
5255007	7	5255011	11		



Καρυδάκια πολύγωνα 1/4" μακριά



Κωδικός	Τύπος	Κωδικός	Τύπος
5295005	5	5295010	10
52950055	5,5	5295011	11
5295006	6	5295012	12
5295007	7	5295013	13
5295008	8	5295014	14
5295009	9		



Καρυδάκια 1/4" surface drive μακριά



Κωδικός	Τύπος	Κωδικός	Τύπος
5275005	5	5275010	10
52750055	5,5	5275011	11
5275006	6	5275012	12
5275007	7	5275013	13
5275008	8	5275014	14
5275009	9		



Καρυδάκια εξάγωνα 3/8"



Κωδικός	Τύπος	Κωδικός	Τύπος	Κωδικός	Τύπος
53506	6mm	53513	13mm	53520	20mm
53507	7mm	53514	14mm	53521	21mm
53508	8mm	53515	15mm	53522	22mm
53509	9mm	53516	16mm	53523	23mm
53510	10mm	53517	17mm	53524	24mm
53511	11mm	53518	18mm		
53512	12mm	53519	19mm		



Καρυδάκια πολύγωνα 3/8"



Κωδικός	Τύπος	Κωδικός	Τύπος
5391.4	1/4"	5399.16	9/16"
5395.16	5/16"	5395.8	5/8"
5393.8	3/8"	5393.4	3/4"
5397.16	7/16"		
5391.2	1/2"		



Καρυδάκια εξάγωνα μακριά 3/8"



Κωδικός	Τύπος	Κωδικός	Τύπος
5356306	06mm	5356316	16mm
5356307	07mm	5356317	17mm
5356308	08mm	5356318	18mm
5356309	09mm	5356319	19mm
5356310	10mm	5356320	20mm
5356311	11mm	5356321	21mm
5356312	12mm	5356322	22mm
5356313	13mm	5356323	23mm
5356314	14mm	5356324	24mm
5356315	15mm		



Καρυδάκια μακριά εξάγωνα 1/2"



Κωδικός	Τύπος	Κωδικός	Τύπος
5457708	8mm	5457721	21mm
5457710	10mm	5457722	22mm
545777.16	7/16"	5457724	24mm
5457712	12mm	5457725	25mm
5457713	13mm	5457726	26mm
5457715	15mm	5457727	27mm
5457716	16mm	5457728	28mm
5457717	17mm	5457729	29mm
5457718	18mm	5457730	30mm
5457719	19mm	5457732	32mm



Καρυδάκια εξάγωνα 1/2"

Κωδικός	Τύπος	Κωδικός	Τύπος	Κωδικός	Τύπος	Κωδικός	Τύπος
54507	7mm	54515	15mm	54523	23mm	54532	32mm
54508	8mm	54516	16mm	54524	24mm	54533	33mm
54509	9mm	54517	17mm	54525	25mm	54534	34mm
54510	10mm	54518	18mm	54526	26mm	54535	35mm
54511	11mm	54519	19mm	54527	27mm	54536	36mm
54512	12mm	54520	20mm	54528	28mm		
54513	13mm	54521	21mm	54529	29mm		
54514	14mm	54522	22mm	54530	30mm		



Καρυδάκια πολύγωνα 1/2"

Κωδικός	Τύπος	Κωδικός	Τύπος	Κωδικός	Τύπος	Κωδικός	Τύπος
54908	8mm	54920	20mm	54933	33mm	5491.4	1/4"
54909	9mm	54921	21mm	54934	34mm	54913.16	13/16"
54910	10mm	54922	22mm	54935	35mm	5495.16	5/16"
54911	11mm	54923	23mm	54936	36mm	5497.8	7/8"
54912	12mm	54924	24mm			5493.8	3/8"
54913	13mm	54925	25mm			54915.16	15/16"
54914	14mm	54926	26mm			5497.16	7/16"
54915	15mm	54927	27mm			5491.0	1"
54916	16mm	54928	28mm			5491.2	1/2"
54917	17mm	54929	29mm			5491.1.16	1 1/16"
54918	18mm	54930	30mm			5499.16	9/16"
54919	19mm	54932	32mm			5495.8	5/8"
						5491.3.16	1 3/16"
						54919.32	19/32"
						5491.1.4	1 1/4"
						54911.16	11/16"
						5493.4	3/4"



Καρυδάκια εξάγωνα 1/2" σε ίντσες

Κωδικός	Τύπος	Κωδικός	Τύπος	Κωδικός	Τύπος	Κωδικός	Τύπος
5451.4	1/4"	5451.2	1/2"	54525.32	25/32"	5451.1.16	1 1/16"
5455.16	5/16"	5459.16	9/16"	54513.16	13/16"	5451.1.8	1 1/8"
5453.8	3/8"	5455.8	5/8"	5457.8	7/8"	5451.3.16	1 3/16"
5457.16	7/16"	54511.16	11/16"	54515.16	15/16"	5451.1.4	1 1/4"
54515.32	15/32"	5453.4	3/4"	5451.0	1		



Καρυδάκια πολύγωνα 1/2" μακριά

Κωδικός	Τύπος	Κωδικός	Τύπος	Κωδικός	Τύπος	Κωδικός	Τύπος
5497708	8mm	5497714	14mm	5497720	20mm	5497726	26mm
5497709	9mm	5497715	15mm	5497721	21mm	5497727	27mm
5497710	10mm	5497716	16mm	5497722	22mm	5497728	28mm
5497711	11mm	5497717	17mm	5497723	23mm	5497729	29mm
5497712	12mm	5497718	18mm	5497724	24mm	5497730	30mm
5497713	13mm	5497719	19mm	5497725	25mm	5497732	32mm



Καρυδάκια κοντά εξάγωνα 3/4"

Κωδικός	Τύπος	Κωδικός	Τύπος	Κωδικός	Τύπος	Κωδικός	Τύπος
56517	17mm	56526	26mm	56535	35mm	56544	44mm
56518	18mm	56527	27mm	56536	36mm	56545	45mm
56519	19mm	56528	28mm	56537	37mm	56546	46mm
56520	20mm	56529	29mm	56538	38mm	56550	50mm
56521	21mm	56530	30mm	56539	39mm	56555	55mm
56522	22mm	56531	31mm	56540	40mm	56560	60mm
56523	23mm	56532	32mm	56541	41mm	56565	65mm
56524	24mm	56533	33mm	56542	42mm		
56525	25mm	56534	34mm	56543	43mm		



Καρυδάκια κοντά πολύγωνα 3/4"

Κωδικός	Τύπος	Κωδικός	Τύπος	Κωδικός	Τύπος	Κωδικός	Τύπος
56917	17mm	56922	22mm	56933	33mm	56946	46mm
56918	18mm	56924	24mm	56934	34mm	56950	50mm
56919	19mm	56927	27mm	56935	35mm	56955	55mm
56920	20mm	56930	30mm	56936	36mm	56960	60mm
56921	21mm	56932	32mm	56941	41mm	56965	65mm



Καρυδάκια μπουζί 1/2"



Κωδικός	Τύπος	Κωδικός	Τύπος
807414M	14mm	807420.6	20,6mm
807416M	16mm	807420.6M	20,6mm
807418M	18mm		



Καρυδάκια μπουζί με λάστιχο 3/8"



Κωδικός	Τύπος
807316	16mm
807318	18mm
807320.6	20,6mm



Εύκαμπτα καρυδάκια για μπουζί με καρέ 3/8"

μήκος 95 χιλιοστά



Κωδικός	Τύπος
807316BM	16mm



Ειδικά καρυδάκια για μπουζί με καρέ 3/8"

μήκος 250 χιλιοστά



Κωδικός	Τύπος
807325014M	14mm
807325016M	16mm



Καρυδάκια μπουζί Ταφ με υποδοχή 3/8"

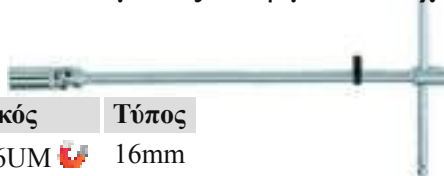

Κωδικός	Τύπος
807330016UM	16mm
807330020.6UM	20,6mm



Καρδάκια Allen ¼"**Κωδικός Τύπος**

3243203	3X32
3243204	4X32
3243205	5X32
3243206	6X32
3243207	7X32
3243208	8X32
3243210	10X32

FORCE**Καρδάκια Allen ½"****Κωδικός Τύπος Κωδικός Τύπος**

34405504	4X55	34405510	10X55
34405505	5X55	34405511	11X55
34405506	6X55	34405512	12X55
34405507	7X55	34406514	14X65
34405508	8X55	34407017	17X70
34405509	9X55	34407019	19X70

FORCE**Καρδάκια Allen ½" μήκος 100mm****Κωδικός Τύπος Κωδικός Τύπος**

34410004	4X100	34410010	10X100
34410005	5X100	34410011	11X100
34410006	6X100	34410012	12X100
34410007	7X100	34410013	13X100
34410008	8X100	34410014	14X100
34410009	9X100		

FORCE**Καρδάκια Allen ½" μήκος 140mm****Κωδικός Τύπος**

34414006	6X140
34414008	8X140
34414010	10X140
34414012	12X140
34414014	14X140

FORCE**Καρδάκια ¾" Allen****Κωδικός Τύπος**

36408014	14X80
36408017	17X80
36408019	19X80
36408022	22X80

FORCE**Καρδάκι μακρύ άλλεν 5mm σφαιρικό ½"****Κωδικός Μήκος**

34524005	240mm
----------	-------

FORCE**Καρδάκι ¼" Torx****Κωδικός Τύπος**

3263208	T8X32
3263209	T9X32
3263210	T10X32
3263215	T15X32
3263220	T20X32
3263225	T25X32
3263230	T30X32
3263240	T40X32

FORCE**Καρδάκια Torx ¼" με τρύπα****Κωδικός Τύπος**

3273208	TT8X32
3273210	TT10X32
3273215	TT15X32
3273220	TT20X32
3273225	TT25X32
3273227	TT27X32
3273230	TT30X32

FORCE

Καρυδάκια Torx 1/2"

Κωδικός	Τύπος
34605520	T20X55
34605525	T25X55
34605527	T27X55
34605530	T30X55
34605540	T40X55
34605545	T45X55
34605550	T50X55
34605555	T55X55
34605560	T60X55
34605570	T70X55
34607080	T80X70



Καρυδάκια Torx 1/2" μακριά

Κωδικός	Τύπος
34610020	T20X100
34610025	T25X100
34610027	T27X100
34610030	T30X100
34610035	T35X100
34610040	T40X100
34610045	T45X100
34610050	T50X100
34610055	T55X100
34610060	T60X100
34610070	T70X100
34610080	T80X100



Καρυδάκια torx 3/4"

μήκος 80 χιλιοστά

Κωδικός	Τύπος
36608060	T60
36608070	T70
36608080	T80
36608090	T90
366080100	T100



Καρυδάκια torx θηλυκά 1/4"



Κωδικός	Τύπος	Κωδικός	Τύπος
52604	E4	52610	E10
52605	E5	52611	E11
52606	E6	52612	E12
52607	E7	52614	E14
52608	E8	52616	E16

Καρυδάκια torx θηλυκά μακριά 1/4"



Κωδικός	Τύπος	Κωδικός	Τύπος
5265004	E4	5265010	E10
5265005	E5	5265011	E11
5265006	E6	5265012	E12
5265007	E7	5265014	E14
5265008	E8	5265016	E16

Καρυδάκια torx θηλυκά 1/2"



Κωδικός	Τύπος	Κωδικός	Τύπος
54608	E8	54618	E18
54610	E10	54620	E20
54611	E11	54622	E22
54612	E12	54624	E24
54614	E14		
54616	E16		

Καρυδάκια θηλυκά torx μακριά 1/2"

Μήκος 77mm



Κωδικός	Τύπος	Κωδικός	Τύπος
5467708	E8	5467718	E18
5467710	E10	5467720	E20
5467712	E12	5467722	E22
5467714	E14	5467724	E24
5467716	E16		

Καρδιάκια πολύσφηνα 1/2"

Κωδικός Τύπος

34805505 5X55
34805506 6X55
34805508 8X55
34805509 9X55
34805510 10X55
34805512 12X55
34805514 14X55
34805516 16X55



Καρδιάκια πολύσφηνα 1/2" μακριά

Κωδικός Τύπος

34810005 5X100
34810006 6X100
34810008 8X100
34810009 9X100
34810010 10X100
34810012 12X100
34810014 14X100
34810016 16X100



Καρδιάκια Ribe (Polydrive) 1/2"

Κωδικός Τύπος

34910005 M5X100
34910006 M6X100
34910007 M7X100
34910008 M8X100
34910009 M9X100
34910010 M10X100
34910012 M12X100
34910013 M13X100
34910014 M14X100
34910016 M16X100



Καρδιάκια πολύσφηνο μακριά 1/2"

Κωδικός Τύπος Μήκος

34812009 M9 120mm
34814010 M10 140mm



Καρδιάκια Ribe (Polydrive) με σύνδεση 1/2"

Μήκος 140mm



Κωδικός Τύπος

34914008 M8
34914009 M9
34914010 M10
34914010V M10



Καρδιάκι πολύσφηνο με τρύπα καρέ 1/2"



Κωδικός Τύπος

34805516T M16T



Καρδιάκια πολύσφηνο με τρύπα καρέ 3/4"

Μήκος 80mm



Κωδικός Τύπος

36808016T M16T
36808018T M18T



Καρδιάκια Ribe (Polydrive) 1/2"

Αρσενικά με τρύπα

Μήκος 63mm



Κωδικός Τύπος

34906308T M8
34906309T M9
34906312T M12



Μίνι αερόκλειδο 1/2"

- ο Καρέ 1/2"
- ο Μήκος 109mm
- ο Βάρος 1300gr
- ο Μέγ. ροπή 1247Nm
- ο Στροφές 9000rpm
- ο Εισαγωγή 1/4"
- ο Κατανάλωση αέρα 135 l/min
- ο Πίεση λειτουργίας 6,2bar



Κωδικός Τύπος

825411 1/2"



Αερόκλειδο με διπλό σφυρί 1/2"

- ο Καρέ 1/2"
- ο Μήκος 180mm
- ο Βάρος 2560gr
- ο Μέγ. ροπή 1566Nm
- ο Στροφές 8000rpm
- ο Εισαγωγή 1/4"
- ο Κατανάλωση αέρα 119 l/min
- ο Πίεση λειτουργίας 6,2bar



Κωδικός Τύπος

82541 1/2"



Αερόκλειδο με διπλό σφυρί 1/2"

- ο Καρέ 1/2"
- ο Μήκος 171mm
- ο Βάρος 1950gr
- ο Μέγ. ροπή 1695Nm
- ο Στροφές 8000rpm
- ο Εισαγωγή 1/4"
- ο Κατανάλωση αέρα 113 l/min
- ο Πίεση λειτουργίας 6,2bar



Κωδικός Τύπος

82549 1/2"



Αερόκλειδο με διπλό σφυρί 3/4"

- ο Καρέ 3/4"
- ο Μήκος 234mm
- ο Βάρος 4550gr
- ο Μέγ. ροπή 1673Nm
- ο Στροφές 6500rpm
- ο Εισαγωγή 1/4"
- ο Κατανάλωση αέρα 198 l/min
- ο Πίεση λειτουργίας 6,2bar



Κωδικός Τύπος

82563 3/4"



Αερόκλειδο με διπλό σφυρί

- ο Καρέ 1/2"
- ο Μήκος 183mm
- ο Βάρος 1900gr
- ο Μέγ. ροπή 813Nm
- ο Στροφές 7000rpm
- ο Εισαγωγή 1/4"
- ο Κατανάλωση αέρα 113 l/min
- ο Πίεση λειτουργίας 6,3bar



Κωδικός Τύπος

70000001 1/2"



Αερόκλειδο με διπλό σφυρί

- ο Καρέ 3/4"
- ο Μήκος 215mm
- ο Βάρος 3300gr
- ο Μέγ. ροπή 1898Nm
- ο Στροφές 5500rpm
- ο Εισαγωγή 3/8"
- ο Κατανάλωση αέρα 198 l/min
- ο Πίεση λειτουργίας 6,3bar



Κωδικός Τύπος

70000002 3/4"



Αεροκαστίανια

- ο Καρέ 1/2"
- ο Μήκος 250mm
- ο Βάρος 1200gr
- ο Μέγ. ροπή 100Nm
- ο Στροφές 160rpm
- ο Εισαγωγή 1/4"
- ο Κατανάλ. αέρα 198 l/min
- ο Πίεση λειτουργίας 6,2bar

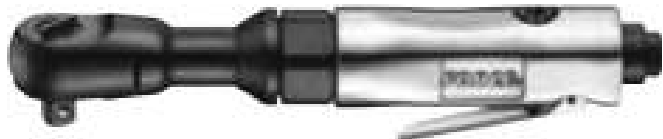

Κωδικός Τύπος

82441 1/2"



Καρυδάκια αερόκλειδου 1/2"

Κωδικός	Τύπος	Κωδικός	Τύπος	Κωδικός	Τύπος	Κωδικός	Τύπος
44510	10	44519	19	44528	28	4453.8	3/8"
44511	11	44520	20	44529	29	4451.2	1/2"
44512	12	44521	21	44530	30	4453.4	3/4"
44513	13	44522	22	44532	32	4455.8	5/8"
44514	14	44523	23	44533	33	4457.16	7/16"
44515	15	44524	24	44534	34	4459.16	9/16"
44516	16	44525	25	44536	36		
44517	17	44526	26			4457.8	7/8"
44518	18	44527	27			4451.0	1"
						4451.1.8	1 1/8"



Καρυδάκια αερόκλειδου 1/2" μακριά

Κωδικός	Τύπος	Κωδικός	Τύπος	Κωδικός	Τύπος
4458510	10	4458519	19	4458528	28
4458511	11	4458520	20	4458529	29
4458512	12	4458521	21	4458530	30
4458513	13	4458522	22	4458532	32
4458514	14	4458523	23	4458533	33
4458515	15	4458524	24	4458534	34
4458516	16	4458525	25	4458536	36
4458517	17	4458526	26		
4458518	18	4458527	27		



Καρυδάκια αέρος θηλυκά Torx 3/4"

Για μπουλόνια κυλινδροκεφαλής βαρέων οχημάτων MAN

Για μπουλόνια καλύματος στροφαλοφόρου βαρέων οχημάτων SCANIA

Κωδικός	Τύπος	Μήκος
46611018	E18	110mm
46611020	E20	110mm
46611022	E22	110mm
46611024	E24	110mm
46611028	E28	110mm



Καρυδάκια αέρος κοντά πολύγωνα μαύρα 3/4"

Κωδικός	Τύπος	Κωδικός	Τύπος
46817	17mm	46830	30mm
46818	18mm	46832	32mm
46819	19mm	46834	34mm
46820	20mm	46835	35mm
46821	21mm	46836	36mm
46822	22mm	46838	38mm
46824	24mm	46841	41mm
46827	27mm	46846	46mm



Καρυδάκια αερόκλειδου 3/4"

Κωδικός	Τύπος	Κωδικός	Τύπος	Κωδικός	Τύπος
46517	17mm	46532	32mm	46546	46mm
46518	18mm	46533	33mm	46547	47mm
46519	19mm	46534	34mm	46548	48mm
46521	21mm	46535	35mm	46550	50mm
46522	22mm	46536	36mm	46552	52mm
46523	23mm	46537	37mm	46554	54mm
46524	24mm	46538	38mm	46555	55mm
46525	25mm	46540	40mm	46557	57mm
46526	26mm	46541	41mm	46558	58mm
46527	27mm	46542	42mm	46560	60mm
46528	28mm	46543	43mm	46565	65mm
46529	29mm	46544	44mm		
46530	30mm	46545	45mm		



Καρυδάκια αερόκλειδου 3/4" μακριά

Κωδικός	Τύπος	Κωδικός	Τύπος	Κωδικός	Τύπος
46510017	17mm	46510032	32mm	46510046	46mm
46510018	18mm	46510033	33mm	46510050	50mm
46510019	19mm	46510034	34mm	46510055	55mm
46510022	22mm	46510036	36mm	46510060	60mm
46510024	24mm	46510038	38mm	46510065	65mm
46510027	27mm	46510040	40mm		
46510030	30mm	46510041	41mm		



FORCE

Καρυδάκια αερόκλειδου 1"

Κωδικός	Τύπος	Κωδικός	Τύπος	Κωδικός	Τύπος
48519	19mm	48534	34mm	48560	60mm
48522	22mm	48536	36mm	48565	65mm
48524	24mm	48538	38mm	48570	70mm
48527	27mm	48540	40mm	48575	75mm
48528	28mm	48541	41mm	48580	80mm
48530	30mm	48546	46mm	48585	85mm
48532	32mm	48550	50mm	48590	90mm
48533	33mm	48555	55mm	48595	95mm



FORCE

Καρυδάκια αερόκλειδου 1" μακριά

Κωδικός	Τύπος
48510024	24mm
48510027	27mm
48510028	28mm
48510030	30mm
48510032	32mm
48510033	33mm
48510036	36mm
48510038	38mm
48510041	41mm
48510046	46mm
48510050	50mm
48510055	55mm
48510060	60mm
48510065	65mm
48510070	70mm



FORCE

Συστολές αέρος

Κωδικός	Τύπος
80934MPB	3/8"FX1/2"M
80943MPB	1/2"FX3/8"M
80946MPB	1/2"FX3/4"M
80964MPB	3/4"FX1/2"M
80968MPB	3/4"FX1"M
80968MPP	3/4"FX1"M Pin
80986MPB	1"FX3/4"M
809812MPB	1"FX1 1/2"M
809812MPP	1"FX1 1/2"M Pin



FORCE

Καρυδάκια αέρος 3/4" σε ίντσες

Κωδικός	Τύπος
46513.16	13/16"
46515.16	15/16"
4651.0	1"
4651.3.16	1 3/16"



FORCE

Καρυδάκια εξάγωνα μπουλονόκλειδου καρέ 1/2"

Με επικάλυψη teflon για να μην πληγώνουν τις ζάντες.
Μήκος 85mm



Κωδικός	Τύπος
4458517C	17mm
4458519C	19mm
4458521C	21mm

FORCE

Καρυδάκια αερόκλειδου πολύγωνο με καρέ 1/2"

Κωδικός	Τύπος
44810	10mm
44813	13mm
44817	17mm
44818	18mm
44819	19mm
44821	21mm
44822	22mm
44824	24mm

Καρυδάκια αερόκλειδου πολύγωνο με καρέ 1/2"

Μήκος 85mm

Κωδικός	Τύπος	Κωδικός	Τύπος
4488513	13mm	4488527	27mm
4488517	17mm	4488530	30mm
4488519	19mm	4488532	32mm
4488521	21mm	4488534	34mm
4488522	22mm	4488535	35mm
4488524	24mm	4488536	36mm

Καρυδάκια αερόκλειδου τετράγωνα 3/4"

Μήκος 50mm

Κωδικός	Επαναφορά
46117	17mm
46119	19mm
46121	21mm

Καρυδάκια αερόκλειδου εξάγωνο με καρέ 1 1/2"

Κωδικός	Τύπος
4125100	100mm
4125105	105mm
4125110	110mm

Καρυδάκι εξαέρωσης αντλιών με καρέ 1/2"

Κωδικός	Τύπος	Μήκος
44322	22mm	85mm
44327	27mm	85mm
44315022	22mm	150mm

Καρυδάκι αέρος 1/2" σε ίντσες

Εξάγωνο

Κωδικός	Τύπος
4453.8	3/8"
4457.8	7/8"

Σετ καρυδάκια αέρος 1/2" 10 τεμάχια11, 12, 13,
14, 16, 17,
19, 21, 22, 24

Κωδικός	Τύπος
4109	Κοντά
4107	Μακριά

Σετ καρυδάκια για χαλασμένα παξιμάδια 1/2"

17-19-21-23-27mm

Μήκος: 50mm

Ράβδος ώθησης
παξιμαδιού

Κωδικός	Τύπος
906U2	5 τεμάχια



Καρδάκια αερόκλειδου τύπου Locknut (KM)

1/2"



Κωδικός	Επαναφορά
9TS4KM04	32mm
9TS4KM05	38mm
9TS4KM06	45mm
9TS4KM07	55mm

**Καρδάκια αερόκλειδου τύπου Locknut (KM)**

3/4"



Κωδικός	Επαναφορά
9TS6KM08	58mm
9TS6KM09	65mm
9TS6KM10	70mm
9TS6KM11	75mm
9TS6KM12	80mm
9TS6KM13	85mm
9TS6KM14	90mm

**Εξολκέας τροχαλίας μάντα**

Για VW GOLF, VENTO, PASSAT, AUDI A3, VOLVO



Κωδικός	Τύπος
67402	Για κλειδί 17mm

**Σπαστά για καρδάκια αέρος**

Κωδικός	Τύπος
80541MPB	1/2'
80561MPB	3/4'

**Προεκτάσεις αέρος 1/2"**

Κωδικός	Τύπος
8044075MPB	75mm
8044125MPB	125mm
8044250MPB	250mm

**Προεκτάσεις αέρος 3/4"**

Κωδικός	Τύπος
8046100MPB	100mm
8046175MPB	175mm
8046250MPB	250mm
8046330MPB	330mm

**Προεκτάσεις αέρος 1"**

Κωδικός	Τύπος
8048100MPB	100mm
8048175MPB	175mm
8048250MPB	250mm
8048330MPB	330mm



Διαμαντοτρώπανα OPAL

Κωδικός	Τύπος	Κωδικός	Τύπος
190000030	3X70	190000100	10X120
190000040	4X75	190000120	12X150
190000050	5X85	190000140	14X150
190000060	6X100	190000160	16X150
190000070	7X100	190000200	20X160
190000080	8X120		

**Διαμαντοτρώπανα OPAL μακριά**

Κωδικός	Τύπος	Κωδικός	Τύπος
29005150	5X150	29014200	14X200
29006150	6X150	29016200	16X200
29006200	6X200		
29008200	8X200		
29010200	10X200		
29012200	12X200		

**Διαμαντοτρώπανα TURBOKEIL**

Κωδικός	Τύπος	Κωδικός	Τύπος
258000040	4X75	258000100	10X120
258000050	5X85	258000120	12X150
258000060	6X100	258000140	14X150
258000070	7X100	258000160	16X150
258000080	8X120		

**Διαμαντοτρώπανα γρανίτη PRIMUS**

Κωδικός	Τύπος	Κωδικός	Τύπος
15404075	4X75	15414150	14X150
15405085	5X85	15416150	16X150
15406100	6X100	15418160	18X160
15408120	8X120	15420160	20X160
15410120	10X120		
15412150	12X150		

**Διαμαντοτρώπανα GOLDCRAFT**

Χωρίς κρούση. Για όλα τα υλικά.
Μεγάλη απόδοση σε μάρμαρα.

Κωδικός	Τύπος	Κωδικός	Τύπος
11903070	3X70	11910120	10X120
11904075	4X75	21910200	10X200
11905085	5X85	11912150	12X150
21905150	5X150	21912200	12X200
11906100	6X100	11914150	14X150
11965250	6,5X250	11916150	16X150
21906150	6X150		
11907100	7X100		
11908120	8X120		
21908200	8X200		

**Διαμαντοτρώπανα KEILER**

Κωδικός	Τύπος	Κωδικός	Τύπος
150000060	6X150	600000120	12X600
200000060	6X200	400000140	14X400
300000060	6X300	600000140	14X600
400000060	6X400	400000160	16X400
200000080	8X200	600000160	16X600
400000080	8X400	600000180	18X160
200000100	10X200	400000180	18X400
400000100	10X400	600000180	18X600
600000100	10X600	400000200	20X400
200000120	12X200	600000200	20X600
400000120	12X400		

**Τρωπάνια χωρίς κρούση**

Profi multicut



Κωδικός	Τύπος
0017200400100	4X120mm
0017200500100	5X120mm
0017200600100	6X120mm
0017200700100	7X120mm
0017200800100	8X120mm
0017201000100	10X120mm
0017201200100	12X120mm

**Τρωπάνια χωρίς κρούση με καρτέ 1/4"**

Profi multicut



Κωδικός	Τύπος
0027200400100	4mm
0027200500100	5mm
0027200600100	6mm
0027200800100	8mm
0027201000100	10mm



Διαμαντοτρώπανα μακριά

Profi multicut



Κωδικός	Τύπος
0072900600100	6,0X200mm
0072900650100	6,5X200mm

**Διαμαντοτρώπανα μακριά SDS Plus**

Profi multicut



Κωδικός	Τύπος
0053900650100	6,5X260mm

**Διαμαντοτρώπανα χωρίς κρούση HARDTEC**

Κωδικός	Τύπος
168000040	4X40X75mm
168000050	5X50X85mm
168000060	6X60X100mm
168000080	8X75X120mm
168000100	10X75X120mm

**Διαμαντοτρώπανα γρανιτοπλακιδίων**

Κωδικός	Τύπος	Κωδικός	Τύπος
786090050	5X67	786090150	15X80
786090060	6X67	786090200	20X70
786090080	8X80	786090250	25X70
786090100	10X80	786090300	30X70
786090120	12X80		

**Τρωπάνια SDS-Plus MS5 TURBOKEIL**

Κωδικός	Τύπος	Κωδικός	Τύπος	Κωδικός	Τύπος
253040110	4X110	253080600	8X600	253160165	16X160
253050110	5X110	253100110	10X110	253160215	16X210
253050160	5X160	253100160	10X160	253160265	16X260
253055110	5,5X110	253100210	10X210	253160450	16X450
253055160	5,5X160	253100260	10X260	253160600	16X600
253060110	6X110	253100310	10X310	253161000	16X1000
253060160	6X160	253100460	10X460	253180300	18X300
253060210	6X210	253100600	10X600	253180450	18X450
253060260	6X260	253101000	10X1000	253180600	18X600
253060360	6X360	253120160	12X160	253181000	18X1000
253060460	6X460	253120210	12X210	253200300	20X300
253065160	6,5X160	253120260	12X260	253200450	20X450
253065210	6,5X210	253120310	12X310	253200600	20X600
253065260	6,5X260	253120450	12X450	253201000	20X1000
253070110	7X110	253120600	12X600	253220250	22X250
253070160	7X160	253121000	12X1000	253220450	22X450
253080110	8X110	253140165	14X165	253220600	22X600
253080160	8X160	253140210	14X210	253221000	22X1000
253080210	8X210	253140265	14X265	253240250	24X250
253080260	8X260	253140450	14X450	253240450	24X450
253080310	8X310	253140600	14X600	253250450	25X450
253080460	8X460	253141000	14X1000		

**Διαμαντοτρώπανα γρανιτοπλακιδίων**Ξηράς κοπής
1000/3000rpm

Κωδικός	Τύπος
56752	6mm
56753	8mm
56754	10mm
56755	12mm
56756	14mm

**Τρωπάνια τετράκοπα SDS-Plus XPRO**

Κωδικός	Τύπος	Κωδικός	Τύπος
251060160	6X100X160mm	251140160	14X100X160mm
251060210	6X150X210mm	251140210	14X100X210mm
251080160	8X100X160mm	251160260	16X200X260mm
251080210	8X150X210mm	251160450	16X400X450mm
251100160	10X100X160mm	251180250	18X200X250mm
251100210	10X150X210mm	251180450	18X400X450mm
251120160	12X100X160mm	251200250	20X200X250mm
251120210	12X150X210mm	251200450	20X400X450mm

**Διαμαντοτρώπανα βιδολόγων**

KEILBIT MULTICUT

Κωδικός	Τύπος
166000030	3X75
166000040	4X85
166000050	5X95
166000060	6X100
166000080	8X120
166000100	10X120
166000120	12X151



Τρωπάνια SDS-Plus GOLDCRAFT

Χωρίς κρούση. Για όλα τα υλικά.
Μεγάλη απόδοση σε μάρμαρα.

Κωδικός Τύπος

119255001	6X160
119255002	8X160
119255003	8X210
119255004	10X160
119255005	10X260
119255006	12X165
119255007	12X260
119255008	14X260

**Τρωπάνια SDS-Plus TURBOKEIL****Κωδικός Τύπος Κωδικός Τύπος**

252116250	16X250	252124450	24X450
252118250	18X250	252125450	25X450
252120250	20X250	252128450	28X450
252116450	16X450	252130450	30X450
252118450	18X450		
252120450	20X450		
252122450	22X450		

**Τρωπάνια SDS-Plus τεράκοπα F8**

Κωδικός	Τύπος	Κωδικός	Τύπος
M81616010050	Ø5X160X100mm	M81616010012	Ø12X160X100mm
M826210150060	Ø6X210X150mm	M826210150012	Ø12X210X150mm
M836260200060	Ø6X260X200mm	M836260200120	Ø12X260X200mm
M81616010065	Ø6,5X160X100mm	M846012001000	Ø12X310X250mm
M82621015065	Ø6,5X210X150mm	M816014001000	Ø14X160X100mm
M836260200065	Ø6,5X260X200mm	M826210150014	Ø14X210X150mm
M81616010007	Ø7X160X100mm	M836260200140	Ø14X260X200mm
M81616010008	Ø8X160X100mm	M846014001000	Ø14X310X250mm
M836280210150	Ø8X210X150mm	M816016001000	Ø16X160X100mm
M836260200080	Ø8X260X200mm	M826210150016	Ø16X210X150mm
M846008001000	Ø8X310X250mm	M836016001000	Ø16X260X200mm
M81616010010	Ø10X160X100mm	M846016001000	Ø16X310X250mm
M826210150010	Ø10X210X150mm	M83625020018	Ø18X250X200mm
M836260200100	Ø10X260X200mm	M83625020020	Ø20X250X200mm
M84601000100	Ø10X310X250mm		

**Διαμαντοτρώπανα SDS MAX**

Κωδικός	Τύπος	Κωδικός	Τύπος	Κωδικός	Τύπος	Κωδικός	Τύπος
270160340	16X340	270201320	20X1320	270250920	25X920	270321320	32X1320
270160540	16X540	270220320	22X320	270251320	25X1320	270350570	35X570
270160940	16X940	270220520	22X520	270280370	28X370	270380570	38X570
270180340	18X340	270220920	22X920	270280570	28X570	270400570	40X570
270180540	18X540	270221320	22X1320	270280370	30X370	270400920	40X920
270180940	18X940	270240320	24X320	270300570	30X570	270401320	40X1320
270200320	20X320	270240520	24X520	270320370	32X370	270450570	45X570
270200520	20X520	270250320	25X320	270320570	32X570	270500570	50X570
270200920	20X920	270250520	25X520	270320920	32X920		

**Διαμαντοκεφαλές SDS-MAX****Κωδικός Τύπος**

269550550	55mm
269650550	65mm
269800550	80mm



Διαμαντοτρώπανα SDS-Plus τεράκοπα

Power-4ce



Κωδικός	Τύπος	Μήκος	Κωδικός	Τύπος	Μήκος	Κωδικός	Τύπος	Μήκος
267050110	5mm	110mm	267080260	8mm	260mm	267120310	12mm	310mm
267050160	5mm	160mm	267080310	8mm	310mm	267120400	12mm	400mm
267060110	6mm	110mm	267100160	10mm	160mm	267140160	14mm	160mm
267060160	6mm	160mm	267100210	10mm	210mm	267140200	14mm	200mm
267060210	6mm	210mm	267100260	10mm	260mm	267140250	14mm	250mm
267060260	6mm	260mm	267100310	10mm	310mm	267140300	14mm	300mm
267080110	8mm	110mm	267120160	12mm	160mm	267160200	16mm	200mm
267080160	8mm	160mm	267120210	12mm	210mm	267160250	16mm	250mm
267080210	8mm	210mm	267120260	12mm	260mm	267160300	16mm	300mm



Ποτηροκορώνες σκέτες με κρούση

για μπετόν - τούβλο

Πάσο: M16



Κωδικός	Τύπος	Κωδικός	Τύπος
710000025	Ø25	711000060	Ø60
710000030	Ø30	711000065	Ø65
710000035	Ø35	711000068	Ø68
710000040	Ø40	711000080	Ø80
710000045	Ø45	711000090	Ø90
710000050	Ø50	711000100	Ø100
711000045	Ø55		



Ποτηροκορώνες σκέτες χωρίς κρούση

για δομικά υλικά

Πάσο: M16



Κωδικός	Τύπος
719000025	Ø25X73
719000030	Ø30X73
719000035	Ø35X73
719000040	Ø40X73
719000045	Ø45X73
719000050	Ø50X73
719000060	Ø60X73
719000068	Ø68X73



Οδηγοί για ποτηροκορώνες εξάγωνοι

Πάσο: M16



Κωδικός	Τύπος
712080120	80mm
712200120	200mm
712350120	350mm
715080120	Τρυπάνι πιλότος 8X120mm



Οδηγοί για ποτηροκορώνες SDS-Plus

Πάσο: M16



Κωδικός	Τύπος
713080120	105mm
713200120	200mm
713350120	350mm
719080120	Τρυπάνι πιλότος 8X120mm



Σετ αδαμαντοκορώνες

33-53-67-73mm



Κωδικός
715033073





Τρυπάνια αέρος μαύρα DIN338



Κωδικός	Τύπος	Κωδικός	Τύπος	Κωδικός	Τύπος	Κωδικός	Τύπος
333800100	Ø1mm	333800500	Ø5mm	333800950	Ø9,5mm	333801550	Ø15,5mm
333800150	Ø1,5mm	333800520	Ø5,2mm	333801000	Ø10mm	333801600	Ø16mm
333800200	Ø2mm	333800550	Ø5,5mm	333801050	Ø10,5mm	333801650	Ø16,5mm
333800250	Ø2,5mm	333800570	Ø5,7mm	333801100	Ø11mm	333801700	Ø17mm
333800300	Ø3mm	333800580	Ø5,8mm	333801150	Ø11,5mm	333801750	Ø17,5mm
333800320	Ø3,2mm	333800600	Ø6mm	333801200	Ø12mm	333801800	Ø18mm
333800350	Ø3,5mm	333800650	Ø6,5mm	333801250	Ø12,5mm	333801850	Ø18,5mm
333800370	Ø3,7mm	333800700	Ø7mm	333801300	Ø13mm	333801900	Ø19mm
333800400	Ø4mm	333800750	Ø7,5mm	333801350	Ø13,5mm	333801950	Ø19,5mm
333800420	Ø4,2mm	333800800	Ø8mm	333801400	Ø14mm	333802000	Ø20mm
333800450	Ø4,5mm	333800850	Ø8,5mm	333801450	Ø14,5mm		
333800470	Ø4,7mm	333800900	Ø9mm	333801500	Ø15mm		

PTG

Τρυπάνια αέρος μαύρα με άξονα 13mm



Κωδικός	Τύπος	Κωδικός	Τύπος
333131350	Ø13,5mm	333131950	Ø19,5mm
333131400	Ø14mm	333132000	Ø20mm
333131450	Ø14,5mm	333132100	Ø21mm
333131500	Ø15mm	333132200	Ø22mm
333131550	Ø15,5mm	333132300	Ø23mm
333131600	Ø16mm	333132400	Ø24mm
333131650	Ø16,5mm	333132500	Ø25mm
333131700	Ø17mm	333132600	Ø26mm
333131750	Ø17,5mm	333132700	Ø27mm
333131800	Ø18mm	333132800	Ø28mm
333131850	Ø18,5mm	333132900	Ø29mm
333131900	Ø19mm	333133000	Ø30mm

PTG

Τρυπάνια μαύρα μακριά DIN340



Κωδικός	Τύπος	Κωδικός	Τύπος
334000200	Ø2mm	334000800	Ø8mm
334000250	Ø2,5mm	334000850	Ø8,5mm
334000300	Ø3mm	334000900	Ø9mm
334000350	Ø3,5mm	334000950	Ø9,5mm
334000400	Ø4mm	334001000	Ø10mm
334000450	Ø4,5mm	334001050	Ø10,5mm
334000500	Ø5mm	334001100	Ø11mm
334000550	Ø5,5mm	334001150	Ø11,5mm
334000600	Ø6mm	334001200	Ø12mm
334000650	Ø6,5mm	334001250	Ø12,5mm
334000700	Ø7mm	334001300	Ø13mm
334000750	Ø7,5mm		

PTG

Τρυπάνια με κωνικό morse DIN345



Κωδικός	Τύπος	Κωδικός	Τύπος	Κωδικός	Τύπος	Κωδικός	Τύπος
334501600	Ø16mm	334502200	Ø22mm	334502800	Ø28mm	334503400	Ø34mm
334501650	Ø16,5mm	334502250	Ø22,5mm	334502850	Ø28,5mm	334503450	Ø34,5mm
334501700	Ø17mm	334502300	Ø23mm	334502900	Ø29mm	334503500	Ø35mm
334501750	Ø17,5mm	334502350	Ø23,5mm	334502950	Ø29,5mm	334503550	Ø35,5mm
334501800	Ø18mm	334502400	Ø24mm	334503000	Ø30mm	334503600	Ø36mm
334501850	Ø18,5mm	334502450	Ø24,5mm	334503050	Ø30,5mm	334503650	Ø36,5mm
334501900	Ø19mm	334502500	Ø25mm	334503100	Ø31mm	334503700	Ø37mm
334501950	Ø19,5mm	334502550	Ø25,5mm	334503150	Ø31,5mm	334503750	Ø37,5mm
334502000	Ø20mm	334502600	Ø26mm	334503200	Ø32mm	334503800	Ø38mm
334502050	Ø20,5mm	334502650	Ø26,5mm	334503250	Ø32,5mm		
334502100	Ø21mm	334502700	Ø27mm	334503300	Ø33mm		
334502150	Ø21,5mm	334502750	Ø27,5mm	334503350	Ø33,5mm		

PTG

**Τρυπάνια αέρος HSS Sprint Master DIN338**

γρήγορα & εύκαμπτα



Κωδικός	Τύπος	Κωδικός	Τύπος
A338H0100	Ø1mm	A338H0750	Ø7,5mm
A338H0150	Ø1,5mm	A338H0800	Ø8mm
A338H0200	Ø2mm	A338H0850	Ø8,5mm
A338H0250	Ø2,5mm	A338H0900	Ø9mm
A338H0300	Ø3mm	A338H0950	Ø9,5mm
A338H0350	Ø3,5mm	A338H1000	Ø10mm
A338H0400	Ø4mm	A338H1050	Ø10,5mm
A338H0450	Ø4,5mm	A338H1100	Ø11mm
A338H0500	Ø5mm	A338H1150	Ø11,5mm
A338H0550	Ø5,5mm	A338H1200	Ø12mm
A338H0600	Ø6mm	A338H1250	Ø12,5mm
A338H0650	Ø6,5mm	A338H1300	Ø13mm
A338H0700	Ø7mm		

**Τρυπάνια κοντά με εξάγωνο καρέ 1/4"**

Κωδικός	Τύπος	Κωδικός	Τύπος
67110	1mm	67160	6mm
67115	1,5mm	67165	6,5mm
67120	2mm	67170	7mm
67125	2,5mm	67175	7,5mm
67130	3mm	67180	8mm
67135	3,5mm	67185	8,5mm
67140	4mm	67190	9mm
67145	4,5mm	67195	9,5mm
67150	5mm	67198	10mm
67155	5,5mm		

**Τρυπάνια κοβαλτίου 5% DIN338**

Κωδικός	Τύπος	Κωδικός	Τύπος	Κωδικός	Τύπος	Κωδικός	Τύπος
233850030	Ø0,3mm	233850320	Ø3,2mm	233850610	Ø6,1mm	233850900	Ø9mm
233850040	Ø0,4mm	233850330	Ø3,3mm	233850620	Ø6,2mm	233850910	Ø9,1mm
233850050	Ø0,5mm	233850340	Ø3,4mm	233850630	Ø6,3mm	233850920	Ø9,2mm
233850060	Ø0,6mm	233850350	Ø3,5mm	233850640	Ø6,4mm	233850930	Ø9,3mm
233850070	Ø0,7mm	233850360	Ø3,6mm	233850650	Ø6,5mm	233850940	Ø9,4mm
233850080	Ø0,8mm	233850370	Ø3,7mm	233850660	Ø6,6mm	233850950	Ø9,5mm
233850090	Ø0,9mm	233850380	Ø3,8mm	233850670	Ø6,7mm	233850960	Ø9,6mm
233850100	Ø1mm	233850390	Ø3,9mm	233850680	Ø6,8mm	233850970	Ø9,7mm
233850110	Ø1,1mm	233850400	Ø4mm	233850690	Ø6,9mm	233850980	Ø9,8mm
233850120	Ø1,2mm	233850410	Ø4,1mm	233850700	Ø7mm	233850990	Ø9,9mm
233850130	Ø1,3mm	233850420	Ø4,2mm	233850710	Ø7,1mm	233851000	Ø10mm
233850140	Ø1,4mm	233850430	Ø4,3mm	233850720	Ø7,2mm	233851020	Ø10,2mm
233850150	Ø1,5mm	233850440	Ø4,4mm	233850730	Ø7,3mm	233851030	Ø10,3mm
233850160	Ø1,6mm	233850450	Ø4,5mm	233850740	Ø7,4mm	233851050	Ø10,5mm
233850170	Ø1,7mm	233850460	Ø4,6mm	233850750	Ø7,5mm	233851100	Ø11mm
233850180	Ø1,8mm	233850470	Ø4,7mm	233850760	Ø7,6mm	233851150	Ø11,5mm
233850190	Ø1,9mm	233850480	Ø4,8mm	233850770	Ø7,7mm	233851200	Ø12mm
233850200	Ø2mm	233850490	Ø4,9mm	233850780	Ø7,8mm	233851220	Ø12,2mm
233850210	Ø2,1mm	233850500	Ø5mm	233850790	Ø7,9mm	233851250	Ø12,5mm
233850220	Ø2,2mm	233850510	Ø5,1mm	233850800	Ø8mm	233851300	Ø13mm
233850230	Ø2,3mm	233850520	Ø5,2mm	233850810	Ø8,1mm	233851350	Ø13,5mm
233850240	Ø2,4mm	233850530	Ø5,3mm	233850820	Ø8,2mm	233851400	Ø14mm
233850250	Ø2,5mm	233850540	Ø5,4mm	233850830	Ø8,3mm	233851450	Ø14,5mm
233850260	Ø2,6mm	233850550	Ø5,5mm	233850840	Ø8,4mm	233851500	Ø15mm
233850270	Ø2,7mm	233850560	Ø5,6mm	233850850	Ø8,5mm	233851550	Ø15,5mm
233850280	Ø2,8mm	233850570	Ø5,7mm	233850860	Ø8,6mm	233851600	Ø16mm
233850290	Ø2,9mm	233850580	Ø5,8mm	233850870	Ø8,7mm		
233850300	Ø3mm	233850590	Ø5,9mm	233850880	Ø8,8mm		
233850310	Ø3,1mm	233850600	Ø6mm	233850890	Ø8,9mm		



**Τρυπάνια κοβαλτίου 5% με άξονα 13mm**

Κωδικός	Τύπος	Κωδικός	Τύπος
253131350	Ø13,5mm	253131750	Ø17,5mm
253131400	Ø14mm	253131800	Ø18mm
253131450	Ø14,5mm	253131850	Ø18,5mm
253131500	Ø15mm	253131900	Ø19mm
253131550	Ø15,5mm	253131950	Ø19,5mm
253131600	Ø16mm	253132000	Ø20mm
253131650	Ø16,5mm		
253131700	Ø17mm		

PTG**Τρυπάνια κοβαλτίου 8% DIN338**

Κωδικός	Τύπος	Κωδικός	Τύπος
283380300	Ø3mm	283380700	Ø7mm
283380350	Ø3,5mm	283380750	Ø7,5mm
283380400	Ø4mm	283380800	Ø8mm
283380450	Ø4,5mm	283380850	Ø8,5mm
283380500	Ø5mm	283380900	Ø9mm
283380550	Ø5,5mm	283380950	Ø9,5mm
283380600	Ø6mm	283381000	Ø10mm
283380650	Ø6,5mm		

PTG**Τρυπάνια κοβαλτίου 5% μακριά DIN340**

Κωδικός	Τύπος	Κωδικός	Τύπος	Κωδικός	Τύπος	Κωδικός	Τύπος
234000200	Ø2mm	234000500	Ø5mm	234000800	Ø8mm	234001100	Ø11mm
234000250	Ø2,5mm	234000550	Ø5,5mm	234000850	Ø8,5mm	234001150	Ø11,5mm
234000300	Ø3mm	234000600	Ø6mm	234000900	Ø9mm	234001200	Ø12mm
234000350	Ø3,5mm	234000650	Ø6,5mm	234000950	Ø9,5mm	234001250	Ø12,5mm
234000400	Ø4mm	234000700	Ø7mm	234001000	Ø10mm	234001300	Ø13mm
234000450	Ø4,5mm	234000750	Ø7,5mm	234001050	Ø10,5mm		

PTG**Τρυπάνια αέρος πολύ μακριά DIN1869**

Κωδικός	Τύπος	Κωδικός	Τύπος	Κωδικός	Τύπος
228690300	Ø3X190mm	218690600	Ø6X205mm	228690850	Ø8,5X305mm
228690350	Ø3,5X210mm	228690600	Ø6X260mm	228690900	Ø9X320mm
228690400	Ø4X220mm	228690650	Ø6,5X275mm	228690950	Ø9,5X320mm
228690450	Ø4,5X235mm	228690700	Ø7X290mm	228691000	Ø10X340mm
228690500	Ø5X245mm	228690750	Ø7,5X290mm		
228690550	Ø5,5X260mm	228690800	Ø8X305mm		

PTG**Τρυπάνια καρβιδίου DIN6539**

Κωδικός	Τύπος	Κωδικός	Τύπος
296530100	Ø1	296530600	Ø6
296530150	Ø1,5	296530650	Ø6,5
296530200	Ø2	296530700	Ø7
296530250	Ø2,5	296530750	Ø7,5
296530300	Ø3	296530800	Ø8
296530350	Ø3,5	296530850	Ø8,5
296530400	Ø4	296530900	Ø9
296530450	Ø4,5	296530950	Ø9,5
296530500	Ø5	296531000	Ø10
296530550	Ø5,5		

PTG**Τρυπάνια αέρος με καρτέ 1/4"**

HSS Super



Κωδικός	Τύπος
0095200200100	2mm
0095200300100	3mm
0095200400100	4mm
0095200500100	5mm
0095200600100	6mm
0095200800100	8mm

alpen



Τρυπάνια για hardox

Κωδικός	Διατομή	Τύπος	Κωδικός	Διατομή	Τύπος
234581600	Ø16	MK2	234582700	Ø27	MK4
234581800	Ø18	MK2	234582800	Ø28	MK4
234582000	Ø20	MK3	234582900	Ø29	MK4
234582200	Ø22	MK3	234583000	Ø30	MK4
234582400	Ø24	MK3	234583100	Ø31	MK4
234582500	Ø25	MK3	234583200	Ø32	MK4
234582600	Ø26	MK3			



PTG

Κεντραδόροι τόννου

Κωδικός	Τύπος
233300200	2mm
233300250	2,5mm
233300315	3,15mm
233300400	4mm
233300500	5mm



PTG

Φρεζάκια κοβαλτίου

Κωδικός	Τύπος
3533520800	8mm
3533521000	10mm
3533521240	12,40mm
3533501650	16,50mm
3533502050	20,50mm
3533502500	25mm
3533503100	31mm



PTG

Τρυπάνια ξεπονταρίσματος DIN1897



Κωδικός	Τύπος
218980600	6X66mm Κοβαλτίου
218980800	8X79mm Κοβαλτίου
218960800	8mm Τιτανίου

PTG

Τρυπάνια αέρος ράσπα

Universal



Κωδικός	Τύπος
72106	6mm
72108	8mm

alpen

Τρυπάνια κοβαλτίου 5% DIN1412C

Uni-Fl Ιδανικά για Inox λόγω διαφορετικής ελίκωσης



Κωδικός	Τύπος	Κωδικός	Τύπος
PTG-33890300	3mm	PTG-33890700	7mm
PTG-33890350	3,5mm	PTG-33890750	7,5mm
PTG-33890400	4mm	PTG-33890800	8mm
PTG-33890450	4,5mm	PTG-33890850	8,5mm
PTG-33890500	5mm	PTG-33890900	9mm
PTG-33890550	5,5mm	PTG-33890950	9,5mm
PTG-33890600	6mm	PTG-33891000	10mm
PTG-33890650	6,5mm		

PTG

Φρεζάκια ξύλου



Κωδικός	Τύπος
2101-005	5mm
2101-006	6mm
2101-007	7mm

TopMan

Φρεζάκια ξύλου 90°



Κωδικός	Τύπος
27-173003-0	3mm
27-173004-0	4mm



Τρυπάνια για γυαλί



Κωδικός	Τύπος	Κωδικός	Τύπος
130000030	3X58	130000080	8X78
130000040	4X58	130000090	9X98
130000050	5X58	130000100	10X98
130000055	5,5X58	130000120	12X98
130000060	6X58		
130000070	7X78		



Τρυπάνια κεραμικών

Keramo Extreme



Κωδικός	Τύπος
0030000500100	5mm
0030000600100	6mm
0030000800100	8mm
0030001000100	10mm
0030001200100	12mm



Τρυπάνια κεραμικών



Κωδικός	Τύπος
151018040	4X75
151018050	5X85
151018060	6X100
151018080	8X120
151018100	10X120
151018120	12X150
151017140	14X150



Τρυπάνια ξύλου



Κωδικός	Τύπος	Κωδικός	Τύπος
18003061	3X61	18014151	14X151
18004075	4X75	18016160	16X160
18005086	5X86	18018180	18X180
18006093	6X93	18020200	20X200
18008117	8X117	18022205	22X205
18010120	10X120	18024215	24X215
18012151	12X151		



Τρυπάνια μεντεσέδων



Κωδικός	Τύπος
183000260	26X90
183000280	28X90
183000300	30X90
183000350	35X90
183000400	40X90



Τρυπάνια ξύλου μακριά



Κωδικός	Τύπος	Κωδικός	Τύπος
350060400	6X400	350120600	12X600
350060600	6X600	350140400	14X400
350080400	8X400	350140600	14X600
350080600	8X600	350160400	16X400
350100400	10X400	350160600	16X600
350100600	10X600	350180400	18X400
350120400	12X400	350200400	20X400



Τρυπάνια ξύλου μακριά ελικοειδή



Κωδικός	Τύπος
181080450	8X460
181100450	10X460
181120450	12X460
181140450	14X460
181160450	16X460



Τρυπάνια ξύλου φτερού



Κωδικός	Τύπος	Κωδικός	Τύπος
185080150	8X150	185240160	24X160
185100150	10X150	185250160	25X160
185120150	12X150	185280160	28X160
185140150	14X150	185300160	30X160
185160150	16X150	185320160	32X160
185180150	18X150	185350160	35X160
185200150	20X150	185400160	40X160
185220160	22X160		





Σετ τρυπάνια αέρος σε πλαστική θήκη

Ratioline®



Κωδικός	Τύπος
33380 7519 19	τεμάχια (1-10mm)
33380 7525 25	τεμάχια (1-13mm)

PTG

Σετ τρυπάνια κοβαλιού σε μεταλλική θήκη

Ratioline®



Κωδικός	Τύπος
43385 7519-A18 19	τεμάχια (1-10mm)
43385 7525-A18 25	τεμάχια (1-13mm)

PTG

Σετ τρυπάνια αέρος με εξάγωνο καρέ 1/4"



Κωδικός	Τύπος
67100	Ø1-Ø10 19 τεμάχια

VÖLKEL

Σετ διαμαντοτρύπανα



Κωδικός	Τύπος
190350410	Ø4-Ø10mm 5 τεμάχια

KEIL

Σετ τρυπάνια αέρος

Sprint Master TM 10
1-2-3-4-5-6-7-8-9-10mm



Κωδικός	Τύπος
008110921	10 τεμάχια

ALPEN

Σετ τρυπάνια αέρος

Sprint Master KM 19
1-1,5-2-2,5-3-3,5
4-4,5-5-5,5-6-6,5-7
7,5-8-8,5-9-9,5-10mm



Κωδικός	Τύπος
810311100	19 τεμάχια

ALPEN

Σετ διαμαντοτρύπανα με εξάγωνο καρέ 1/4"

Profi Multicut ATM 5
4-5-6-8-10mm



Κωδικός	Τύπος
001008051	5 τεμάχια

ALPEN

Φρεζάκια ZYA

Με άξονα Ø6mm



Κωδικός	Τύπος
11.3001.065	Ø6
11.3001.080	Ø8
11.3001.090	Ø10
11.3001.105	Ø12

Φρεζάκια ZYA-S

Με άξονα Ø6mm



Κωδικός	Τύπος
11.3011.050	Ø6
11.3011.075	Ø8
11.3011.085	Ø10
11.3011.100	Ø12

Φρεζάκια WRC

Με άξονα Ø6mm



Κωδικός	Τύπος
11.3021.055	Ø6
11.3021.075	Ø8
11.3021.085	Ø10
11.3021.100	Ø12

Φρεζάκια KUD

Με άξονα Ø6mm



Κωδικός	Τύπος
11.3031.055	Ø6
11.3031.060	Ø8
11.3031.070	Ø10
11.3031.080	Ø12

Φρεζάκια TRE

Με άξονα Ø6mm



Κωδικός	Τύπος
11.3041.020	Ø6
11.3041.025	Ø8
11.3041.030	Ø10
11.3041.035	Ø12

Φρεζάκια RBF

Με άξονα Ø6mm



Κωδικός	Τύπος
11.3051.030	Ø6
11.3051.035	Ø8
11.3051.040	Ø10
11.3051.050	Ø12

Φρεζάκια SPG

Με άξονα Ø6mm



Κωδικός	Τύπος
11.3061.035	Ø6
11.3061.040	Ø8
11.3061.045	Ø10
11.3061.055	Ø12

Φρεζάκια KEL

Με άξονα Ø6mm



Κωδικός	Τύπος
11.3081.020	Ø6
11.3081.025	Ø8
11.3081.035	Ø10
11.3081.045	Ø12

Φρεζάκια SKM

Με άξονα Ø6mm



Κωδικός	Τύπος
11.3091.020	Ø6
11.3091.025	Ø8
11.3091.035	Ø10
11.3091.045	Ø12

Σταντ με καρβίδια με άξονα Ø3

Κωδικός	Τύπος
11.4837U	50 τεμάχια

**Βύσματα ξύλου βιδωτά γαλβανιζέ**

BUSSOLA

**FRIULSIDER****Κωδικός** | **Τύπος**22200b61215 6X15mm
22200b81220 8X20mm
22200b10020 10X20mm**Βύσματα ξύλου ορειχάλκινα**

TO

**FRIULSIDER**

Κωδικός	Τύπος
75100005000	M5X20
75100006000	M6X23
75100008000	M8X28
75100010000	M10X32
75100012000	M12X38

Βύσματα ξύλου χτυπητά γαλβανιζέ

DCG

**FRIULSIDER****Κωδικός** | **Τύπος**22500b04000 M4
22500b05000 M5
22500b06000 M6
22500b08000 M8
22500b10000 M10**Στηρίγματα σωλήνα**

CP

χωρίς πλαστικό βύσμα

**FRIULSIDER****Κωδικός** | **Σωλήνας**50416b00002 1/2"
50416b00003 3/4"
50416b00004 1"
50416b00005 1 1/4"
50416b00006 1 1/2"**Στηρίγματα σωλήνα**

CFC

με πλαστικό βύσμα

**FRIULSIDER****Κωδικός** | **Τύπος** | **Σωλήνας**50201b10000 6X30mm Ø10
50201b12000 6X30mm Ø12
50201b14000 6X30mm Ø14
50201b16000 6X30mm Ø16
50201b18000 6X30mm Ø18
50201b20000 6X30mm Ø20**Στηρίγματα σωλήνα βαρέως τύπου**

CPI

με μόνωση

**FRIULSIDER****Κωδικός** | **Σωλήνας**50505b00003 3/4"
50505b00004 1"
50505b00005 1 1/4"
50505b00006 1 1/2"
50505b00007 2"
50502b00008 2 1/2"
50502b00009 3"**Ζυγκιά σωλήνα**

CSA

**FRIULSIDER****Κωδικός** | **Σωλήνας**50801b00002 1/2"
50801b00003 3/4"
50801b00004 1"
50801b00005 1 1/4"
50801b00006 1 1/2"
50801b00007 2"
50801b00009 2 1/2"
50801b00010 3"**Στηρίγματα σωλήνων INOX W5 (316)****Κωδικός** | **Σωλήνας** | **Πάσο**2APRI018 Ø18 M8
2APRI022 Ø22 1/2" M8
2APRI028 Ø28 3/4" M8
2APRI035 Ø35 1" M8
2APRI040 Ø40 M8
2APRI048 Ø48 1 1/2" M8
2APRI054 Ø54 M8
2APDRI060 Ø60 2" M8&M10
2APDRI070 Ø70 M8&M10
2APDRI075 Ø75 2 1/2" M8&M10
2APDRI084 Ø84 M8&M10
2APDRI090 Ø90 3" M8&M10
2APDRI100 Ø100 M8&M10
2APDRI110 Ø110 M8&M10
2APDRI150 Ø150 M8&M10**Lifial**

Στηρίγματα σωλήνων (ζυγκιά)

Κωδικός	Σωλήνας	Πάσο
2AB12	½"	M6
2AB114	1¼"	M8
2AB112	1½"	M8
2AB212	2½"	M8
2AB3	3"	M8

**Στηρίγματα σωλήνων**

Κωδικός	Σωλήνας	Πάσο
2ΑΕΡ050	½"	M8
2ΑΕΡ075	¾"	M8
2ΑΕΡ100	1"	M8
2ΑΕΡ125	1¼"	M8
2ΑΕΡ150	1½"	M8
2ΑΕΡ300	3"	M8

**Στηρίγματα σωλήνων ΒΤ με μόνωση**

Κωδικός	Σωλήνας	Πάσο
2ΑΕΡΒ8075	¾"	M8
2ΑΕΡΒ8100	1"	M8
2ΑΕΡΒ8150	1½"	M8
2ΑΕΡΒ8200	2"	M8

**Τσέρκια 10m INOX W5 (316)**

Κωδικός	Τύπος
1RFPI12	12X0,8mm
1RFPI17	17X0,8mm

**Πλαστικά βύσματα τοίχου γενικής χρήσης**

TMT



Κωδικός	Τύπος	Κωδικός	Τύπος
65000006033	6X33	65000010066	10X66
65000006046	6X46	65000012072	12X72
65000008051	8X51		

**Βύσματα τοίχου νάιλον**

TU



Κωδικός	Τύπος	Κωδικός	Τύπος
60100005025	5X25	60100010050	10X50
60100006030	6X30	60100012060	12X60
60100007035	7X35	60100014080	14X80
60100008040	8X40		

**Βύσματα τοίχου**

X1 Κατάλληλα και για μηχανόβιδες



Κωδικός	Τύπος	Κωδικός	Τύπος
60070006030	6X30	60070010050	10X50
60070006050	6X50	60070012060	12X60
60070008040	8X40		

**Βύσματα τούβλου**

TDE



Κωδικός	Τύπος
63200012070	12X70
63200014075	14X75

**Βύσματα τοίχου μακριά σκέτα**

TUP1



Κωδικός	Τύπος	Κωδικός	Τύπος
60300008080	8X80	60300016160	16X160
60300010080	10X80		
60300010110	10X100		

**Βύσματα τοίχου μακριά σκέτα**

TUP4



Κωδικός	Τύπος	Κωδικός	Τύπος
6410000808000	8x80	6410001010000	10x100
6410000810000	8x100	6410001011500	10x115
6410000812000	8x120	6410001013500	10x135
6410001008500	10x85		

**Βύσματα γυψοσανίδας νάιλον**

FX



Κωδικός	Τύπος
60036006040	6X40mm
60036008050	8X50mm
60036010060	10X60mm



**Βύσμα νάιλον χωρίς βίδα**

XP

**Κωδικός** | **Τύπος**66000006045f2 6X45mm
66000008052f2 8X52mm**FRIULSIDER****Βύσμα νάιλον με βίδα**

XP

**Κωδικός** | **Τύπος**66001006045f2 6X45mm
66001008052f2 8X52mm**FRIULSIDER****Πλαστικά βύσματα τοίχου χτυπητά**

TPP (με γαλβανιζέ βίδες)

**Κωδικός** | **Τύπος**62700b05040 5X40
62700b05050 5X50
62700b06050 6X50
62700b06060 6X60
62700b08060 8X60
62700b08080 8X80
62700b08100 8X100
62700b08120 8X120**FRIULSIDER****Βύσματα τοίχου με γαλβανιζέ βίδες**

TSS

**Κωδικός** | **Τύπος**62200b06040f2 6X50
62200b06060f2 6X60**FRIULSIDER****Βύσματα βαρέως τύπου**

TUPP

**Κωδικός** | **Τύπος**

64001b16160 16X160

FRIULSIDER**Βύσμα μακρύ με βίδα καρφωτό**

TCS

**Κωδικός** | **Τύπος**

60301b08135 8X135mm

FRIULSIDER**Βύσματα τοίχου με γαλβανιζέ βίδες**

TUP4 φρεζάτες βίδες με Torx T30

**Κωδικός** | **Τύπος**64103b08080 8X80
64103b08100 8X100
64103b08120 8X120
64103b10085 10X85
64103b10100 10X100
64103b10115 10X115
64103b10135 10X135**FRIULSIDER****Βύσματα τοίχου με ανοξείδωτες βίδες INOX A4**

TUP4 φρεζάτες βίδες με Torx T30

**Κωδικός** | **Τύπος**64103008080 8X80
64103008100 8X100
64103008120 8X120
64103010085 10X85
64103010100 10X100
64103010115 10X115
64103010135 10X135**FRIULSIDER****Θηλιές με βύσμα**

TAL

**Κωδικός** | **Τύπος**

60802b09049 9X49

FRIULSIDER**Βύσματα με εξάγωνο άξονα**

MDE

**Κωδικός** | **Τύπος**62800b00100 12X70X100X8
62800b00080 12X70X80X10
62800b00145 14X75X145X12**FRIULSIDER**

**Γάντζοι γυψοσανίδας γαλβανιζέ**

AM

**Κωδικός** | **Τύπος**

76210b05070 M5X70mm

76210b06075 M6X75mm

FRIULSIDER**Θηλιές γυψοσανίδας γαλβανιζέ**

AM

**Κωδικός** | **Τύπος**

76310b04070 M4X70mm

76310b05070 M5X70mm

FRIULSIDER**Βύσματα γυψοσανίδας πλαστικά**

TAN

**Κωδικός** | **Τύπος**

6550501503500 15X35mm

FRIULSIDER**Βύσματα γυψοσανίδας μεταλλικά**

TRZ

**Κωδικός** | **Τύπος**

75006013030 13X30mm

FRIULSIDER**Βύσματα γυψοσανίδας αρθρωτά**

TMC

**Κωδικός** | **Τύπος**

75001004038 M4X40 8X33mm

75001004045 M4X45 8X39mm

75001005045 M5X43 10X37mm

75001005058 M5X60 10X53mm

75001005071 M5X74 10X65mm

75001006045 M6X45 12X37mm

75001006058 M6X60 12X53mm

75001006071 M6X74 12X66mm

FRIULSIDER**Πλαστικά βύσματα YTONG**

TML

**Κωδικός** | **Τύπος**

62601006050 M6 10X50

62601008060 M8 12X60

62601010070 M10 14X70

FRIULSIDER**Βύσματα θερμοπρόσοψης**

FOX (Βιδώνουν με Torx T40)

**Κωδικός** | **Τύπος**

61951025050 25X50

61951025085 25X85

FRIULSIDER**Πένσα αρθρωτών βυσμάτων**

TMC tool

**Κωδικός**

49901000000

FRIULSIDER**Πένσα αρθρωτών βυσμάτων**

Για βύσματα 4-5mm

**Κωδικός**

AP-200

**Πένσα αρθρωτών βυσμάτων****Κωδικός**

AP-100 Ø4-Ø5-Ø6mm



**Βίδες ντίζες γαλβανιζέ**BFK
για χημικά βύσματα**Κωδικός** | **Τύπος**

21911b10115 M10X115mm

21911b12120 M12X120mm

21911b12160 M12X160mm

21911b16190 M16X190mm

FRIULSIDER**Πλαστικά δίχτυα χημικής αγκύρωσης**

BRP

**Κωδικός** | **Τύπος**

63300015085 15X85mm

63300015130 15X130mm

FRIULSIDER**Φυσίγγιο χημικής αγκύρωσης**

HR955

**Κωδικός** | **Τύπος**

95500000000 300ml

FRIULSIDER**Βύσματα ντίζας γαλβανιζέ χωρίς χείλος**

TAP

**Κωδικός** | **Τύπος**

75203b06000 M6 8X25

75203b08000 M8 10X30

75203b10000 M10 12X40

75203b12000 M12 15X50

75203b16000 M16 20X65

FRIULSIDER**Βύσματα ντίζας γαλβανιζέ με χείλος**

TAPCE

**Κωδικός** | **Τύπος**

75205b0800000 M8 10X30

75205b1000000 M10 12X40

75205b1200000 M12 15X50

FRIULSIDER**Βύσματα ντίζας ανοξείδωτα INOX A2**

TAP

**Κωδικός** | **Τύπος**

75204006000 8X25 M6

75204008000 10X30 M8

75204010000 12X40 M10

75204012000 15X50 M12

FRIULSIDER**Μεταλλικά βύσματα χωρίς βίδα γαλβανιζέ**

FM744 galv

**Κωδικός** | **Τύπος** | **Οπή**

74400b10040 10X40mm M6

74400b14050 14X50mm M8

74400b16060 16X60mm M10

74400b20080 20X80mm M12

74400b25100 25X100mm M16

FRIULSIDER**Μεταλλικά βύσματα χωρίς βίδα INOX**

FM744 inox

**Κωδικός** | **Τύπος** | **Οπή**

74400b12050 12X50mm M6

74400b14050 14X55mm M8

74400b16060 16X65mm M10

74400b20080 20X80mm M12

FRIULSIDER

**Μεταλλικά βύσματα κουφωμάτων**

TMF



Κωδικός	Τύπος
77202b10092	10X92 M6
77202b10112	10X112 M6

FRIULSIDER**Μεταλλικά βύσματα μπετού**

TSA



Κωδικός	Τύπος
79602b08060	8X60
79602b08080	8X80
79602b10080	10X80
79602b12100	12X100
79602b16150	16X150

FRIULSIDER**Μεταλλικά βύσματα βαρέως τύπου γαλβανιζέ**

ATS



Κωδικός	Τύπος	Οπή
79302b10080	10X80mm	M6
79302b10110	10X110mm	M6
79302b12080	12X80mm	M8
79302b12120	12X120mm	M8
79302b15100	15X100mm	M10
79302b15130	15X130mm	M10
79302b15180	15X180mm	M10
79302b18125	18X125mm	M12
79302b18150	18X150mm	M12
79302b18200	18X200mm	M12
79302b24140	24X140mm	M16
79302b24165	24X165mm	M16

FRIULSIDER**Μεταλλικά βύσματα με πάσο γαλβανιζέ**

ATS-evo B

Βαρέως τύπου



Κωδικός	Τύπος	Οπή
79402b18200	18X200mm	M12

FRIULSIDER**Μεταλλικά βύσματα με πάσο γαλβανιζέ**

WA Ελαφρού τύπου FM18000b



Τύπος	Τύπος
6X55mm	12X180mm
6X65mm	16X140mm
8X75mm	16X175mm
10X140mm	20X130mm
12X110mm	20X160mm
12X160mm	20X220mm

FRIULSIDER**Μεταλλικά βύσματα χτυπητά γαλβανιζέ**

FM753 galv DIN9362



Κωδικός	Τύπος
75320b06065	M6X65mm
75320b06085	M6X85mm
75320b08050	M8X50mm
75320b12160	M12X160mm
75320b14110	M14X110mm
75320b14150	M14X150mm
75320b14170	M14X170mm
75320b14200	M14X200mm
75320b16215	M16X215mm
75320b20170	M20X170mm
75320b20215	M20X215mm

FRIULSIDER**Μεταλλικά βύσματα χτυπητά γαλβανιζέ**

DIN9362



Τύπος	Τύπος
M8X75mm	M14X110mm
M8X90mm	M14X135mm
M8X120mm	M14X160mm
M10X90mm	M14X185mm
M10X120mm	M16X125mm
M10X140mm	M16X145mm
M10X170mm	M16X180mm
M12X110mm	M20X140mm
M12X135mm	M20X180mm
M12X160mm	M20X220mm
M12X185mm	M24X220mm
M12X215mm	M24X260mm

**Γάντζοι γαλβανιζέ**

GF



Κωδικός	Τύπος
77602b06050	M6X50mm
77602b08060	M8X60mm
77602b10073	M10X73mm
77602b12090	M12X90mm

FRIULSIDER**Βίδες θηλιές γαλβανιζέ**

FM776



Κωδικός	Τύπος
77601b06050	M6X50mm
77601b08060	M8X60mm
77601b10073	M10X73mm
77601b12090	M12X90mm

FRIULSIDER**Ευλόβιδες γωνίες γαλβανιζέ**

NFER

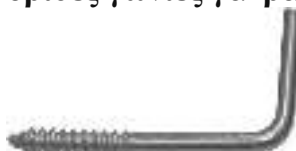

Κωδικός	Τύπος
85000b20050	20X50
85000b20060	20X60
85000b20070	20X70
85000b21080	21X80
85000b22100	22X100
85000b22100	23X100
85000b23120	23X120

FRIULSIDER**Ευλόβιδες γάντζοι γαλβανιζέ**

NFEG



Κωδικός	Τύπος
85200b18050	18X50
85200b19060	19X60
85200b19070	19X70
85200b20080	20X80
85200b21090	21X90
85200b23100	23X100
85200b23120	23X120

FRIULSIDER**Ευλόβιδες θηλιές γαλβανιζέ**

NFEO



Κωδικός	Τύπος	Κωδικός	Τύπος
85300b18050	18X50	85300b22100	22X100
85300b19060	19X60	85300b22120	22X120
85300b20080	20X80	85300b23100	23X100
85300b21090	21X90	85300b23120	23X120
85300b22080	22X80	85300b23140	23X140

FRIULSIDER**Ευλόβιδες κρίκοι γαλβανιζέ**

TUVL-P



Κωδικός	Τύπος	Οπή
85302b12120	12X120	Ø23mm
85310b12120	12X120	Ø50mm
85302b12160	12X160	Ø23mm
85310b12160	12X160	Ø50mm

FRIULSIDER**Στριφονόβιδες γαλβανιζέ**

VSS / VCS



Κωδικός	Τύπος	Κωδικός	Τύπος	Κωδικός	Τύπος
01100b06050	6X50	01000b08070	8X70	01000b10090	10X90
01100b06060	6X60	01000b08080	8X80	01000b10100	10X100
01100b06070	6X70	01000b08090	8X90	01000b10120	10X120
01100b06080	6X80	01000b08100	8X100	01000b10140	10X140
01100b06090	6X90	01000b08120	8X120	01000b10180	10X180
01100b06100	6X100	01000b08140	8X140		
01100b06110	6X110	01000b08160	8X160		
01000b08050	8X50	01000b10070	10X70		
01000b08060	8X60	01000b10080	10X80		

FRIULSIDER



Στριφώνια φρεζάτα γαλβανιζέ

FM-WOOD PRO



Κωδικός	Τύπος	Κωδικός	Τύπος	Κωδικός	Τύπος
07310d06080	6X80	07310d08120	8X120	07310d10100	10X100
07310d06100	6X100	07310d08140	8X140	07310d10140	10X140
07310d06120	6X120	07310d08160	8X160	07310d10160	10X160
07310d06140	6X140	07310d08180	8X180	07310d10200	10X200
07310d06160	6X160	07310d08200	8X200	07310d10240	10X240
07310d06180	6X180	07310d08240	8X240	07310d10260	10X260
07310d06200	6X200	07310d08260	8X260	07310d10280	10X280
07310d08080	8X80	07310d08300	8X300	07310d10300	10X300
07310d08100	8X100	07310d10080	10X80		

FRIULSIDER

Τσιμεντόβιδες γαλβανιζέ Torx T30



Διαστάσεις

7,5X72

7,5X92

7,5X112

7,5X132

7,5X152

7,5X182

7,5X202

Μπετονόβιδες εξάγωνες γαλβανιζέ

VF



Κωδικός

Τύπος

19063b06060 6,6X60

19063b06070 6,6X70

19063b06085 6,6X85

19063b06105 6,6X105

FRIULSIDER

Στριφώνια εξάγωνα γαλβανιζέ CR3+ DIN571



Πάχος→	6	8	10	Πάχος→	6	8	10
↓Μήκος↓				↓Μήκος↓			
40	✓	✓		120	✓	✓	✓
50	✓	✓	✓	140	✓	✓	✓
60	✓	✓	✓	150		✓	✓
70	✓	✓	✓	160		✓	✓
80	✓	✓	✓	180		✓	✓
90		✓	✓	200		✓	✓
100	✓	✓	✓				

**Τρυπανόβιδες Wafer (truss)**

Χάλυβας C1022



Διαστάσεις	Διαστάσεις
4,2X13	4,2X25
4,2X16	4,2X32
4,2X19	4,2X38

Τρυπανόβιδες με εξάγωνο κεφάλι

Χάλυβας C1022 με ροδέλα και φλάντζα (EPDM)

Διαστάσεις	Διαστάσεις
6,3X19	6,3X63
6,3X25	6,3X70
6,3X32	6,3X75
6,3X38	6,3X88
6,3X50	6,3X100

Τρυπανόβιδες με εξάγωνο κεφάλι χωρίς ροδέλα

Χάλυβας C1022



Διαστάσεις	Διαστάσεις
6,3X25	6,3X88
6,3X32	6,3X100
6,3X38	6,3X110
6,3X50	6,3X125
6,3X60	6,3X140
6,3X75	6,3X150
6,3X80	

Ντίζες DIN976 4,8 γαλβανιζέ 1 μέτρου

Κωδικός	Τύπος	Κωδικός	Τύπος
75M105	M5	75M118	M18
75M106	M6	75M120	M20
75M108	M8	75M122	M22
75M110	M10	75M124	M24
75M112	M12	75M127	M27
75M114	M14	75M130	M30
75M116	M16		

Παξιμάδια γαλβανιζέ DIN934 Class8 NEO

Τύπος	h ^{mm}
M5	20000
M6	10000
M8	4000
M10	2000
M12	1500
M14	1000
M16	600
M18	550
M20	450
M22	300
M24	250
M27	150
M30	120

**Παξιμάδια ασφαλείας γαλβανιζέ DIN985 Class8 NEO**

Τύπος	h ^{mm}
M5	16000
M6	8000
M8	4000
M10	2000
M12	1500
M14	1000
M16	500
M18	450
M20	350
M22	248
M24	200



Τζαμοκόφτης



Κωδικός
28-239000-0
71561



Τζαμοκόφτης επαγγελματικός

Βαρέως τύπου
*για πάχος έως 10mm



Κωδικός
28-250014-0
50000



Τζαμοκόφτης επαγγελματικός

Βαρέως τύπου
*για πάχος έως 20mm



Κωδικός
28-250000-0
71750



Βεντούζα τζαμιών διπλή

*για βάρος έως 100 κιλά



Κωδικός
63403A



Μαγνητικό πιάτο στρόγγυλο Ø150



Κωδικός
88001



Μαγνητικό πιάτο ορθογώνιο 360X160



Κωδικός
88003



Ψεκαστήρας βαρέως τύπου

Αντοχή έως 13 ph



Κωδικός Τύπος
06243 750ml



Μπετόνι συλλογής λαδιών



Κωδικός Τύπος
24115 7ℓ



Σύριγγα βαλβολινιέρα χειρός



Κωδικός Τύπος
12902 500ml



Χωνιά πλαστικά σετ 4 τεμ.

Κωδικός	Τύπος
02360	Ø50-75-100-120

**Χωνιά πλαστικά**

Κωδικός	Τύπος
02366	Ø200
02367	Ø250
02367 020	Ø250 με σίτα

**Χωνιά μεταλλικά**

Με σίτα



Κωδικός	Τύπος
02342	Ø160
02344	Ø200

**Χωνιά πλαστικά**

Με σίτα



Κωδικός	Τύπος
02372	Ø160 χωρίς ρουξούνι
02674	Ø160 με ρουξούνι
01172	Σίτα Ø58

Χωνί στραβό

Κωδικός	Τύπος
02562	Ø160 1,2λ

**Ρουξούνια**

Κωδικός	Τύπος
02640	Μεταλλικό Ø40X300mm
00241	Πλαστικό Ø45X320mm

**Πλαστικές κανάτες
ογκομέτρησης**PP Πολυπροπυλένιο
Κατάλληλα
για τρόφιμα

Κωδικός	Τύπος
07061	0,5λ
07062	1λ
07063	2λ
07071	Σετ και τα 3

**Κανάτα δοσομετρητής κλειστού
τύπου**

Κωδικός	Τύπος
07623	3λ

**Αντλία υγρών για δράπανα** NEO
2500λ/h Ø½"
3000rpm

Κωδικός	Τύπος
890.00	Ø8mm

**Μπετόνια καυσίμων**

Κωδικός	Τύπος
21131	5λ
21133	10λ
21137	20λ

**Μπετόνια νερού**

Κωδικός	Τύπος
21163	10λ
21167	20λ
21088	βρυσάκι



Ταινίες συσκευασίας διαφανείς



Κωδικός	Τύπος	h ²
5213200007	48mmX50m PPL-A θορυβώδεις	36
5213200005	48mmX60m PPL-A θορυβώδεις	36
5100300006	48mmX50m PPA-B αθόρυβες	36
5100300004	48mmX60m PPA-B αθόρυβες	36



Ταινίες συσκευασίας καφέ



Κωδικός	Τύπος	h ²
5213400005	48mmX50m PPL-A θορυβώδεις	36
5213400004	48mmX60m PPL-A θορυβώδεις	36
5100600006	48mmX50m PPA-B αθόρυβες	36
5100600004	48mmX60m PPA-B αθόρυβες	36



Χαρτοταινίες



Κωδικός	Τύπος	h ²
5013900013	19mmX41m	96
5013900012	24mmX40m	72
5013900011	30mmX45m	60
5013900010	36mmX41m	48
5013900009	48mmX41m	36



Ταινίες σήμανσης άσπρο κόκκινο



Κωδικός	Τύπος
5310000004	70mmX200m



Αυτοκόλλητες αλουμινοταινίες



Κωδικός	Τύπος
5300200000	48mmX10m



Στρετς φιλμ χειρός

Μαδρέν: 300gr



Κωδικός	Τύπος	h ²
1703700051	1,60kg 23μm Διαφανές	6
1703400005	1,60kg 23μm Μαύρο	6



Μονωτικές ταινίες PVC



Κωδικός	Τύπος
DJ-5403800004	17mm λευκή
DJ-5403800002	17mm μαύρη
DJ-5403800006	17mm γκρι
DJ-5403800000	17mm κόκκινη
DJ-5403800001	17mm κίτρινη
DJ-5303800002	48mm λευκή
DJ-5303800003	48mm μαύρη



Νυστέρι με 16 λεπίδες



Κωδικός
D-12YE

KDS

Φαλτσέτα με σπαστή λεπίδα 9mm



Κωδικός
S-11

KDS

Φαλτσέτα με σπαστή λεπίδα 9mm 30°



Κωδικός
S-18

KDS

Φαλτσέτα με 3 σπαστές λεπίδες 9mm



Κωδικός
S-14

KDS

Φαλτσέτα σουγιάς

Με τραπεζοειδή λεπίδα



Κωδικός
DBKWH-EU



Φαλτσέτα με σπαστή λεπίδα 18mm



Κωδικός
GC-401

KDS

Φαλτσέτα με σπαστή λεπίδα 18mm



Κωδικός
L-18

KDS

Φαλτσέτα με σπαστή λεπίδα 18mm

με μαύρες λεπίδες



Κωδικός
G-15

KDS

Φαλτσέτα με σπαστές λεπίδες 18mm

με ροδάκι και 3 μαύρες λεπίδες



Κωδικός
L-23

KDS

Φαλτσέτα με σπαστή λεπίδα 18mm

με ανοικτήρι κουτιών χρωμάτων και μαύρες λεπίδες



Κωδικός
L-24

KDS

Φαλτσέτα με σπαστή λεπίδα 25mm

με μαύρες λεπίδες



Κωδικός
H-13

KDS

Φαλτσέτα με σπαστή λάμα 18mm

Σώμα αλουμινίου



Κωδικός
L-33

KDS

Φαλτσέτα παπαγαλάκι

Με σπαστά ανταλλακτικά



Κωδικός
HK-11

KDS

Φαλτσέτα με 2 τραπεζοειδείς λεπίδες

Με αυτόματο κλείσιμο



Κωδικός
SA-14

KDS

Φαλτσέτα με σπαστή λεπίδα 18mm



Κωδικός
9010165BK



Αντιολισθητικές επιφάνειες κοπής

Διπλής όψης, 3 στρώσεων.
Για πάγκους εργασίας

Κωδικός	Τύπος
SSO-1000F	300x220x3mm
SMO-2000F	450x300x3mm
MMO-3900F	620x450x3mm

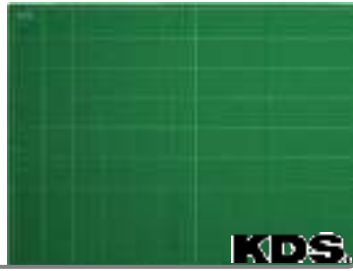
**KDS****Ανταλλακτικές λεπίδες 9mm**

Σετ 10 τεμαχίων

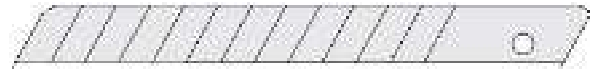

Κωδικός
SB-10 EVO

KDS**Ανταλλακτικές λεπίδες 9mm 30°**

Σετ 10 τεμαχίων



Κωδικός
VB-10 EVO

KDS**Ανταλλακτικές λεπίδες 18mm**

Σετ 10 τεμαχίων Πάχος: 0,5mm



Κωδικός
LB-10 EVO

KDS**Ανταλλακτικές λεπίδες 18mm μαύρες**

Σετ 10 τεμαχίων Πάχος: 0,6mm



Κωδικός
GB-10B EVO

KDS**Ανταλλακτικές λεπίδες ξύστρας 18mm μαύρες**

Χωρίς εγκοπές
Σετ 10 τεμαχίων



Κωδικός
LB-10BNL EVO

KDS**Ανταλλακτικές λεπίδες 25mm μαύρες**

Σετ 10 τεμαχίων



Κωδικός
HB-10B EVO

KDS**Ανταλλακτικές λάμμες παπαγαλάκια**

Σετ 5 τεμαχίων



Κωδικός
HK-5 EVO

KDS**Ανταλλακτικές λεπίδες για D-12**

10 τεμάχια

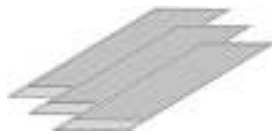

Κωδικός
DB-48

KDS**Ανταλλακτικές λεπίδες τραπεζοειδείς**

Κωδικός
195000

**Ανταλλακτικές λεπίδες τραπεζοειδείς μαύρες**

Σετ 5 τεμαχίων



Κωδικός
TB-5B

KDS

Λεπίδες σέγας σετ

HC12
HG13
HGS14
MG11
MG12



Κωδικός
ASSOR2000



Λεπίδες σέγας ξύλο-πλαστικό 75mm

5 τεμάχια
10 τρι



Κωδικός
HC12



Λεπίδες σέγας ξύλου ταχείας κοπής 50mm

5 τεμάχια
19 τρι



Κωδικός
HC12K



Λεπίδες σέγας ξύλο-πλαστικό 75mm

ανάποδα δόντια 5 τεμάχια
10 τρι



Κωδικός
HC12Rbi



Λεπίδες σέγας ξύλο-πλαστικό 75mm

5 τεμάχια
8,5 τρι



Κωδικός
HC13bi



Λεπίδες σέγας ξύλο-πλαστικό 75mm

5 τεμάχια
6,35



Κωδικός
HC14



Λεπίδες σέγας ξύλου 105mm

5 τεμάχια
10 τρι



Κωδικός
HC32



Λεπίδες σέγας ξύλο-πλαστικό 105mm

5 τεμάχια
6,35



Κωδικός
HC34



Λεπίδες σέγας ξύλο-πλαστικό 75mm

5 τεμάχια
8,5 τρι



Κωδικός
HG13



Λεπίδες σέγας ξύλο-πλαστικό 75mm

5 τεμάχια
8,5 τρι



Κωδικός
HG13G



Λεπίδες σέγας ξύλου ταχείας κοπής 75mm

5 τεμάχια
6,35



Κωδικός
HGS14



Λεπίδες σέγας ξύλου ταχείας κοπής 155mm

5 τεμάχια
6,35



Κωδικός
HGS54



Λεπίδες σέγας για laminate 60mm

ανάποδα δόντια 5 τεμάχια

13 τριΚωδικός
HC19Rbi

Λεπίδες σέγας για λάστιχο-πλαστικό 75mm

5 τεμάχια

Κωδικός
HWL100

Λεπίδες σέγας για λάστιχο-δέρμα-χαρτί 75mm

5 τεμάχια

Κωδικός
HWL54

Λεπίδες σέγας για μέταλλα 75mm

5 τεμάχια

8,5 τριΚωδικός
K14

Λεπίδες σέγας για μέταλλα 55mm

5 τεμάχια

21 τριΚωδικός
MG11

Λεπίδες σέγας για inox 55mm

5 τεμάχια

21 τριΚωδικός
MG11bi

Λεπίδες σέγας για inox 55mm

5 τεμάχια

13 τριΚωδικός
MG12

Λεπίδες σέγας για inox 105mm

5 τεμάχια

25 τριΚωδικός
MG31bi

Λεπίδες σέγας για panel 155mm

5 τεμάχια

25 τριΚωδικός
MG51bi

Λεπίδες σέγας πλαστικά-μέταλλα 75mm

5 τεμάχια

Κωδικός
ST006/bi

Λεπίδες σέγας για ξύλο-πλαστικό 91mm

PVC - Plexiglass - Πάγκους κουζίνας

5 τεμάχια

10 τριΚωδικός
HC123Star

Λεπίδες σέγας για ξύλο-πλαστικό 91mm

Για κούρμπες σε πάγκους κουζίνας

5 τεμάχια

10 τριΚωδικός
HC22DV

**Διαμαντολεπίδα σέγας για γυαλί-κεραμικά
100mm**

1 τεμάχιο

Κωδικός
DT1**Λεπίδες σέγας μέταλλα 75mm**

5 τεμάχια

21 τριΚωδικός
MMG1**Λεπίδες σέγας ξύλο-πλαστικό 75mm**

5 τεμάχια

10 τριΚωδικός
UHC12**Λεπίδες σέγας ξύλο-πλαστικό 105mm**

5 τεμάχια

6,35Κωδικός
UHC32**Λεπίδες σέγας ξύλο-πλαστικό 75mm**

5 τεμάχια

8,5 τριΚωδικός
UHG13**Λεπίδες σέγας για ξύλο 105mm**

5 τεμάχια

10 τριΚωδικός
UHGS34**Λεπίδες σέγας για μέταλλο 75mm**

5 τεμάχια

8,5 τριΚωδικός
UK14bi**Λεπίδες σέγας για μέταλλο 55mm**

5 τεμάχια

21 τριΚωδικός
UMG11**Λεπίδες σέγας για μέταλλο 55mm**

5 τεμάχια

21 τριΚωδικός
UMG11bi

Λεπίδες σπαθοσέγας ξύλο-μέταλλο

5 τεμάχια

10/14

Κωδικός Μήκος

1014C/150 130mm

1014C/225 205mm

1014C/280 260mm



Λεπίδες σπαθοσέγας ξύλο-μέταλλο

5 τεμάχια

10/14

Κωδικός Μήκος

1014CD/150 130mm

1014CD/225 205mm



Λεπίδες σπαθοσέγας για inox

5 τεμάχια

14 τρι

Κωδικός Μήκος

3013/250 250mm



Λεπίδες σπαθοσέγας για ξύλο-πλαστικό

5 τεμάχια

4 τρι

Κωδικός Μήκος

3019/150 130mm

3019/225 205mm



Λεπίδες σπαθοσέγας για ξύλο-πλαστικό

5 τεμάχια

6 τρι

Κωδικός Μήκος

3021/150 130mm

3021/225 205mm

3021/300 280mm



Λεπίδες σπαθοσέγας για ξύλο-πλαστικό

5 τεμάχια

6 τρι

Κωδικός Μήκος

3021/150bi 130mm

3021/225bi 205mm

3021/300bi 280mm



Λεπίδες σπαθοσέγας για ξύλο-πλαστικό

5 τεμάχια

6 τρι

Κωδικός Μήκος

3025/150 150mm

3025/300 300mm



Λεπίδες σπαθοσέγας για ξύλο-μέταλλο

3 τεμάχια

8,5 τρι

Κωδικός Μήκος

3028/230 195mm



Λεπίδες σπαθοσέγας για ξύλο

5 τεμάχια

4/5 τρι

Κωδικός Μήκος

3029/240 220mm



Λεπίδες σπαθοσέγας Hypercut

3 τεμάχια

10 τρι**Κωδικός Μήκος**

3050/150 130mm

3050/225 225mm

3050/300 280mm

**Λεπίδες σπαθοσέγας Hypercut**

3 τεμάχια

8/10**Κωδικός Μήκος**

3060/150 150mm

3060/225 225mm

3060/300 280mm

**Λεπίδες σπαθοσέγας για inox**

5 τεμάχια

14 τρι**Κωδικός Μήκος**

3014/150 150mm

3014/200 200mm

3014/280 280mm

**Λεπίδες σπαθοσέγας για inox**

5 τεμάχια

18 τρι**Κωδικός Μήκος**

3015/200 200mm

**Λεπίδες σπαθοσέγας για inox**

5 τεμάχια

10 τρι**Κωδικός Μήκος**

3018/150 150mm

3018/200 200mm

3018/280 280mm

**Λεπίδες σπαθοσέγας Dominator**

5 τεμάχια

10/14**Κωδικός Μήκος**

3056/225 225mm

3056/300 300mm

**Λεπίδες σπαθοσέγας για νωπά ξύλα**

5 τεμάχια

**Κωδικός Μήκος**

3039/300 300mm

**Διαμαντολεπίδα σπαθοσέγας για γυαλί - κεραμικά**

1 τεμάχιο

**Κωδικός Μήκος**

DT200 100mm

**Λεπίδες σπαθοσέγας για κατεψυγμένα κρέατα****INOX**

1 τεμάχιο

**Κωδικός Μήκος**

INOX 300 300mm

INOX 400 400mm

**Λεπίδα σπαθοσέγας για Y-tong και τούβλα**

1 τεμάχιο

Χάλυβας με επικάλυψη καρβιδίου βολφραμίου

Για σπαθοσέγες 1000W και άνω

**Κωδικός Μήκος**

3048/455HM 455mm



Ψαλίδια ραπτικής

D840



Κωδικός **Μήκος**
BCSCHPN150 150mm
BCSCHPN180 180mm



Ψαλίδια εργασίας

D860



Κωδικός **Μήκος**
BCSCN200 200mm
BCSCN225 225mm
BCSCN250 250mm



Ψαλίδι γενικής χρήσης

ERDI D53



Κωδικός **Μήκος**
BCSCN180 125mm



Ψαλίδι γενικής χρήσης



Κωδικός **Μήκος**
KSC-1 140mm



Ψαλίδι καλωδίων



Κωδικός **Μήκος**
9505155SB 155mm



Πολυχρηστικό ψαλίδι



Κωδικός **Μήκος**
9505190 190mm



Πολυχρηστικό ψαλίδι



Κωδικός **Μήκος**
D50 190mm



Κλαδευτήρι χυτό



Κωδικός **Τύπος**
8020-000 210mm



Κλαδευτήρι με μαλακές λαβές

■ *Made in Japan*



Κωδικός **Τύπος**
PSB-8G 210mm





Ψαλίδι πελεκάνος



Κωδικός Μήκος
SP 300mm



Ψαλίδι πελεκάνος



Κωδικός Μήκος
D22A 280mm



Ψαλίδι ίσιο



Κωδικός Μήκος
D16S 240mm



Ψαλίδι λαμαρίνας αριστερό



Κωδικός Μήκος
D16L 240mm



Ψαλίδι λαμαρίνας δεξί



Κωδικός Μήκος
D16R 240mm



Ψαλίδι nibbler



Κωδικός Μήκος
D24 265mm



Ψαλίδι ένωσης μπουριών



Κωδικός Μήκος
D36



Σιδηροπρίονο χειρός

Κωδικός Μήκος λάμας
240 300mm

**Σιδηροπρίονο μεγάλης αντοχής**

Αντιολισθητική λαβή
Γρήγορη αλλαγή λάμας



Κωδικός Τύπος
66301 300mm

**Σιδηροπρίονο**

90° - 45°
Λεπίδα από ατσάλι SK5



Κωδικός Τύπος
33548 300mm

**Σιδηροπρίονο μεταβλητού μήκους**

Κωδικός Τύπος
66303 135mm

**Σιδηροπρίονο ρυθμιζόμενου μήκους**

Σώμα χρωμίου - βαναδίου
Λεπίδα από ατσάλι



Κωδικός Τύπος
33549 150/230mm

**Σιδηροπρίονο χειρός μίνι**

Κωδικός Μήκος λάμας
242 150mm

**Σιδηροπρίονο μίνι**

Σώμα χρωμίου - βαναδίου
Λεπίδα από ατσάλι SK4



Κωδικός Τύπος
33550 150mm

**Σετ 2 λεπίδες για μίνι σιδηροπρίονα**

Κωδικός Τύπος
33570 150mm

**Λάμες σιδηροπρίονου**

12 τεμάχια (PUK)



Κωδικός Μήκος λάμας
238A 150mm



Πριόνι χειροτεχνίας



Κωδικός

530106-178030-0



Ανταλλακτικά πριονιού χειροτεχνίας Νο0

Δωδεκάδες



Κωδικός **Τύπος**

26-190000-0 Pinguin Gold

26-187500-0 Crafta

26-188003-0 Herkules



Πριόνι κλάδου



Κωδικός **Μήκος λάμας**

52431 245mm

52432 Ανταλλακτική λάμα



Πριόνι κλάδου



Κωδικός **Μήκος λάμας**

52433 275mm

52434 Ανταλλακτική λάμα



Πριόνι ξύλου γρήγορης κοπής



Κωδικός **Τύπος**

8007-265 265mm

8007-B26 Ανταλλακτική λεπίδα



Πριόνι PVC



Κωδικός **Τύπος**

8006-240 240mm

8006-B24 Ανταλλακτική λεπίδα



Πριόνι ξύλου - PVC ακριβείας



Κωδικός **Μήκος λάμας**

PW-235 235mm

PW-235 Ανταλλακτική λάμα



Σεγάτσα

Λεπίδα από ατσάλι SK5
Ενσωματωμένο χάρακα



Κωδικός **Τύπος**

33544 380mm



Δίσκοι κοπής ξύλου **NEO**

Τρύπα Ø22mm



Κωδικός **Τύπος**

419.90 Ø115mm

419.95 Ø230mm



Δίσκοι κοπής ξύλου με 14 δόντια

Αν πρόκειται να κόψετε μέταλλο,
θα πρέπει να χρησιμοποιήσετε
χαμηλές στροφές. Κόβει ακόμα
και τα σκληρότερα ξύλα,
"σάντουιτς" υλικών ακόμα
και αν περιέχουν και μέταλλο.



Κωδικός **Διάμετρος**

10.8050230 230mm



Πριόνι τύπου Ιαπωνίας

Shogun Ryoba



Κωδικός	Τύπος
410	240mm
411	Ανταλλακτική λεπίδα

**Πριόνι handy****HANDY UTILITY H-200**

Ιδανικό για εργασίες σε περιορισμένους χώρους

- Made in Japan



Κωδικός	Τύπος
15086	200mm 15τπi Ø0,5mm Kerf:0,70mm
15087	Ανταλλακτική λεπίδα

**Πριόνι universal****UNIVERSAL H-300**

Κατάλληλο για όλους τους τύπους κοψίματος

- Made in Japan



Κωδικός	Τύπος
15011	300mm 12τπi Ø0,7mm Kerf:1,07mm
15012	Ανταλλακτική λεπίδα

**Πριόνι αναδιπλούμενο****V HANDY 200 CARPENTRY**

Για γενική ξυλεια, πολυστρωματική, κόντρα πλακέ

- Made in Japan



Κωδικός	Τύπος
18411	200mm 15τπi Ø0,5mm Kerf:0,70mm
15087	Ανταλλακτική λεπίδα

**Πριόνι αναδιπλούμενο****VIII 265**

Επαγγελματικό πριόνι ξυλουργικής για κοπή σανίδων & ξύλων

- Made in Japan



Κωδικός	Τύπος
18401	265mm 15τπi Ø0,6mm Kerf:0,92mm
18402	Ανταλλακτική λεπίδα

**Πριόνι ακριβείας Dozuki****HANDY 150 FINE CRAFT**

Κόβει μαλακά μέταλλα & ξύλο

- Made in Japan



Κωδικός	Τύπος
07041	157mm 28τπi Ø0,3mm Kerf:0,36mm
07042	Ανταλλακτική λεπίδα

**Πριόνι Dozuki****DOZUKI PIERCING 150**

Για αποκατάσταση επίπλων, ακριβών έργων, παραγωγή μουσικών οργάνων

- Made in Japan



Κωδικός	Τύπος
07101	150mm 18τπi Ø0,3mm Kerf:0,49mm
07102	Ανταλλακτική λεπίδα

**Πριόνι Dozuki****DOZUKI HARDWOOD 150**

Για επαγγελματίες κατασκευαστές επίπλων και αναστηλωτές

Εξαιρετικά λεπτή λεπίδα

- Made in Japan



Κωδικός	Τύπος
07105	150mm 21τπi Ø0,3mm Kerf:0,43mm
07106	Ανταλλακτική λεπίδα

**Πριόνι Dozuki****DOZUKI HARDWOOD 240**

Για επαγγελματίες κατασκευαστές επίπλων και αναστηλωτές

Εξαιρετικά λεπτή λεπίδα

- Made in Japan



Κωδικός	Τύπος
07123	240mm 21τπi Ø0,3mm Kerf:0,43mm
07124	Ανταλλακτική λεπίδα





Πρινοκορδέλες M42

**M42**

Κωδικός	Πλάτος	Πάχος	Δόντια	Κωδικός	Πλάτος	Πάχος	Δόντια
50MAT13646	12,7mm	0,64mm	6/10	50M421990812	19mm	0,90mm	8/12
50M421364812	12,7mm	0,64mm	8/12	50M42279010?	27mm	0,90mm	10/14
50M421390101	12,7mm	0,90mm	10/14	50M42279046	27mm	0,90mm	4/6
50MAT1364121	12,7mm	0,64mm	12/16	50M42279058	27mm	0,90mm	5/8
50MAT1364141	12,7mm	0,64mm	14/18	50M422790610	27mm	0,90mm	6/10
50M42199010?	19mm	0,90mm	10/14	50M422790812	27mm	0,90mm	8/12
50M422790580	19mm	0,90mm	5/8	50M42341146	34mm	1,10mm	4/6
50M42199061?	19mm	0,90mm	6/10	50M42341158	34mm	1,10mm	5/8

Δίσκοι σμυριδόπανου 115mm

Τρύπα: 22mm

Κωδικός	Grit
115ZK40	40
115ZK60	60
115ZK80	80
115ZK120	120



Δίσκοι σμυριδόπανου 125mm

Τρύπα: 22mm

Κωδικός	Grit
125ZK40	40
125ZK60	60
125ZK80	80
125ZK120	120



Δίσκοι λείανσης

Τρύπα: 22mm



Κωδικός	Τύπος
80271156M	115X6mm
80271256M	125X6mm
80271806M	180X6mm
80272306M	230X6mm

Δίσκοι λείανσης inox

PREMIUMFLEX A24/30S-BF INOX T27



Κωδικός	Διάμετρος	Πάχος
GI1156022	115mm	6mm
GI1256422	125mm	6,4mm

Δίσκοι λείανσης μετάλλων

PREMIUMFLEX A24/30S-BF T27



Κωδικός	Διάμετρος	Πάχος
GM1156022	115mm	6mm
GM1256022	125mm	6mm
GM1806522	180mm	6,5mm
GM2306522	230mm	6,5mm

Δίσκοι λείανσης μετάλλου

A24/30S-BF T27



Κωδικός	Τύπος
AS000667V980	115X6,0X22mm
AS000692V980	125X6,0X22mm
AS000762V980	230X6,0X22mm

Δίσκοι λείανσης inox

A24X-BF INOX T27



Κωδικός	Τύπος
CPAS003100	115X6X22mm
CPAS003101	125X6X22mm
GI1806822	180X6,4X22mm
AS003104V9802	230X6X22mm

Δίσκοι με καρβίδια με 90 δόντια



Κωδικός	Διάμετρος
10.7100355030	355x2,4x25,4mm



Δίσκοι κοπής μετάλλου

Τρύπα: 22mm

Κωδικός	Τύπος
80411151	115X1mm
804111525M	115X2,5mm
80411251	125X1mm
804112525M	125X2,5mm
804118025M	180X2,5mm
804123019	230X1,9mm
804123025M	230X2,5mm

**Δίσκοι κοπής inox special**

Τρύπα: 22mm

Κωδικός	Τύπος
P804111519S	115X1mm
P804112519S	125X1mm
P804123019S	230X1,9mm

**Δίσκοι κοπής all in one**

Κατάλληλοι για ασφάλι, ανοξείδωτα, PVC, αλουμίνιο, μπετόν

Τρύπα: 22mm

Κωδικός	Τύπος
SPC80411151	115X1mm
SPC80411251	125X1mm

**Δίσκοι κοπής μετάλλων ίσιοι για inox**

PROMAX A60X-BF INOX T41

Πάχος 1mm

Κωδικός	Διάμετρος
CM1151022	115mm
CM1251022	125mm

**Δίσκοι κοπής inox**

A60T-BF INOX T41

Κωδικός	Τύπος
AT001655V980	115X1,0X22mm
AT001685V980	125X1,0X22mm
AT001782V9802	230X2,0X22mm

**Δίσκοι κοπής μετάλλου**

A26U-BF T41

Κωδικός	Τύπος
AT001656V980	115X2,0X22mm
CPM1252022	125X2,0X22mm
AT001742V9802	180X2,0X22mm
AT001781V9802	230X2,0X22mm

**Δίσκοι κοπής μετάλλου**

A30T-BF T41

Κωδικός	Τύπος
AT010022	300X3,5X32mm
AT010022	350X3,5X25,4mm



Δίσκοι κοπής πέτρας

Τρύπα: 22mm



Κωδικός	Τύπος
804111516S	115X1,6mm
804112516S	125X1,6mm
80412303S	230X3,0mm

**Δίσκοι κοπής πέτρας**

C24S-BF T41



Κωδικός	Τύπος
AT115025V980	115X2,5X22mm
CS1251622	125X1,6X22mm
AT125025V980	125X2,5X22mm
AT230030V980	230X3,0X22mm

**Δίσκοι κοπής μαρμάρου πάχους 1,6mm**PREMIUMFLEX C46R-BF
BEST LIFE

Κωδικός	Τύπος
CS1151622	115X1,6mm
CS1251622	125X1,6mm

**Σμυριδοτροχοί γενικής χρήσης**

ALU-OXIDE CERAMIC WHEEL

Για μέταλλα

Τρύπα: 32mm

Κωδικός	Τύπος	Grit
A1252032A36	125X20mm	A36
A1252032A46	125X20mm	A46
A1502032A36	150X20mm	A36
A1502032A46	150X20mm	A46
A2002032A36	200X20mm	A36
A2002032A46	200X20mm	A46
A2002532A36	200X25mm	A36
A2002532A46	200X25mm	A46

**Σμυριδοτροχοί για βίντια**

GREEN SIC CERAMIC WHEEL

Τρύπα: 32mm

Κωδικός	Τύπος	Grit
CAR1252032	125X20mm	80
CAR1502032	150X20mm	80
CAR2002032	200X20mm	80
CAR2002532	200X25mm	80



Διαμαντόδισκος

Κόβει: μπετόν



Κωδικός	Διάμετρος	Πάχος
54318	115mm	
54317	125mm	
54319	230mm	

Kapriol**Διαμαντόδισκοι NEO**

JC 190 Klinker
Κόβει: Κεραμικά, κλίνκερ,
πορσελάνη Gres, μάρμαρο.

Υγρής & ξηράς κοπής



Κωδικός	Διάμετρος	Πάχος
54360	115mm	1,6mm
54361	230mm	2,0mm

Kapriol**Διαμαντόδισκος**

Κόβει: μπετόν, τούβλο, πέτρα



Κωδικός	Διάμετρος	Πάχος
54115	115mm	
54107	125mm	
54116	230mm	

Kapriol**Διαμαντόδισκος**

Κόβει: μπετόν, τούβλο, πέτρα



Κωδικός	Διάμετρος	Πάχος
54108	115mm	
54104	125mm	
54109	230mm	

Kapriol**Διαμαντόδισκοι γενικής χρήσης NEO**

DS 145 T
Κόβει: τούβλο, σκυρόδεμα,
οπλισμένο σκυρόδεμα,
γρανίτη, πέτρα.

Υγρής & ξηράς κοπής

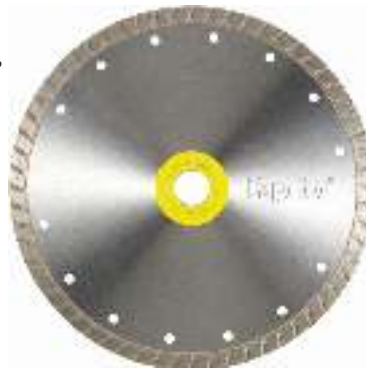

Κωδικός	Διάμετρος	Πάχος
54020	115mm	2,4mm
54021	230mm	2,8mm

Kapriol**Διαμαντόδισκος κοπής πλακιδίων**

DS 100 T
Υγρής & ξηράς κοπής.



Κωδικός	Διάμετρος	Πάχος
54001	230mm	3mm

Kapriol**Δίσκος κοπής για ξύλο - γυψοσανίδες - PVC**

Expert
Ξηράς κοπής



Κωδικός	Διάμετρος	Πάχος
54835	115mm	
54837	230mm	

Kapriol**Διαμαντόδισκος κοπής δομικών υλικών**

JC 190
Υγρής & ξηράς κοπής



Κωδικός	Διάμετρος	Πάχος
54366	230mm	1,6mm

Kapriol



Δίσκοι κοπής HSS

Κωδικός	Τύπος	Δόντια
D2001832200	200X1,80X32	200
D2251932180	225X1,80X32	180
D2251932220	225X1,90X32	220
D2252032180	225X2,00X32	180
D2252032220	225X2,00X32	220
D2502032160	250X2,00X32	160
D2502032200	250X2,00X32	200
D2752532220	275X2,500X32	220
D3002532220	300X2,500X32	220
D3152532220	315X2,500X32	220



Δίσκοι κοπής HSS κοβαλτίου

Κωδικός	Τύπος	Δόντια
DC2250232180	225X2,00X32	180
DC2250232220	225X2,00X32	220
DC2502032200	250X2,00X32	200
DC2502032160	250X2,00X32	160
DC2752532220	275X2,500X32	220
DC3002532220	300X2,500X32	220
DC3152532220	315X2,500X32	220



Κοπτικά τρύπας μετάλλων ET

ART.20.1020

Κωδικός	Τύπος	Κωδικός	Τύπος	Κωδικός	Τύπος	Κωδικός	Τύπος
20.1020.014	Ø14	20.1020.028	Ø28	20.1020.042	Ø42	20.1020.060	Ø60
20.1020.016	Ø16	20.1020.030	Ø30	20.1020.045	Ø45	20.1020.063	Ø63
20.1020.018	Ø18	20.1020.032	Ø32	20.1020.048	Ø48	20.1020.065	Ø65
20.1020.020	Ø20	20.1020.034	Ø34	20.1020.050	Ø50	20.1020.068	Ø68
20.1020.022	Ø22	20.1020.035	Ø35	20.1020.052	Ø52		
20.1020.024	Ø24	20.1020.038	Ø38	20.1020.054	Ø54		
20.1020.025	Ø25	20.1020.040	Ø40	20.1020.058	Ø58		



Ποτηροκορώνες με βίντια

ART.20.1315 για μαγνητικά δράπανα

Κωδικός	Τύπος	Κωδικός	Τύπος	Κωδικός	Τύπος
20.1315.014	Ø14	20.1315.024	Ø24	20.1315.038	Ø38
20.1315.015	Ø15	20.1315.025	Ø25	20.1315.040	Ø40
20.1315.016	Ø16	20.1315.028	Ø28	20.1315.042	Ø42
20.1315.017	Ø17	20.1315.030	Ø30	20.1315.045	Ø45
20.1315.018	Ø18	20.1315.032	Ø32	20.1315.048	Ø48
20.1315.020	Ø20	20.1315.034	Ø34	20.1315.050	Ø50
20.1315.022	Ø22	20.1315.035	Ø35		





Κοπτικά τρύπας μετάλλων με βίντια

Κωδικός	Τύπος	Κωδικός	Τύπος	Κωδικός	Τύπος
20.1130.014	Ø14	20.1130.030	Ø30	20.1130.063	Ø63
20.1130.015	Ø15	20.1130.032	Ø32	20.1130.065	Ø65
20.1130.016	Ø16	20.1130.034	Ø34	20.1130.068	Ø68
20.1130.017	Ø17	20.1130.036	Ø36	20.1130.070	Ø70
20.1130.018	Ø18	20.1130.038	Ø38	20.1130.073	Ø73
20.1130.019	Ø19	20.1130.040	Ø40	20.1130.075	Ø75
20.1130.020	Ø20	20.1130.042	Ø42	20.1130.080	Ø80
20.1130.021	Ø21	20.1130.045	Ø45	20.1130.085	Ø85
20.1130.022	Ø22	20.1130.046	Ø46	20.1130.090	Ø90
20.1130.023	Ø23	20.1130.048	Ø48	20.1130.095	Ø95
20.1130.024	Ø24	20.1130.050	Ø50	20.1130.100	Ø100
20.1130.025	Ø25	20.1130.052	Ø52	20.1130.110	Ø110
20.1130.026	Ø26	20.1130.055	Ø55	20.1130.120	Ø120
20.1130.027	Ø27	20.1130.058	Ø58		
20.1130.028	Ø28	20.1130.060	Ø60		



Karnasch
UNIVERSAL TOOLS

Ποτηροτρύπανα μετάλλου

Κωδικός	Τύπος	Κωδικός	Τύπος	Κωδικός	Τύπος
20.1500.014	Ø14	20.1500.041	Ø41	20.1500.073	Ø73
20.1500.016	Ø16	20.1500.043	Ø43	20.1500.076	Ø76
20.1500.017	Ø17	20.1500.044	Ø44	20.1500.079	Ø79
20.1500.019	Ø19	20.1500.045	Ø45	20.1500.083	Ø83
20.1500.020	Ø20	20.1500.046	Ø46	20.1500.089	Ø89
20.1500.021	Ø21	20.1500.048	Ø48	20.1500.092	Ø92
20.1500.022	Ø22	20.1500.050	Ø50	20.1500.095	Ø95
20.1500.024	Ø24	20.1500.051	Ø51	20.1500.098	Ø98
20.1500.025	Ø25	20.1500.052	Ø52	20.1500.102	Ø102
20.1500.027	Ø27	20.1500.054	Ø54	20.1500.105	Ø105
20.1500.028	Ø28	20.1500.057	Ø57	20.1500.108	Ø108
20.1500.029	Ø29	20.1500.059	Ø59	20.1500.114	Ø114
20.1500.030	Ø30	20.1500.060	Ø60	20.1500.121	Ø121
20.1500.032	Ø32	20.1500.064	Ø64	20.1500.127	Ø127
20.1500.033	Ø33	20.1500.065	Ø65	20.1500.140	Ø140
20.1500.035	Ø35	20.1500.067	Ø67	20.1500.152	Ø152
20.1500.038	Ø38	20.1500.068	Ø68	20.1500.160	Ø160
20.1500.040	Ø40	20.1500.070	Ø70		



Karnasch
UNIVERSAL TOOLS



Σετ ποτηροτρύπανα ξύλου

Νέου τύπου με 6 λεπίδες
32/38/45/51/57/63mm



Κωδικός Τύπος Βάθος
2073-006 32-63mm 50mm

TopMan

Σετ ποτηροτρύπανα ξύλου

Με 7 λεπίδες
25/32/38/45/51/57/63mm



Κωδικός Τύπος Βάθος
2072-020 25-63mm 20mm
2072-045 25-63mm 45mm

TopMan

Σετ ποτηροτρύπανα ξύλου B/T

Βάθος κοπής: 40mm



Κωδικός Τύπος
2077-040 46-53-59-66-73-82-94mm
2077-121 68-74-83-92-102-114-121mm

TopMan

Κώνικες φρέζες κοβαλτίου



Κωδικός Τύπος
20.1447 Ø4-12
20.1448 Ø4-20
20.1449 Ø6-32
20.1450 Ø6-36
20.1470U Ø6-38

Karnasch

Κεντραδόροι ποτηροτρύπανου

μαγνητικών δρασάνων



Κωδικός Τύπος
20.1249 Ø6,34X90
20.1273 Ø7,98X105
20.1403 Ø7,98X145
20.1151 Ø7,98X157

Karnasch

Αντάπτορας ποτηροτρύπανων

N2 3/8"



Κωδικός Τύπος
20.1503 32-152

Karnasch

Αντάπτορας ποτηροτρύπανων

SDS plus



Κωδικός Τύπος
20.1511 32-152

Karnasch

Αντάπτορας ποτηροτρύπανων

N1



Κωδικός Τύπος
20.1507 14-30

Karnasch

Κεντραδόρος κοπτικών



Κωδικός Τύπος
20.1133 8X80mm

Karnasch

Κεντραδόρος κοπτικών

Βαρέως τύπου



Κωδικός Τύπος
20.1445 6X80mm

Karnasch

Κεντραδόρος κοπτικών



Κωδικός Τύπος
20.1505 6X80

Karnasch

Κεντραδόρος κοπτικών

Για το 20.1020



Κωδικός Τύπος
20.1114 6X47

Karnasch

Βελόνι SDS plus



Κωδικός Μήκος
50200250 250mm



Κοπίδι SDS plus



Κωδικός Τύπος
50220250 20X250mm



Κοπίδι φαρδύ SDS plus



Κωδικός Μήκος
50240250 40X250mm



Καλέμι λούκι SDS plus



Κωδικός Μήκος
276P250/22 22X250mm



Καλέμι πεταλούδα SDS plus



Κωδικός Μήκος
277P250/22 22X250mm



Κοπίδι κυρτό SDS plus



Κωδικός Τύπος
279P200/40 40X200mm



Βελόνι SDS plus



Κωδικός Μήκος
21225001 250mm



Κοπίδι SDS plus



Κωδικός Μήκος
21225000 250mm



Κοπίδι φαρδύ SDS top



Κωδικός Μήκος
275240250 250mm



Κοπίδι κυρτό SDS MAX



Κωδικός Μήκος
279M300/50 50X300mm



Καλέμι λούκι SDS MAX



Κωδικός Μήκος
276M300/26 26X300mm



Καλέμι πεταλούδα SDS MAX



Κωδικός Μήκος
277M380/35 35X380mm



Βελόνια SDS MAX



Κωδικός Μήκος
503000280 280mm
503000400 400mm
503000600 600mm



Κοπίδια SDS MAX



Κωδικός Μήκος
273M280/25 280mm
273M400/25 400mm
273M600/25 600mm



Κοπίδια φαρδιά SDS MAX



Κωδικός Τύπος
275M300/80 80X300mm
275M400/50 50X400mm



**Μαχαίρια προσώπου K/10, P30, R, L**

DIN 4980 ISO 6

Τετράγωνα**Τύπος**

10X10X90
12X12X100
16X16X110
20X20X125
25X25X140
32X32X170

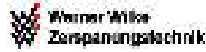
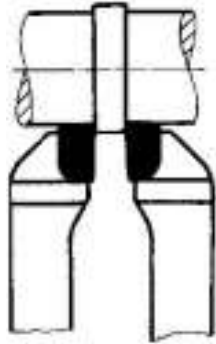
**Τρύπας ξεχονδρίσματος R3 P30 K/10**

DIN 4974 ISO 9

Τύπος

8X8X125
10X10X150
12X12X180
16X16X210
20X20X250
25X25X300

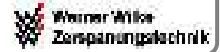
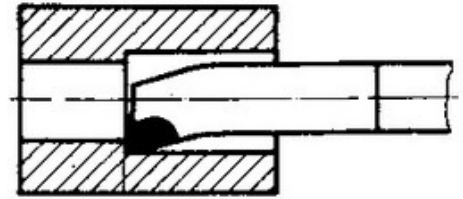
**Σχισίματος R, L, K/10, P30**

DIN 4981 ISO 7

Τύπος

12X8X10X3
16X10X110X4
20X12X125X5
25X16X140X6
32X20X170X8

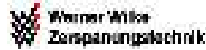
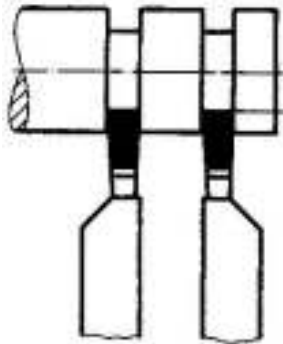
**Εσωτερικού σπειρώματος R, R30**

WN 283 ISO 13

Τύπος

10X10
12X12
16X16
20X20
25X25

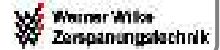
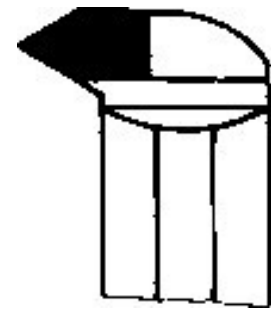
**Εσωτερικού σχισίματος R, P30**

WN 263 ISO 11

Τύπος

10X10
12X12
16X16
20X20
25X25

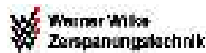
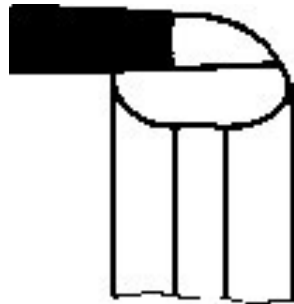
**Εξωτερικού σπειρώματος R, R30**

WN 282 ISO 12

Τύπος

12X8
16X10
20X12
25X16
32X20

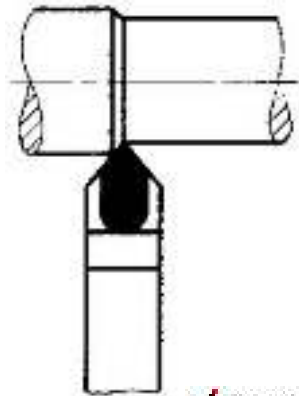
**Σχισίματος 12,5% Κοβάλτιο****Τύπος**

3/4"X3X150
3/4"X4X150
1"X4X150
7/8"X3X150
7/8"X4X150
1"X5X150
5/8"X3X150
1/2"X3X150

**Τετράγωνα 12,5% Κοβάλτιο****Τύπος**

6X6X100
8X8X100
10X10X100
12X12X100



**Κονδύλια κοβαλτίου δίπτερα**

Art.4420

Κωδικός	Τύπος
44255	3mm
44261	4mm
44267	5mm
44273	6mm
44279	7mm
44285	8mm
44297	10mm
44306	12mm
44312	14mm
44318	16mm
44324	18mm
44330	20mm

**Κονδύλια κοβαλτίου δίπτερα μακριά**

Art.4426

Κωδικός	Τύπος
44366	4mm
44369	5mm
44372	6mm
44378	8mm
44384	10mm
44390	12mm

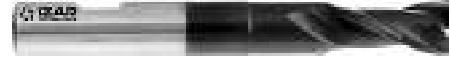
**Κονδύλια κοβαλτίου τετράπτερα κοντά**

Art.4400

Κωδικός	Τύπος
43784	3mm
43790	4mm
43796	5mm
43802	6mm
43808	7mm
43814	8mm
43826	10mm
43832	12mm
43838	14mm
43844	16mm
43850	18mm
43856	20mm
43859	22mm
43862	24mm
43865	25mm

**Κονδύλια κοβαλτίου πολύπτερα μακριά**

Art.4606

Κωδικός	Τύπος
46391	4mm
46394	5mm
46397	6mm
46403	8mm
46409	10mm
46415	12mm
46418	14mm
46421	16mm
46424	18mm
46427	20mm

**Κονδύλι μονόπτερο αλουμινίου**

ART.4414

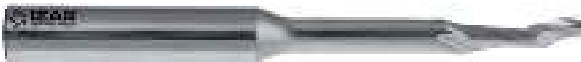

Κωδικός	Τύπος
44129	8mm



Τηλεσκοπικός καθρέπτης



Κωδικός Μήκος
6061



Τηλεσκοπικός καθρέπτης με μαγνήτη



Κωδικός Μήκος
617 ≤630mm



Εύκαμπτη αρπάγη

για συλλογή αντικειμένων από δύσκολα σημεία

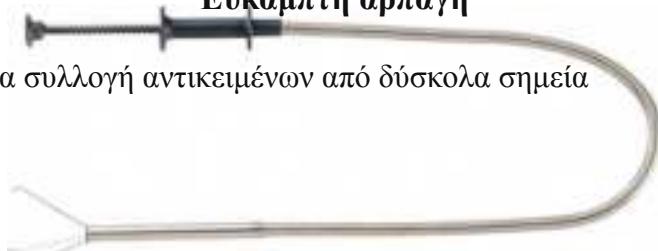

Κωδικός Μήκος
88901 560mm



Τηλεσκοπικός μαγνήτης



Κωδικός Τύπος
88902 1,6kg



Εύκαμπτο σπирάλ με μαγνήτη

για συλλογή αντικειμένων ≤1,6kg από δύσκολα σημεία



Κωδικός Μήκος
61701 440mm



Εύκαμπτο σπирάλ με μαγνήτη

για συλλογή αντικειμένων ≤0,7kg από δύσκολα σημεία



Κωδικός Μήκος
61702 510mm



Σετ εργαλείων επιθεώρησης



Κωδικός
617A



Μαγνητιστής - απομαγνητιστής



Κωδικός
88601



Τηλεσκοπικός μαγνήτης με καθρέπτη

Εύκαμπτος φωτιζόμενος



Κωδικός Μήκος
617L 530mm



Θερμόμετρο υπερέθρων



Κωδικός Τύπος
9U0401 -20°C - +500°C





Αλοιφές κοπτικών



Κωδικός Συσκευασία
 60.1159 125gr
 60.1157 750gr



Λιπαντικό κερι κοπτικών



Κωδικός Συσκευασία
 60.1200 350ml



Σπρέι υγρό κοπής

OLIO TAGLIO



Κωδικός
 83010/04
Συσκευασία
 400ml



Σπρέι τσιμπιδας

ANTIADDESIVO
 SALDATURA



Κωδικός
 80610/04
Συσκευασία
 400ml



Σπρέι καλουπιών σιλικονούχο

DISTACCANTE



Κωδικός
 83610/04
Συσκευασία
 400ml



Σπρέι μάντων

ANTISLITTANTE
 CINGHIE



Κωδικός
 83110/04
Συσκευασία
 400ml



Σαπουνέλαιο



Κωδικός
 83050/05
Συσκευασία
 5l



Σαπουνέλαιο λευκό



Κωδικός
 84450/05
Συσκευασία
 5l





Σπρέι υπεσυντηρητής 8 λειτουργιών

W8



Κωδικός	Συσκευασία
81710/02W8	200 ml
81710/04W8D	400 ml
81710/04W8DJ	400 ml Smart



Σπρέι αντισκωριακό

SUPER SBLOCCANTE



Κωδικός
81710/04
Συσκευασία
400ml



Σπρέι κατά του σκουριάματος

ANTIOSSIDANTE



Κωδικός
85110/04
Συσκευασία
400ml



Σπρέι σιλκόνης

SILICONE SPRAY



Κωδικός
80410/04
Συσκευασία
400ml



Σπρέι λιπαντικό ξηρό τεφλόν

LUBRIFICANTE
SECCO



Κωδικός
85210/04
Συσκευασία
400ml



Σπρέι βαζελίνης

OLIO VASELINA



Κωδικός
81910/04
Συσκευασία
400ml



Σπρέι ελέγχου διαρροής αερίου

RICERCA GAS



Κωδικός
81110/04
Συσκευασία
400ml



Σπρέι ελέγχου διαρροής αερίων

GAS CONTROL



Κωδικός Συσκευασία
405000EX 400 ml



Σπρέι γράσο γενικής χρήσης

GRASSO MILLEUSI

**Κωδικός**

83810/04

Συσκευασία

400ml

**Σπρέι γράσο θαλάσσης**

GRASSO NAUTICA

**Κωδικός**

83910/04

Συσκευασία

400ml

**Σπρέι γράσο καδένας**

GRASSO CATENE

**Κωδικός**

84010/04

Συσκευασία

400ml

**Σπρέι γράσο υψηλής θερμοκρασίας 700°C**

GRASSO 700°C

**Κωδικός**

84110/04

Συσκευασία

400ml

**Σπρέι γράσο υψηλής θερμοκρασίας 1000°C**

GRASSO 1000°C

**Κωδικός**

85410/04

Συσκευασία

400ml

**Γράσο γενικής χρήσης**

GRASSO MILLEUSI

**Κωδικός** **Συσκευασία**

83830/125

125 ml

83830/50

500 ml

83830/01

900 γρ

83830/45

4,6 κιλά

**Γράσο βαζελίνης**

GRASSO VASELINA

**Κωδικός** **Συσκευασία**

81930/125

125 ml

**Γράσο θαλάσσης**

GRASSO NAUTICA

**Κωδικός** **Συσκευασία**

83930/125

125 ml

83930/50

500 ml

83930/01

900 γρ

**Γράσο υψηλής θερμοκρασίας**

GRASSO ALTE TEMPERATURE

**Κωδικός** **Συσκευασία**

84130/125

125 ml

84130/01

900 γρ

**Γράσο σιλικόνης**

GRASSO SILICONICO

**Κωδικός** **Συσκευασία**

84230/125

125 ml

**Σταντ με σωληνάρια γράσσου**

125ml 125ml 125ml

**Κωδικός** **Συσκευασία**

85030/MIX1

30 τεμ.

**Γράσο σε φισίγγιο****Κωδικός** **Τύπος**

12511

400gr



**Βενζινόκολλα**

Κωδικός Συσκευασία
BALLY CTU 50ml

Σπρέι κόλλα

COLA SPRAY



Κωδικός Συσκευασία
81410/04 400ml

**Ασφαλιστικά μπουλονιών 50ml**

FRENAFILETTI



Κωδικός Τύπος
67201/50 F1222
67202/50 F1243
67203/50 F1270

**Υγρό τεφλόν 50ml**

PTFE LIQUIDO



Κωδικός Τύπος
67204/50 572

**Ατσαλόστοκος**

EPOXY STICK



Κωδικός Συσκευασία
69010/57 57gr

**Ράβδοι σιλικόνης διαφανείς**

Ø11,5mm μήκος 30cm

Ιξώδες: 8500 ±1000CPS @180°C

Σημείο πήξης: 84°C ±3°C

Χρόνος τήξης: 15-20 sec

Open time: 30-40 sec

Θερμοκρασία εφαρμογής:
150-180°CΕξαιρετική
αντίσταση στο νερό

Κωδικός Τύπος
Κιβώτιο 10 κιλών
Κιλό (35 τεμάχια)

**Κόλλα γενικής χρήσης**

VINYLPROF



Κωδικός Συσκευασία
69850/75 500gr





Καθαριστικά χεριών

STAR



Κωδικός Συσκευασία
60010/01 1 λίτρο
60010/04 4 λίτρα



Καθαριστικό χεριών με αντλία

PLUS



Κωδικός Συσκευασία
60110/05 5 λίτρα



Καθαριστικό για ανοξείδωτα

PULINOX



Κωδικός Συσκευασία
62510/75 750 ml



Καθαριστικό υγρό

για σκουριά,
κονιάματα, άλατα
PULIMETAL



Κωδικός Συσκευασία
61710/750 750ml



Σπρέν αέρας

ARIA SPRAY



Κωδικός Συσκευασία
89110/04 400ml



**Σπρέι καθαρισμού
κλιματιστικών αυτοκινήτου**

ECO CLIMAT



Κωδικός
84710/04
Συσκευασία
400ml



Σπρέι λίπανσης επαφών

PROTETTIVO CONTATTI



Κωδικός Συσκευασία
83710/02 200 ml



Σπρέι καθαρισμού επαφών

PULITORE CONTATTI



Κωδικός Συσκευασία
85710/02 200 ml



Αποφρακτικό υγρό

SGORG LIQUIDO



Κωδικός Συσκευασία
61850/01 1l





Αλοιφή γυαλίσματος

SHINE



Κωδικός Συσκευασία
29-10000-0 75 ml



Αλοιφή γυαλίσματος για μέταλλα

METAL POLISH



Κωδικός Συσκευασία
29-10100-0 75 ml



Αλοιφή γυαλίσματος για inox

STAINLESS STEEL



Κωδικός Συσκευασία
29-103000-0 75 ml



Αλοιφή γυαλίσματος marine

MARINE SHINE



Κωδικός Συσκευασία
01-001190 75 ml
29-106200-0



Διαλυτικό νίτρου

DILUENTE



Κωδικός Συσκευασία
60750/01 11



Χρώμα ψυχρού γαλβανίσματος 1 κιλό



Κωδικός	Χρώμα
81350/75C	Ασημί
81350/75 (SCURO)	Μολυβί





Ακρυλικά σπρέι 400ml

Κωδικός	Χρώμα	Κωδικός	Χρώμα
90010/001P	RAL9005 Μαύρο	90010/010P	RAL1021 Κίτρινο
90010/072P	RAL9005 Μαύρο σατινέ	90010/028P	RAL1015 Μπεζ
90010/030P	RAL9005 Μαύρο ματ	90010/015P	RAL6002 Πράσινο
90010/002P	RAL9010 Λευκό	90010/022P	RAL6029 Μέντα
90010/031P	RAL9010 Λευκό ματ	90010/	RAL6005 Κυπαρισί
90010/002P	RAL3000 Κόκκινο	90010/020P	RAL2004 Πορτοκαλί
90010/004P	RAL3001 Κόκκινο	90010/025P	RAL5003 Μπλε σκούρο
90010/013P	RAL3003 Κόκκινο	90010/	RAL5012 Μπλε ανοικτό
90010/027P	RAL3020 Κόκκινο	90010/024P	RAL5015 Ουρανό
90010/016P	RAL8017 Καφέ	90010/007P	RAL5017 Μπλε
90010/006P	RAL8016 Καφέ	90010/051P	RAL4006 Μωβ
90010/021P	RAL8011 Καφέ	90010/029P	RAL9006 Αλουμίνιο
90010/057P	RAL8003 Καφέ	90010/	RAL7001 Γκρι
90010/011P	RAL1007 Ώχρα	90010/	RAL7031 Γκρι - μπλε
90010/044P	RAL1023 Κίτρινο	90010/	RAL7016 Ανθρακί



Σπρέι φωσφοριζέ 400ml

FLUORESCENTE



Κωδικός	Χρώμα
70110/101	Κίτρινο
70110/103	Κόκκινο



Σπρέι μεταλλικό 400ml

EFFECT



Κωδικός	Χρώμα
90310/302P	Χρυσό
90310/304P	Χαλκός
90710/706P	Νίκελ καθρέπτης
90710/705P	Χρυσό καθρέπτης



Σπρέι υψηλής θερμοκρασίας

400ml

ALTE
TEMPERATURE



Κωδικός	Χρώμα
90510/502P	Μαύρο γαλιστερό
90510/501P	Μαύρο ματ
90510/504P	Αλουμίνιο
90510/503P	Λευκό ματ
90510/506P	Κόκκινο



Σπρέι σμάλτο 400ml

SPECIAL
BIANCO
ELETTRODOMESTICI



Κωδικός	Χρώμα
90610/603P	Λευκό



Σπρέι βαφής για ζάντες 400ml

SPECIAL
ALLUMINIO
RUOTE



Κωδικός	Χρώμα
90610/607P	Αλουμίνιο



**Σπρέι γαλβανίσματος 400ml**

ZINCO CHIARO



Κωδικός	Χρώμα
81310/04	Γκρι λαμπερό

**Σπρέι inox 400ml**

ACCIAIO INOX



Κωδικός	Χρώμα
81810/04	

**Σπρέι βερνίκι διαφανές 400ml**

SPECIAL TRASPARENTE



Κωδικός	Χρώμα
90610/601P	Γυαλιστερό
90610/605P	Ματ
90410/04	Πλαστικοποίησης

**Σπρέι αντισκωριακό αστάρι 400ml**SPECIAL
FONDO ANTIRUGGINE
GRIGIA

Κωδικός	Χρώμα
90610/604P	Γκρι

**Σπρέι λαστιγόπισσα 500ml**

CATRAMIX



Κωδικός
86810/05

**Σπρέι καθαριστικό κινητήρα
400ml**

LAVAMOTORI



Κωδικός
82110/04

**Σπρέι διαλύτης πάγου 400ml**

DEGHIACCIANTE



Κωδικός
85010/04

**Σπρέι καθαρισμού φρένων 500ml**

PULITORE FRENI



Κωδικός
82210/04

**Σπρέι γράσο κατάλληλο για τρόφιμα 400ml** **NEO**

LG1



Κωδικός
86710/04



Μετροταινία 2m

KS13



Κωδικός
530044

KDS.**Μετροταινία 3,5m**

JM19-35



Κωδικός
562632

KDS.**Μετροταινία 5,5m**

JM19-55



Κωδικός
552503

KDS.**Μετροταινία 5,5m**

GT25-55



Κωδικός
562656

KDS.**Μετροταινία 5,5m**κλίμακα σε εκατοστά & ίντσες
JM19-55YMEB BP

Κωδικός
ME5519J

KDS.**Μετροταινία 7,5m**

GT25-75



Κωδικός
562663

KDS.**Μετροταινία 5,5m**

GGEVO-25-55



Κωδικός
530259

KDS.**Μετροταινία 7,5m**

GGEVO-25-75



Κωδικός
530310

KDS.**Μετροταινία 7,5m**GT27-75 διπλής όψης - τριπλή
επίστρωση - inox ελατήριο - 4
περτσίνια

Japan



Κωδικός Τύπος
GT27-75 27mm

KDS.**Μετροταινία 8m** INOX

SS25-80



Κωδικός Τύπος
SS2580VBG 25mm

KDS.**Μετροταινία 10m**

ZS25-10



Κωδικός Τύπος
SME10 25mm

KDS.**Μετροταινίες**

KACLONG 10



Κωδικός Τύπος
KL10-20 10mmX20m
KL10-30 10mmX30m

KDS.

Αυτοκόλλητες μεζούρες 13mm

δεξιές



Κωδικός	Τύπος
562380	1 μέτρο
562397	2 μέτρα
510190	5 μέτρα

KDS

Αυτοκόλλητες μεζούρες 13mm

αριστερές



Κωδικός	Τύπος
TAIN213L	2 μέτρα
TAIN513L	5 μέτρα

KDS

Αυτοκόλλητες μεζούρες 13mm

μεσαίες



Κωδικός	Τύπος
TAIN513C	5 μέτρα

KDS

Ρίγες (Πασέτα) INOX



Κωδικός	Τύπος
SSL1000	-->
SSL1500	15cm
SSL300	30cm
539726	60cm
	1m

KDS

Μετροταινία PVC



Κωδικός	Τύπος
24505	50m

Kapriol

Γωνίες σιδηρουργού

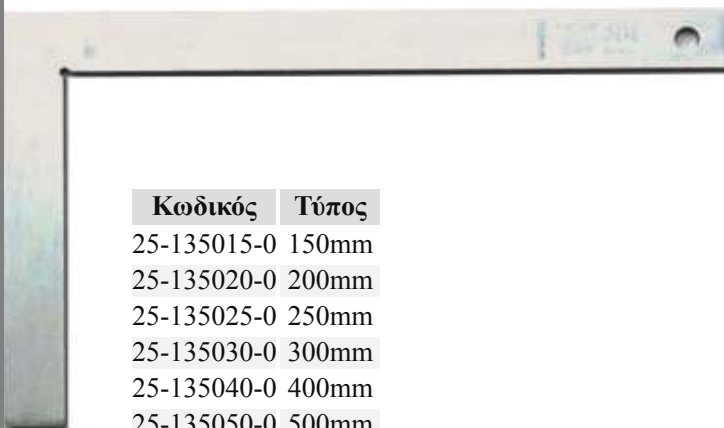

Κωδικός	Τύπος
25-135015-0	150mm
25-135020-0	200mm
25-135025-0	250mm
25-135030-0	300mm
25-135040-0	400mm
25-135050-0	500mm
25-135060-0	600mm
25-135080-0	800mm
25-135010-0	1000mm



Γωνίες σιδηρουργού με πατούρα



Κωδικός	Τύπος
46110150	25-136015-0 150mm
46110200	25-136020-0 200mm
46110250	25-136025-0 250mm
46110300	25-136030-0 300mm
46110400	25-136040-0 400mm
46110500	25-136050-0 500mm
46110600	25-136060-0 600mm
46110800	25-136080-0 800mm
461101000	25-136010-0 1000mm



Οδόμετρο αναδιπλούμενο

WM-10KDX

Με πενταψήφιο μηχανικό μετρητή (4 ακέραια + 1 δεκαδικό).

Μετράει μέχρι 9999,9 μέτρα.

Κατασκευή από αλουμίνιο.

Συνοδεύεται με θήκη μεταφοράς.



Κωδικός	Τύπος
520984	104cm

KDS



Παχύμετρο

COLUMBUS



Κωδικός **Τύπος**
40029 120mm



Παχύμετρα

INOX



Κωδικός **Τύπος**
0188501 150mm
0184505 200mm
0184508 300mm



Παχύμετρο

INOX



Κωδικός **Τύπος**
180015 150mm



Παχύμετρο ρολόι

INOX



Κωδικός **Τύπος**
25-185015-9 150mm



Παχύμετρο σημαδέματος

INOX



Κωδικός **Τύπος**
0322501 200mm



Μικρόμετρα

INOX



Κωδικός **Τύπος**
0800501 25-50mm
0800501 50-75mm



Φύλλερ



Κωδικός	Τύπος
25-197013-0	13 τεμαχίων
25-199020-0	20 τεμαχίων
25-204126-0	26 τεμαχίων
25-199120-0	20 τεμ. 0,05-1mm 200mm
25-199130-0	20 τεμ. 0,05-1mm 300mm



Σπειρόμετρο



Κωδικός	Τύπος
25-209148-0	48 φύλλα
25-208058-9	58 φύλλα



Σετ όργανα μέτρησης



Κωδικός
5096



Γωνία Στέλλα



Κωδικός Τύπος
46100200 200mm



Μοιρογνομόνια



Κωδικός Τύπος
25-148015-0 150mm
45660150200 200mm



Μοιρογνομόνιο



Κωδικός Τύπος
G012-03-145 195mm



Εξωτερικά κουμπάσα



Κωδικός Τύπος
25-173015-0 150mm
25-173017-0 175mm
25-173020-0 200mm
25-173025-0 250mm



Εσωτερικά κουμπάσα



Κωδικός Τύπος
25-172015-0 150mm
25-172017-0 175mm
25-172020-0 200mm
25-172025-0 250mm



Διαβήτες



Κωδικός Τύπος
25-168515-0 150mm
47209175 175mm
25-171017-9 175mm
με ρύθμιση
25-168525-0 250mm
25-168530-0 300mm





Εξολκείας μηχανικών με τρία σκέλη εξωτερικός
Μέγιστο βάθος: 147mm



Κωδικός Τύπος
66625 7-140mm

FORCE

Εξολκείας μηχανικών με τρία σκέλη εσωτερικός
Μέγιστο βάθος: 140mm



Κωδικός Τύπος
66624 23-130mm

FORCE

Εξολκείς με δύο σκέλη εσωτερικοί - εξωτερικοί



Κωδικός Τύπος
6590103 3"
6590104 4"
6590106 6"
6590108 8"

FORCE

Εξολκείς με τρία σκέλη εσωτερικοί - εξωτερικοί





Κωδικός Τύπος
6590203 3"
6590204 4"
6590206 6"
6590208 8"

FORCE

Εξολκείς δίποδοι





Κωδικός  
36/1 10-55mm 40mm
36/2 10-75mm 65mm

BUCU
Made in Germany

Εξολκείς τρίποδοι





Κωδικός  
37/1 10-55mm 40mm
37/2 10-75mm 65mm

BUCU
Made in Germany

Εξολκείς δίποδοι





Κωδικός  
28/1 20-170mm 130mm
28/2 20-230mm 200mm

BUCU
Made in Germany

Εξολκείς τρίποδοι



Κωδικός  
29/1 20-170mm 130mm
29/2 20-230mm 200mm

BUCU
Made in Germany



Εξολκείς δίποδοι



Κωδικός

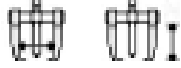

20/1	20-150mm	80mm
20/2	40-200mm	130mm

Εξολκείς τρίποδοι



Κωδικός

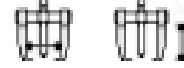

21/1	20-150mm	80mm
21/2	40-200mm	130mm

Εξολκείας δίποδος



Κωδικός Τύπος

65910	40-90mm
-------	---------



Εξολκείς δίποδοι

Κωδικός

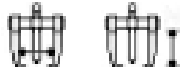

22/01	15-85mm	85mm
22/0	20-120mm	120mm
22/1	20-165mm	145mm
22/2	35-230mm	220mm
22/3	50-300mm	270mm
22/4	50-400mm	400mm
22/5	50-500mm	500mm

Εξολκείς τρίποδοι

Κωδικός

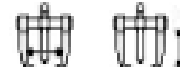

23/01	15-85mm	85mm
23/0	20-120mm	120mm
23/1	20-165mm	145mm
23/2	35-230mm	220mm
23/3	50-300mm	270mm
23/4	50-400mm	400mm
23/5	50-500mm	500mm

Εξολκείς μηχανικών με τρία σκέλη εξωτερικοί



Κωδικός Τύπος

65910090	90mm
65910130	130mm
65910160	160mm
65910200	200mm
65910250	250mm

Εξολκείς δίποδοι εξωτερικοί

Κωδικός



16/1	25-80mm	100mm	70-130mm
16/1A	25-130mm	100mm	80-180mm
16/2	50-160mm	150mm	105-220mm
16/2A	60-200mm	150mm	120-270mm
16/3	80-250mm	200mm	160-330mm
16/3A	80-350mm	200mm	160-420mm
16/4	110-520mm	200mm	195-600mm

Πόδια για εξολκείς τεμάχιο

Κωδικός



16A-200	200mm
16A-300	300mm
16A-400	400mm

Δίποδο σετ εξολκείων



Κωδικός



S16/0A 130mm 100-200-250mm
S16/2AS 200mm 150-300mm

Made in Germany

Τρίποδο σετ εξολκείων



Κωδικός



S17/0A 130mm 100-200-250mm

Made in Germany

Εξολκείς ακρόμπαρων

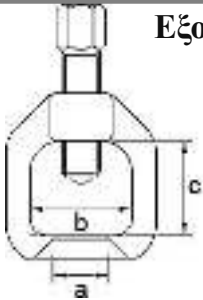

Κωδικός	A	B	C
180/2	18mm	37mm	37mm
180/3	23mm	45mm	45mm
180/4	29mm	55mm	60mm
180/5	39mm	70mm	80mm

Made in Germany

Εξολκείς ακρόμπαρων



Κωδικός	Τύπος
628E18	18mm
628E23	23mm
628E29	29mm
628E40	40mm
628E46	46mm

Εξολκείας ακρόμπαρων



Κωδικός	Τύπος
183/1	Ø22mm

Made in Germany

Εξολκείας ακρόμπαρων



Κωδικός	Τύπος
185/1	12-50mm
185/2	60-80mm

Made in Germany

Εξολκείας ακρόμπαρων



Κωδικός	Τύπος
62802	Ø20mm

Εξολκείας ακρόμπαρων



Κωδικός	Τύπος
62805	Ø20mm

Εξολκείας ακρόμπαρων

Υψος σύσφιξης 20-50mm



Κωδικός	Τύπος
62801	19mm



Καρυδάκια εξολκείς μπουζονιών

Κωδικός	Καρέ	Τύπος	Μήκος
81805	3/8	5mm	60mm
81806	1/2	6mm	60mm
81807	1/2	7mm	60mm
81808	1/2	8mm	60mm
81810	1/2	10mm	68mm
81812	1/2	12mm	68mm
81814	1/2	14mm	68mm



Καρυδάκια εξολκείς μπουζονιών

Κωδικός	Μήκος
75/6	6mm
75/8	8mm
75/10	10mm
75/12	12mm



Εξολκείας μπουζονιών



Κωδικός	Τύπος
71/1	Ø4-13mm



Εξολκείας μπουζονιών



Κωδικός	Τύπος
74	Ø4-19mm



Εξολκείας αδρανείας



Κωδικός
54/1



Εξολκείας αδρανείας



Κωδικός
54/2



Κόφτες παξιμαδιών



Κωδικός	Μήκος
220/1	4-10mm
220/2	10-18mm
220/3	18-27mm



Πηρούνες εξολκείων



Κωδικός	Άνοιγμα
190/1	18mm
190/2	23mm
190/3	29mm



Λεβιέδες ελαστικών



Κωδικός	Τύπος	Γόνατο	Κωδικός	Τύπος
750200	200mm 162gr		750380B	380mm 382gr
750300	300mm 370gr		750525B	525mm 800gr
750380	380mm 556gr		750650B	650mm 1160gr
750500	500mm 732gr			
750650	650mm 1160gr			



Εξολκείας ρουλεμάν

Κωδικός	Τύπος
50/02	5-6mm
50/01	6-8mm
50/0	8-12mm
50/1	12-16mm
50/2	16-20mm
50/3	20-27mm
50/3A	24-30mm
50/4	27-36mm
50/5	36-46mm
50/6	46-58mm
50/7	58-70mm
50/8	70-100mm



Γέφυρα πιάτων ρουλεμάν

Κωδικός	Τύπος
62/0	45-110mm 110mm 60/0, 61/0
62/1	55-140mm 155mm 60/1, 61/1
62/2	45-110mm 110mm 60/2, 61/2
62/3	55-140mm 155mm 60/3, 61/3
62/4	45-110mm 110mm 60/4, 61/4



Πιάτα για ρουλεμάν

Κωδικός	Τύπος
60/0	5-60mm
60/1	12-75mm
60/2	22-115mm
60/3	30-155mm
60/4	40-280mm



Εξολκείας ρουλεμάν επίπεδος

Κωδικός	Εύρος	Βίδα	Οπή
666050	30-50mm	3/8"x24x125mm	3/8"x16t
666075	50-75mm	1/2"x20x135mm	3/8"x16t
666105	75-105mm	1/2"x16x165mm	5/8"x18t
666150	105-150mm	3/4"x19x260mm	14,6x5/8"x11t



Εξολκείας σεντ επίπεδος

- 4 προεκτάσεις εξάγωνες με σπείρωμα 14mm x 102mm
- 4 προεκτάσεις εξάγωνες με σπείρωμα 17mm x 127mm
- 1 κοχλίας πίεσης 175mm x 9/16"
- Γέφυρα
 - Ικανότητα:
 - 30-50mm
 - 50-75mm



Κωδικός
66610



Εξολκείας ρουλεμάν οπής

Κωδικός Τύπος
66619 12-38mm 1/2"-1 1/2" 920gr



Μαγνητική βάση ωρολογιού

Βάρος: 1370gr
Ελκτική δύναμη: 80kg

Κωδικός
891B01



Ρολόι γράφτη

Εύρος: 0-8mm
Κλίμακα: 0,01mm

Κωδικός Τύπος
891A01 0-8mm



Εξολκείς ελατηρίων



Κωδικός	Τύπος
909/1	12-75mm
909/2	22-115mm
909/3	30-155mm



Εξολκείς ελατηρίων ζεύγος



Κωδικός	Τύπος
627270	270mm
627370	370mm



Εξολκείς ελατηρίων

Υψος: 240mm



Κωδικός	Τύπος
910/K	110-180mm



Γέφυρες εσωτερικών εξολκείων



Κωδικός	Τύπος
55/1	
55/2	
55/3	



Ανάστροφα κολαούζα σετ



Κωδικός	Τύπος
4709003	5 τεμάχια
4709013	6 τεμάχια



Εξολκείας - ανάστροφο κολαούζο



Κωδικός	Τύπος
4700063	No6



Εξολκείς - κολαούζα σετ



Κωδικός	Τύπος
4719003	5 τεμάχια



Εξολκείς - κολαούζα



Κωδικός	Τύπος
4710013	N1
4710023	N2
4710033	N3
4710043	N4
4710053	N5
4710063	N6



Σφιγκτήρες ελατηρίων εμβόλων



Κωδικός	Τύπος
6203125	Ø53-125mm 3"
6203175	Ø90-175mm 3"
6204175	Ø90-175mm 4"

Σφιγκτήρες ελατηρίων εμβόλων



Κωδικός	Τύπος
23-115001-0	No 0
23-115002-0	No 1
23-115004-0	No 2
23-115005-0	No 2A
23-115006-0	No 3

Εξολκείας βαλβίδων



Κωδικός	Τύπος
62104	

Εξολκείας βαλβίδων



Κωδικός	Τύπος
116029	70-225X290

Τραβηχτήρια σύρματος (καρκίνου)



Κωδικός	Τύπος
9200013	1-3mm
9200014	1-4mm
9200015	1-5mm
9200018	1-8mm
30-561012-0	1-12mm

Τραβηχτήρια σύρματος νέου τύπου



Κωδικός	Τύπος
30-560001-0	1-5mm 500kg
30-560006-0	3-9mm 1000kg
30-560016-0	4-12mm 1700kg
30-560050-0	6-18mm 3000kg

Βεντούζες λείανσης βαλβίδων αυτοκινήτου



Κωδικός	Τύπος
1182020	23-126520-0 Ø20
1182025	23-126525-0 Ø25
1182030	23-126530-0 Ø30
1182037	23-126537-0 Ø37
23-127000-0	Λεβιές

Εξολκείας βολάν μοτο



Κωδικός	Τύπος
9Y0186	M30x1,5

Σετ εξολκείας αδρανείας

Κωδικός
665B

FORCE

Σετ εξολκείας αδρανείας

Κωδικός
664

FORCE

Σετ εξολκείας αδράνειας και γέφυρα

Γέφυρα με εύρος 125mm
Εξολκείς τρύπας
Ø8-11mm
Ø12-17mm
Ø18-23mm
Ø24-29mm
Ø30-34mm
Αντάπτορες
M6 M8 M10



Κωδικός Τύπος
910T1

FORCE

Εξολκείς τρύπας για ρουλεμάν

Κωδικός	Τύπος
910T1-R0811	8-11mm
910T1-R1217	12-17mm
910T1-R1823	18-23mm
910T1-R2429	24-29mm
910T1-R3034	30-34mm

FORCE

Σετ εξολκείας υδραυλικός

Κωδικός
66622

FORCE

Σετ συμπιεστές ελατηρίων αμορτισέρ

Κωδικός	Τύπος
908T5	Ø80-Ø115mm Ø110-Ø150mm Ø140-Ø195mm

FORCE

Σετ εξολκείας υδραυλικός

Υδραυλική σφύρα:
Ø37,7X160mmX16t
Διαχωριστής Ø75-105mm
2 ράβδοι 8"x1,75
2 προεκτάσεις 8"x1,75
Φωλιά
Αντάπτορας Ø1"x30mm



Κωδικός
66601

FORCE

Συμπιεσόμετρο αερίου κυλίνδρων

Για βενζινοκίνητα
Με ταχυσύνδεσμο και
βαλβίδα απελευθέρωσης
4 αντάπτορες: 10x1,00 -
12x1,25 - 14x1,25 - 18x1,5
Κλίμακα: 0-300psi,
0-21kg/cm²



Κωδικός
908G1

FORCE

Συμπιεσόμετρο για κινητήρες Diesel

- ο Με ταχυσύνδεσμο και βαλβίδα απελευθέρωσης
- ο Εύκαμπτος σωλήνας 355mm
- ο 5 αντάπτορες προθερμαντήρων:
10x1,00x119mm - 10x1,25x735mm - 10x1,75x114mm
12x1,25x54mm - 14x1,25x72mm
- ο 3 ομοιώματα μπεκ ψεκασμού: 20x1,50 - 24x2,00x64mm
- ο Ομοίωμα μπεκ ψεκασμού 114mm
- ο Γόνατο 90° πλάκα - σφυγκτήρας - σετ ροδέλες
- ο Διπλή κλίμακα: 0-1000psi - 0-70bar
- ο Κατάλληλο για: FORD ROVER MERCEDES TOYOTA VW NISSAN BMW RENAULT MAZDA MITSUBUSHI PEUGEOT OPEN FIAT CITROEN LAND ROVER SEAT LEYLAND DAF VOLVO VAUXHALL DACIA DAIHATSU ISUZU

Κωδικός

913G1

**FORCE****Σετ φρέζες καθαρισμού εδρών μπέκ Diesel****Κωδικός Τύπος**

906G1

FORCE**Κιτ εξαέρωσης φρένων****Κωδικός Τύπος**

908G8

FORCE**Ακουστικά μηχανών****Κωδικός Τύπος**

9G2204 200gr

FORCE**Πένσα ελατηρίων για ταμπούρα****Κωδικός Τύπος**

9B0101

FORCE**Πένσα ελατηρίων για ταμπούρα****Κωδικός Τύπος**

9B0105

FORCE**Πλατυτσίμπιδο ασφαλειών χωρίς τρύπες****Κωδικός Τύπος**

9T0105

FORCE

Πρέσα πείρων αλυσίδας

Για αλυσίδες 5/8" - 3/4" - 1"



Κωδικός Τύπος
9Y0135 225mm 720gr

**Εργαλείο τοποθέτησης ρουλεμάν & τσιμουχών**

- ο Αλουμινένιο σώμα
- ο Περιστρεφόμενη λαβή και δυνατότητα σύσφιξης της επιθυμητής διαμέτρου
- ο Ικανότητα τοποθέτησης: 18,5-89mm - 0,72-3,5"



Κωδικός
9U0301

**Εξολκέας βολάν μηχανής**

- ο Διαστάσεις: M27x1,0
- ο Κατάλληλος για: HONDA, SUZUKI, YAMAHA, KAWASAKI, KTM
- ο Βάρος: 250gr



Κωδικός
9Y0181

**Σετ εξωλκέων βολάν ^{NEO}**

Yamaha, Suzuki, Honda, Bosch, Ducan, Glera, Sam, Cagiva, Sfera, Kymco, MBK, Peugeot, Kimoo, Motoplatt, Kawasaki, Kokusan, Minaelli, Ducati κλπ.

85mmL (14x1,5-16x1,5-18x1,5)
65mmL (19x1-28x1,5-
20x1&27x1,25-22x1&25x1,5-
22x1,5&26x1,5-24x1&27x1-
26x1&28x1)



Κωδικός Τύπος
909Y1 10 τεμάχια

**Πένσες διακοπής ροής κολάρων 3 τεμάχια**

Κωδικός Τύπος
903G12 10-15-24mm

**Εργαλείο κλειδώματος εκκεντροφόρου**

Volkswagen, Seat και Skoda Diesel, Rover και Land Rover Diesel, Renault και Fiat με διπλό έκκεντρο, Ford Zetec, Citroen και Peugeot κλπ.

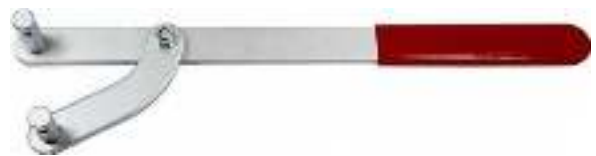

Κωδικός Τύπος
9G0606

**Εργαλείο εξαγωγής ράουλου δυναμού Bosch**

Audi, BMW, Ford, Seat, Mercedes, Skoda, Volkswagen, Porsche κλπ.



Κωδικός Τύπος
674 M10

**Κλειδί για καπάκι δεξαμενής καυσίμου ^{NEO}**

Ρυθμιζόμενο



Κωδικός Τύπος
9G0713 3/8" - 122-199 mm



Σετ επιδιόρθωσης ελαστικών

- ο Εργαλείο με αξονάκι οπής για τοποθέτηση κορδονιού
- ο Εργαλείο με αξονάκι λίμας για τον καθαρισμό της οπής του ελαστικού
- ο Ανταλλακτικό αξονάκι με οπή
- ο Ανταλλακτικό αξονάκι με λίμα
- ο Σετ 5 τεμάχια κορδόνια επισκευής

**Κωδικός**

904T4

FORCE**Ανταλλακτικά κορδόνια επισκευής ελαστικών**

5 τεμάχια

**Κωδικός**

904T4-P

FORCE**Πιστόλι αέρος ελαστικών**

Μήκος: 300mm

**Κωδικός Τύπος**

9T0401 200psi

FORCE**Δοκιμαστικό πίεσης ελαστικών****Κωδικός Τύπος**

9T0405B 10-150psi

FORCE**Πιστόλια αέρος**

Πίεση λειτουργίας 5,5 έως 8,5 bar
Σπείρωμα εισόδου 1/4" θηλυκό

**Κωδικός Τύπος**

9U0202 100mm (κοντό)

9U0203 340mm (μακρύ)

FORCE**Σταυρός επιβατικών αυτοκινήτων**

πτυσσόμενος



17mm-19mm-21mm-1/2"

Κωδικός Τύπος

681400 400mm 1490gr

FORCE**Πυκνόμετρο δοκιμής αντιψυκτικού****Κωδικός Τύπος**

9G4001

FORCE**Σετ εξαγωγής φαρμένων παξιμαδιών - μπουλωνιών**

8-9-10-11-12-13-14-15-16-17-18-19mm

**Κωδικός Τύπος**

912U8 σετ 12 τεμαχίων

FORCE

**Δοκιμαστικό αυτοκινήτων
6-24V**



Κωδικός
22-163000-0



Tester οχημάτων



Κωδικός Τύπος
88427 3-48Vdc



Tester τάσης 6-400V AC/DC

Led με ένδειξη 6-12-24-50-120-220-400V



Κωδικός Τύπος
88408



Κρουστικό κατσαβίδι με αρσενικό καρέ 1/2"
*χρειάζεται τον αντάπτορα 81045 για τις μύτες 5/16"



Κωδικός Τύπος
8174 1/2"



Κρουστικό κατσαβίδι σε κασετίνα
Περιέχει 4 μύτες 5/16"



Κωδικός Τύπος
5064 5/16"



Σφυροκατσάβιδο σετ

9mm 11mm PH2 PH3 PZ2 PZ3 T25 T30 T40 T45 T50



Κωδικός Τύπος
5171 1/2" 17 τεμάχια



Μύτες σφυροκατσάβιδων Torx 5/16"



Κωδικός Τύπος
278202 T25X32
278212 T27X32
278222 T30X32
278232 T40X32
278242 T45X32
278252 T50X32
278272 T55X32



Μύτες σφυροκατσάβιδων Phillips 5/16"



Κωδικός Τύπος
278022 PH2X32
278032 PH3X32
278042 PH4X32



Μύτες σφυροκατσάβιδων Pozidriv 5/16"



Κωδικός Τύπος
278122 PZ2X32
278132 PZ3X32
278142 PZ4X32



Μύτες σφυροκατσάβιδων ίσιες 5/16"



Κωδικός Τύπος
278322 8X1,6
278332 10X1,6
278342 12X2



Περσιναδόρος



Κωδικός Τύπος
HR-702 2,4 - 4,8 mm



Περσιναδόρος



Κωδικός Τύπος
HR-705 2,4 - 4,8 mm



Περσιναδόρος Β/Τ



Κωδικός Τύπος
THR-11E 2,4 - 4,8 mm



Επαγγελματικός περσιναδόρος



Κωδικός Τύπος
HR-730 2,4 - 6,4 mm



Περσιναδόρος για περσίνα με σπείρωμα



Κωδικός Τύπος
HN-02 M4-M10



Περσιναδόρος για περσίνα με σπείρωμα



Κωδικός Τύπος
678N320 M4-M10



Περσιναδόρος για περσίνα με σπείρωμα



Κωδικός Τύπος
5861 M3-M6



Περσιναδόρος χειρός

για περσίνα με σπείρωμα



Αλουμίνιο: M3x0,50-M8x1,25
Χάλυβας: M3x0,50-M6x1,00
Inox: M3x0,50-M5x0,80

Κωδικός Τύπος
678N260 250mm 640gr



Περσιναδόροι αέρος

Κωδικός	Τύπος	Κωδικός	Τύπος
AR-5M	2,4-4,8mm	Ανταλλακτικά AR-7L:	
AR-7L	2,4-6,4mm	AR-7L020	
Ανταλλακτικά AR-5M:		AR-7L021	
AR-5M020		AR-7L0211	
AR-5M030		AR-7L0212	
AR-5M039		AR-7L0213	
		AR-7L030	
		AR-7L031	
		AR-7L039	



Περσιναδόρος αέρος

για περσίνα με πάσο



Κωδικός Τύπος
SRC-SN10 M5-M6-M8-M10-M12



**Περτσίνια αλουμινίου**

↓Μήκος↓ 3mm 4mm 4,8mm 6mm

6				
8				
10				
12				
14				
16				
18				
20				
25				
26				
30				

**Περτσίνια αλουμινίου φαρδιά**

Κωδικός Διαστάσεις

PAF0410	4X10
PAF0412	4X12
PAF0425	4X25
PAF4810	4,8X10
PAF4812	4,8X12
PAF4816	4,8X16
PAF4820	4,8X20
PAF4825	4,8X25

**Περτσίνια σιδήρου με πάσο**

Κωδικός	Πάσο
PS4007	M4x0,7
PS5008	M5x0,8
PS6010	M6x1,0
PS8015	M8x1,25
PS1015	M10x1,5
PS1217	M12x1,75

**Αυτόματος κεντραδόρος**Κωδικός
5096P2**Κεντραδόροι (πόντες)**

Κωδικός	Τύπος
4301000	100mm
4301200	120mm

**Ζουμπάδες**

Κωδικός	Τύπος
4500020	2mm
4500030	3mm
4500040	4mm
4500050	5mm
4500060	6mm
4500070	7mm
4500080	8mm
4500100	10mm

**Ζουμπάδες σελ**

Κωδικός	Τύπος
4251700	3-10mm

**Σελ ζουμπάδες**2x140mm
3x150mm
4x190mm
5x200mm
6x210mm
8x215mm

Κωδικός	Τύπος
50613	6 τεμαχίων

**Ζουμπάς ρομπότ**Κωδικός
4451365

Χτυπητά γράμματα Λατινικά

Κωδικός	Τύπος
943002	2mm
943003	3mm
943004	4mm
943005	5mm
943006	6mm
943008	8mm
9430010	10mm

**Χτυπητά γράμματα Ελληνικά**

Κωδικός	Τύπος
943202	2mm
943203	3mm
943204	4mm
943205	5mm
943206	6mm
943208	8mm
9432010	10mm

**Στένσιλ με Ελληνική αλφάβητο**

Κωδικός	Τύπος
30-540004-0	40mm
30-540006-0	60mm
30-540008-0	80mm
30-540012-0	120mm

**Στένσιλ με Λατινική αλφάβητο**

Κωδικός	Τύπος
30-541004-0	40mm
30-541006-0	60mm
30-541008-0	80mm
30-541012-0	120mm

**Χτυπητοί αριθμοί**

Κωδικός	Τύπος
30-535002-0	2mm
30-535003-0	3mm
30-535004-0	4mm
30-535005-0	5mm
30-535006-0	6mm
30-535008-0	8mm
30-535010-0	10mm
30-535012-0	12mm

**Στένσιλ με αριθμούς**

Κωδικός	Τύπος
30-542004-0	40mm
30-542006-0	60mm
30-542008-0	80mm
30-542012-0	120mm



**Ξύστρα φλαντζών****Κωδικός**

46326009

RENNSTIG

Ξύστρα φλαντζών**Κωδικός Τύπος**

905M2P3 25x160mm

Σγκρόπιες

Κωδικός	Τύπος	Κωδικός	Τύπος	Κωδικός	Τύπος	Κωδικός	Τύπος
30-243001-0	1mm	30-243014-0	14mm	7650027	27mm	30-240040-0	40mm
30-243002-0	2mm	30-243015-0	15mm	7650028	28mm	7655041	41mm
30-243003-0	3mm	30-243016-0	16mm	30-240029-0	29mm	7655042	42mm
30-243004-0	4mm	30-243017-0	17mm	30-240030-0	30mm	7655043	43mm
30-243005-0	5mm	30-243018-0	18mm	7650031	31mm	7655044	44mm
30-243006-0	6mm	30-243019-0	19mm	7650032	32mm	7655045	45mm
30-243007-0	7mm	30-243020-0	20mm	7650033	33mm	30-240046-0	46mm
30-243008-0	8mm	30-243021-0	21mm	7650034	34mm	7655047	47mm
30-243009-0	9mm	30-243022-0	22mm	7650035	35mm	7655048	48mm
30-243010-0	10mm	30-243023-0	23mm	7655036	36mm	7655049	49mm
30-243011-0	11mm	30-243024-0	24mm	7655037	37mm	7655050	50mm
30-243012-0	12mm	30-243025-0	25mm	7655038	38mm		
30-243013-0	13mm	7650026	26mm	7655039	39mm		

**Φλαντζοκόφτες****Κωδικός Τύπος**

28-230020-0 200mm

28-230030-0 300mm

28-230040-0 400mm

28-230060-0 600mm

28-230080-0 800mm

Σετ κολαούζα

Κωδικός	Τύπος	Κωδικός	Τύπος	Κωδικός	Τύπος	Κωδικός	Τύπος
02040	2X0,40	12125	12X1,25	18125	18X1,25	30350	30X3,50
25045	2,5X0,45	12150	12X1,50	18150	18X1,50	32150	32X1,50
03050	3X0,50	12175	12X1,75	18175	18X1,75	32350	32X3,50
04070	4X0,70	13075	13X0,75	18200	18X2,00	33200	33X2,00
05080	5X0,80	13100	13X1,00	18250	18X2,50	33350	33X3,50
06075	6X0,75	13125	13X1,25	20150	20X1,50	34150	34X1,50
06100	6X1,00	13150	13X1,50	20200	20X2,00	36150	36X1,50
07100	7X1,00	13175	13X1,75	20250	20X2,50	36200	36X2,00
08075	8X0,75	14100	14X1,00	22150	22X1,50	36400	36X4,00
08100	8X1,00	14125	14X1,25	22200	22X2,00	38150	38X1,50
08125	8X1,25	14150	14X1,50	22250	22X2,50	39400	39X4,00
08150	8X1,50	14175	14X1,75	24150	24X1,50	40150	40X1,50
09100	9X1,00	14200	14X2,00	24200	24X2,00	42150	42X1,50
09125	9X1,25	15100	15X1,00	24300	24X3,00	42450	42X4,50
09150	9X1,50	15125	15X1,25	26150	26X1,50		
10100	10X1,00	15150	15X1,50	26300	26X3,00		
10125	10X1,25	16100	16X1,00	27150	27X1,50		
10150	10X1,50	16125	16X1,25	27200	27X2,00		
11100	11X1,00	16150	16X1,50	27300	27X3,00		
11125	11X1,25	16175	16X1,75	28150	28X1,50		
11150	11X1,50	16200	16X2,00	30150	30X1,50		
12100	12X1,00	18100	18X1,00	30200	30X2,00		



Σετ κολαούζα και φιλιέρες (μετρικό)



Κωδικός	Τύπος
725	M3-M10
726	M4-M12

Σετ κολαούζα **αριστερόστροφα**

Κωδικός	Τύπος
CL05080	5X0,80
CL06100	6X1,00
CL08125	8X1,25
CL10100	10X1,00
CL10150	10X1,50
CL10175	10X1,75
CL12125	12X1,25
CL12150	12X1,50
CL12175	12X1,75
CL14150	14X1,50
CL14200	14X2,00
CL16150	16X1,50
CL16200	16X2,00
CL18150	18X1,50
CL18250	18X2,50
CL20150	20X1,50
CL20250	20X2,50
CL22150	22X1,50
CL22250	22X2,50
CL24150	24X1,50
CL24200	24X2,00
CL24300	24X3,00





Σετ κολαούζα ίντζας UNC - BSW



Κωδικός	Τύπος	Κωδικός	Τύπος
CUNC03240	1/8"X40	CUNC14012	9/16"X12
CUNC04032	5/32"X32	CUNC15811	5/8"X11
CUNC04724	3/16"X24	CUNC19010	3/4"X10
CUNC06320	1/4"X20	CUNC22209	7/8"X9
CUNC07918	5/16"X18	CUNC28608	1"X8
CUNC09516	3/8"X16	CUNC28607	1 1/8"X7
CUNC11014	7/16"X14	CUNC31707	1 1/4"X7
CUNC12712	1/2"X12	CUNC38106	1 1/2"X6
CUNC12713	1/2"X13		



Σετ κολαούζα ίντζας ψιλόπασα UNF



Κωδικός	Τύπος	Κωδικός	Τύπος
CUNF04732	3/16"X32	CUNF12722	1/2"X22
CUNF06328	1/4"X28	CUNF14016	9/16"X16
CUNF07924	5/16"X24	CUNF14018	9/16"X18
CUNF07932	5/16"X32	CUNF15816	5/8"X16
CUNF09516	3/8"X18	CUNF15811	5/8"X18
CUNF09520	3/8"X20	CUNF19016	3/4"X16
CUNF09522	3/8"X22	CUNF22214	7/8"X14
CUNF09524	3/8"X24	CUNF25412	1"X12
CUNF09532	3/8"X32	CUNF25414	1"X14
CUNF11020	7/16"X20	CUNF28612	1 1/8"X12
CUNF12716	1/2"X16	CUNF31712	1 1/4"X12
CUNF12720	1/2"X20	CUNF38112	1 1/2"X12



Κολαούζο ίντζας UNC



Κωδικός	Τύπος	Κωδικός	Τύπος
75514	1/4"	75526	5/8"
75516	5/16"	75530	3/4"
75518	3/8"	75534	7/8"
75522	1/2"		



Κολαούζο ίντσας BSW



Κωδικός	Τύπος
71522	1/2"



Σετ κολαούζα σωλήνων ίντσας BSP



Κωδικός	Τύπος	Κωδικός	Τύπος
BSP03228	1/8"X28	BSP22214	7/8"X14
BSP06319	1/4"X19	BSP25411	1"X11
BSP09519	3/8"X19	BSP31711	1 1/4"X11
BSP12714	1/2"X14	BSP38111	1 1/2"X11
BSP15814	5/8"X14	BSP50811	2"X11
BSP19014	3/4"X14		



Κολαούζα σωλήνων κοντά εξάγωνα στη μέση BSP



Κωδικός	Τύπος
67871	1/4"
67872	3/8"
67873	1/2"
67874	3/4"
67875	1"



**Κολαούζο ελικοειδές 150mm**

Για φυσικό αέριο



Κωδικός	Τύπος
32036	M6X1,00

VÖLKEL**Κολαούζα παραγωγής για inox**

Κωδικός	Τύπος
35226	M3*0,50mm
35230	M4*0,70mm
35234	M5*0,80mm
35238	M6*1,00mm
35242	M8*1,25mm
35246	M10*1,50mm
35250	M12*1,75mm

VÖLKEL**Τρυπανοκολαούζα μακριά**

Τετράγωνο καρέ



Κωδικός	Τύπος
37026	M3*0,50mm
37030	M4*0,70mm
37034	M5*0,80mm
37038	M6*1,00mm
37042	M8*1,25mm
37046	M10*1,50mm
37050	M12*1,75mm

VÖLKEL**Ελικοειδή κολαούζα με λεπτό άξονα**

Κωδικός	Τύπος	Μήκος
38726	M3*0,50mm	56mm
38730	M4*0,70mm	63mm
38734	M5*0,80mm	70mm
38738	M6*1,00mm	80mm
38742	M8*1,25mm	90mm
38746	M10*1,50mm	100mm
38750	M12*1,75mm	110mm

VÖLKEL**Σετ τρυπανοκολαούζα με καρέ ¼"**

Κωδικός	Τύπος
67200	3-10mm

VÖLKEL**Τρυπανοκολαούζα με καρέ ¼"**

Κωδικός	Τύπος
67226	M3X0,5
67230	M4X0,7
67234	M5X0,8
67238	M6X1,0
67242	M8X1,25
67246	M10X1,5

VÖLKEL

Κολαούζα παραγωγής HSS



Κωδικός	Τύπος	Κωδικός	Τύπος
37516	M2*0,40mm	38550	M12*1,75mm
37522	M2,5*0,45mm	38554	M14*2mm
37526	M3*0,50mm	38558	M16*2mm
37528	M3,5*0,60mm	38562	M18*2,5mm
37530	M4*0,70mm	39540	M20*1,5mm
37534	M5*0,80mm	38566	M20*2,5mm
37538	M6*1,00mm	39545	M22*1,5mm
37540	M7*1,00mm	38570	M22*2,5mm
37542	M8*1,25mm	38574	M24*3mm
37546	M10*1,50mm		

Σετ κολαούζα **αριστερόστροφα**

Κωδικός	Τύπος
27026	M3*0,50mm
27030	M4*0,70mm
27034	M5*0,80mm
27038	M6*1,00mm
27042	M8*1,25mm
27046	M10*1,50mm
27050	M12*1,75mm
27054	M14*2,00mm
27058	M16*2,00mm
27062	M18*2,50mm
27066	M20*2,50mm



Κολαούζα κοντά εξάγωνο στη μέση

Κωδικός	Τύπος	Κωδικός	Τύπος	Κωδικός	Τύπος
67727	M12*1,00mm	67740	M15*1,00mm	67761	M20*1,50mm
67728	M12*1,25mm	67741	M15*1,50mm	67762	M20*2,00mm
67729	M12*1,50mm	67744	M16*1,00mm	67054	M20*2,50mm
67050	M12*1,75mm	67745	M16*1,25mm	67769	M22*1,50mm
67732	M13*1,00mm	67746	M16*1,50mm	67770	M22*2,00mm
67733	M13*1,50mm	67052	M16*2,00mm	67055	M22*2,50mm
67737	M14*1,25mm	67753	M18*1,50mm	67769	M24*1,50mm
67738	M14*1,50mm	67754	M18*2,00mm	67770	M24*2,00mm
67051	M14*2,00mm	67053	M18*2,50mm	67056	M24*3,00mm



Κολαούζα παραγωγής ψιλόπασα



Κωδικός	Τύπος
39411	8X1mm
39415	10X1mm
39416	10X1,25mm
39421	12X1,25
39422	12X1,5
39427	14X1,25
39428	14X1,5
39433	16X1,5
39436	18X1,5

Κολαούζα NPT



Κωδικός	Τύπος
63512	1/8"
63514	1/4"
63516	3/8"
63518	1/2"

Κολαούζα σωλήνος



Κωδικός	Τύπος
78412	1/8"
78514	1/4"
78414	1/4"
78516	3/8"
78416	3/8"
78518	1/2"
78418	1/2"
78422	3/4"

Κολαούζα ελικοειδή



Κωδικός	Τύπος
36230	M4*0,70mm
36242	M8*1,25mm

Φιλίερες Ø38 - Ø50

Κωδικός	Τύπος	Κωδικός	Τύπος	Κωδικός	Τύπος
CD02040	2X0,40	CD12100	12X1,00	CD22250	22X2,50
CD25045	2,5X0,45	CD12125	12X1,25	CD24150	24X1,50
CD025145	3X0,50	CD12150	12X1,50	CD24200	24X2,00
CD04070	4X0,70	CD12175	12X1,75	CD24300	24X3,00
CD05080	5X0,80	CD14100	14X1,00	CD26150	26X1,50
CD06075	6X0,75	CD14125	14X1,25	CD26300	26X3,00
CD06100	6X1,00	CD14150	14X1,50	CD27200	27X2,00
CD07100	7X1,00	CD14200	14X2,00	CD27300	27X3,00
CD08100	8X1,00	CD16100	16X1,00	CD28150	28X1,50
CD08125	8X1,25	CD16125	16X1,25	CD30150	30X1,50
CD08150	8X1,50	CD16150	16X1,50	CD30350	30X3,50
CD09100	9X1,00	CD16200	16X2,00	CD32150	32X1,50
CD09125	9X1,25	CD18150	18X1,50	CD32350	32X3,50
CD10100	10X1,00	CD18200	18X2,00	CD33150	33X1,50
CD10125	10X1,25	CD18250	18X2,50	CD34150	34X1,50
CD10150	10X1,50	CD20150	20X1,50	CD36150	36X1,50
CD11100	11X1,00	CD20200	20X2,00	CD36400	36X4,00
CD11125	11X1,25	CD20250	20X2,50	CD38150	38X1,50
CD11150	11X1,50	CD22150	22X1,50		



SKC

Φιλίερες

Κωδικός	Τύπος	Κωδικός	Τύπος
27430	4X0,7mm	27454	14X2,00mm
27438	6X1,00mm	26466	16X1,50mm
27442	8X1,25mm	27458	16X2,00mm
26436	10X1,00mm	26472	18X1,50mm
26438	10X1,25mm	26474	18X2,00mm
27446	10X1,50mm	27462	18X2,50mm
26446	12X1,25mm	26484	20X1,50mm
26448	12X1,50mm	26494	22X1,50mm Ø55
27450	12X1,75mm	26604	24X1,50mm Ø55
26456	14X1,50mm	26670	42X1,50mm Ø55



VOLKEL

Φιλίερες Ø38 - Ø50 αριστερόστροφες

Κωδικός	Τύπος	Κωδικός	Τύπος
CDL04070	4X0,70	CDL14150	14X1,50
CDL05080	5X0,80	CDL14200	14X2,00
CDL06100	6X1,00	CDL16150	16X1,50
CDL07100	7X1,00	CDL16200	16X2,00
CDL08100	8X1,00	CDL18150	18X1,50
CDL08125	8X1,25	CDL18250	18X2,50
CDL10100	10X1,00	CDL20150	20X1,50
CDL10125	10X1,25	CDL20250	20X2,50
CDL10150	10X1,50	CDL22150	22X1,50
CDL12125	12X1,25	CDL22250	22X2,50
CDL12150	12X1,50	CDL24150	24X1,50
CDL12175	12X1,75	CDL24300	24X3,00



SKC

**Φιλίερες ίντσας UNC Ø38 - Ø50**

Κωδικός	Τύπος	Κωδικός	Τύπος
DUNC03240	1/8"X40	DUNC14012	9/16"X12
DUNC04032	5/32"X32	DUNC15811	5/8"X11
DUNC04724	3/16"X24	DUNC19010	3/4"X10
DUNC06320	1/4"X20	DUNC22209	7/8"X9
DUNC07918	5/16"X18	DUNC28608	1"X8
DUNC09516	3/8"X16	DUNC28607	1 1/8"X7
DUNC11014	7/16"X14	DUNC31707	1 1/4"X7
DUNC12712	1/2"X12		
DUNC12713	1/2"X13		

**Φιλίερες ίντσας ψιλόπασες UNF Ø38 - Ø50**

Κωδικός	Τύπος	Κωδικός	Τύπος
DUNF04732	3/16"X32	DUNF15818	5/8"X18
DUNF06328	1/4"X28	DUNF19016	3/4"X16
DUNF07924	5/16"X24	DUNF22214	7/8"X14
DUNF09524	3/8"X24	DUNF25412	1"X12
DUNF11020	7/16"X20	DUNF25414	1"X14
DUNF12720	1/2"X20		
DUNF14018	9/16"X18		

**Φιλίερες σωλήνων σε ίντσες BSP Ø38 - Ø50**

Κωδικός	Τύπος	Κωδικός	Τύπος
DBSP03228	1/8"X28	DBSP22214	7/8"X14
DBSP06319	1/4"X19	DBSP25411	1"X11
DBSP09519	3/8"X19	DBSP31711	1 3/4"X11
DBSP12714	1/2"X14	DBSP38111	1 1/2"X11
DBSP15814	5/8"X14	DBSP50811	2"X11
DBSP19014	3/4"X14		

**Φιλίερες Ø25**

Κωδικός	Τύπος	Κωδικός	Τύπος
D2502040	2X0,40mm	D2508125	8X1,25mm
D25025045	2,5X0,45mm	D2509100	9X1,00mm
D2503050	3X0,50mm	D2509125	9X1,25mm
D2504070	4X0,70mm	D2510100	10X1,00mm
D2505080	5X0,80mm	D2512125	12X1,25mm
D2506075	6X0,75mm	D25121250	12X1,50mm
D2508100	8X1,00mm		

**Φιλίερες Ø25 αριστερόστροφες**

Κωδικός	Τύπος
DL2508100	8X1,00mm
DL2510100	10X1,00mm
DL2508125	8X1,25mm
DL2512125	12X1,25mm
DL25121250	12X1,50mm
DL25121275	12X1,75mm

**Φιλίερες ίντσας ψιλόπασες UNC Ø25**

Κωδικός	Τύπος
DUNC250403	5/32"X32
DUNC250472	3/16"X24
DUNC250632	1/4"X20
DUNC250951	3/8"X16
DUNC251101	7/16"X14



Μανέλες κολαούζων



Κωδικός	Τύπος
CMK00	No0 1/16"-1/4" M1-M6
CMK04	No4 1/16"-1/2" M3-M12
CMK05	No5 3/19"-1/2" M4-M12
CMK06	No6 1/4"-3/4" M6-M20
CMK07	No7 3/8"-1" M8-M25



Μανέλες κολαούζων



Κωδικός	Τύπος	Καρέ
13010	No 1	2-6,3mm
13015	No 1.1/2	2,1-8mm
13020	No 2	3-9mm
13030	No 3	4,9-12mm
13040	No 4	5,5-16mm
13050	No 5	7-20mm



Μανέλες κολαούζων ατσάλινες



Κωδικός	Τύπος
14010	No 1
14020	No 2
14030	No 3
14040	No 4
14050	No 5



Καστάνιες κολαούζων



Κωδικός	Τύπος
24-127001-0	M3-8
24-127002-0	M5-12



Καστάνιες κολαούζων μακριές



Κωδικός	Τύπος
24-129010-0	M3-M10 N10 300mm
24-129020-0	M5-M12 N20 300mm



Προεκτάσεις κολαούζων



Κωδικός	Τύπος
14534	M4
14549	M4,5-M6
14555	M9-M10
14562	M11
14570	M12
14580	M10
14590	M14-M16



Μανέλες φιλιέρας



Κωδικός	Τύπος
CMF254	1"
CMF381	1 1/2"
CMF508	2"
CMF636	2 1/2"



Μανέλες φιλιέρας



Κωδικός	Τύπος	Τύπος
15002	Ø20*5mm	M3-M4
15003	Ø20*7mm	M4,5-M6
15004	Ø25*9mm	M7-M9
15005	Ø30*11mm	M10-M11
15007	Ø38*14mm	M12-M14
15008	Ø45*14mm	M16-M20
15009	Ø45*18mm	M16-M20 BSW
DS50	Ø50mm	
DS55	Ø55mm	
DS65	Ø65mm	
15218	Ø105*22mm	Mf54-Mf63





Ελατήρια επιδιόρθωσης πάσων 1D

Κωδικός	Τύπος
07208	M5*0,80
07209	M6*1,00
07210	M7*1,00
07211	M8*1,25
07216	M10*1,25
07219	M10*1,50
07223	M12*1,25
07222	M12*1,50
07221	M12*1,75
07225	M14*2,00
07234	M16*2,00
07236	M18*2,50
07239	M20*2,50



VÖLKEL

Ελατήρια επιδιόρθωσης πάσων 1,5D

Κωδικός	Τύπος
07307	M4*0,70
07308	M5*0,80
07309	M6*1,00
07311	M8*1,25
07317	M10*1,00
07316	M10*1,25
07319	M10*1,50
07323	M12*1,25
07322	M12*1,50
07321	M12*1,75
07327	M14*1,25
07326	M14*1,50
07325	M14*2,00
07335	M16*1,50
07334	M16*2,00
07338	M18*1,50
07336	M18*2,50
07341	M20*1,50
07339	M20*2,50



VÖLKEL

Ελατήρια επιδιόρθωσης πάσων 2D

Κωδικός	Τύπος
07408	M5*0,80
07409	M6*1,00
07439	¼"
07411	M8*1,25
07416	M10*1,25
07419	M10*1,50
07423	M12*1,25
07422	M12*1,50
07421	M12*1,75
07427	M14*1,25
07426	M14*1,50
07425	M14*2,00
07435	M16*1,50
07434	M16*2,00
07438	M18*1,50
07436	M18*2,50
07441	M20*1,50
07439	M20*2,50



VÖLKEL

Λεβιές εισαγωγής ελατηρίου

Κωδικός	Τύπος
08008	M5*0,80 3
08009	M6*1,00 9
08011	M8*1,00 11
	M8*1,25 11
08013	M10*1,00 13
	M10*1,25 13
08015	M10*1,50 13
	M12*1,25 15
08017	M12*1,50 15
	M12*1,75 15
08016	M14*1,25 17
	M14*1,50 16
08018	M14*2,00 16
	M16*1,50 18
08021	M16*2,00 18
	M20*1,50 21
08021	M20*2,00 21
	M20*2,50 21



VÖLKEL

Κολαούζο επιδιόρθωσης σπειρωμάτων

Κωδικός	Τύπος	03021	M12*1,50	Κωδικός	Τύπος
03008	M5*0,80	Κωδικός	Τύπος	03036	M18*2,00
03009	M6*1,00	03020	M12*1,75	03035	M18*2,50
03012	M8*1,00	03029	M14*1,25	03040	M20*1,50
03011	M8*1,25	03028	M14*1,50	03039	M20*2,00
03017	M10*1,00	03027	M14*2,00	03038	M20*2,50
03016	M10*1,25	03034	M16*1,50		
03015	M10*1,50	03033	M16*2,00		
03022	M12*1,25	03037	M18*1,50		



VÖLKEL

Κιτ επιδιόρθωσης σπειρωμάτων 1,5D

VCOIL

Κωδικός	Τύπος	Κωδικός	Τύπος	Κωδικός	Τύπος
04007	M4*0,70	04022	M12*1,50	04036	M18*1,50
04009	M5*0,80	04021	M12*1,75	04035	M18*2,00
04010	M6*1,00	04030	M14*1,25	04034	M18*2,50
04013	M8*1,00	04029	M14*1,50	04039	M20*1,50
04012	M8*1,25	04096	M14*1,50 (για μπουζί)	04038	M20*2,00
04018	M10*1,00			04037	M20*2,50
04017	M10*1,25	04028	M14*2,00	04042	M22*1,50
04016	M10*1,50	04033	M16*1,50	04045	M24*1,50
04023	M12*1,25	04032	M16*2,00		



Κιτ επιδιόρθωσης σπειρωμάτων 1,5D

VCOIL



Κωδικός	Τύπος
04081	M5-M12
04081	M6-M14x1,25

Σετ επιδιόρθωσης υποδοχής μπουζί

Για κατεστραμένα σπειρώματα 14x1,25 σε κυλινδροκεφαλές από αλουμίνιο.

Περιλαμβάνει 1 οδηγό και 4 διαφορετικά σε μήκος σπειρώματα: 9,5-11-12,7-19mm



Κωδικός	Τύπος
64101	14x1,25

Κόνοι



Κωδικός	Τύπος	Κωδικός	Τύπος
CB1202	B12X2	CB1803	B18X3
CB1602	B16X2	CB2203	B22X3
CB1603	B16X3	CB2204	B22X4
CB1802	B18X2		



Φωλιές



Κωδικός	Τύπος
H0201	2X1
H0302	3X2
H0402	4X2
H0403	4X3
H0504	5X4



Κλειδιά τσοκ



Κωδικός	Τύπος
KS2A	13mm
KS3	16mm
KS4	20mm



Σφηνοβγάλτες



Κωδικός	Τύπος
BO102	1&2
BO303	3



Αντάπτορας SDS-Plus για τσοκ ½"



Κωδικός
264000002



Αντάπτορας από SDS-Plus σε SDS-MAX



Κωδικός
265150000



**Τσοκ δραπάνου πλαστικά
αυτόματα****SAN OU**

Κωδικός	Τύπος	Υποδοχή
J1513 3/8 2-13mm		3/8"-24
J1513 1/2 2-13mm		1/2"-20

**Τσοκ δραπάνου μεταλλικά
αυτόματα****SAN OU**

Με κλειδίωμα



Κωδικός	Τύπος	Υποδοχή
J991312	1,5-13mm	1/2"-20

**Τσοκ δραπάνου μεταλλικά
αυτόματα****SAN OU**

Βαρέως τύπου κωνικά



Κωδικός	Τύπος	Υποδοχή
JQ0113	B16 1-13mm	B16
JQ0116	B16 1-16mm	B16
JQ0116	B18 1-18mm	B18
JQ0120	B22 5-20mm	B22

Κώνοι

Κωδικός	Τύπος	Υποδοχή
B001002	MT1 - B12	MT1 B12
B001003	MT1 - B16	MT1 B16
B001012	MT2 - B12	MT2 B12
B001013	MT2 - B16	MT2 B16
B001014	MT2 - B18	MT2 B18
B001025	MT3 - B16	MT3 B16
B001026	MT3 - B18	MT3 B18
B001027	MT3 - B22	MT3 B22
B001038	MT4 - B16	MT4 B16
B001039	MT4 - B18	MT4 B18

**SAN OU****Φωλιές κώνων****SAN OU**

Κωδικός	Τύπος
M002030	MK2XMK1
M002032	MK3XMK2
M002034	MK4XMK2
M002035	MK4XMK3
M002039	MK5XMK4

Ανάποδες φωλιές κώνων**SAN OU**

Κωδικός	Τύπος
M003020	MK1XMK2
M003220	MK2XMK3
M003420	MK2XMK4
M003520	MK3XMK4

Κλειδιά τσοκ

Κωδικός	Τύπος	Μέγεθος
60A10MM	Για τσοκ 10mm	56mm
60A13MM	Για τσοκ 13mm	80mm
60A16MM	Για τσοκ 16mm	110mm

SAN OU**Πόντες τόννου**

Κωδικός	Τύπος
OO3059	MT2 MT2
OO3060	MT3 MT3
OO3061	MT4 MT4
OO3062	MT5 MT5

SAN OU**Τσοκ τόννου με 3 μορσέτα**

Περιλαμβάνουν σετ με εξωτερικά μορσέτα



Κωδικός	Τύπος
K11-80	Ø80
K11-100	Ø100
K11-125	Ø125
K11-160	Ø160
K11-200	Ø200
K11-250	Ø250
K11-315	Ø315

SAN OU**Τσοκ τόννου με 4 μορσέτα**

Περιλαμβάνουν σετ με εσωτερικά & εξωτερικά μορσέτα



Κωδικός	Τύπος
K12-125	Ø125
K12-160	Ø160
K12-200	Ø200
K12-250	Ø250

SAN OU

Τσοκ τόννου με 3 μορσέτα

*Κατασκευάζονται υπό την εποπτεία της Rohm



Κωδικός	Τύπος
6350Φ80	Ø80
6350Φ100	Ø100
6350Φ125	Ø125
6350Φ160	Ø160
6350Φ200	Ø200
6350Φ250	Ø250
6350Φ315	Ø315

**Πόντες τόννου**

Γερμανίας



Κωδικός	Τύπος
MK1	MK1
MK2	MK2
MK3	MK3
MK4	MK4
MK5	MK5
MT03	MT3 B'
MT04	MT4 B'
MT05	MT5 B'

**Τσοκ δραπάνου EXTRA**

Κωδικός	Τύπος
ERV10095	1-10 3/8"-24
ERV1012	1-10 1/2"-20
ERV13095	1,5-13 3/8"-24

**Τσοκ δραπάνου αυτόματα Supra-SK**

Βαρέως τύπου



Κωδικός	Τύπος
SK13127	1-13 1/2"-20

**Τσοκ δραπάνου με κλειδί**

Κωδικός	Τύπος	Κωδικός	Τύπος
P08095	0,5-8 3/8"-24	P13B16	1,5-13 B16
P10095	0,8-10 3/8"-24	P16127	3-16 1/2"-20
P10127	1-10 1/2"-20	P16158	1-16 5/8"-16
P10B12	1-10 B12	P16B16	3-16 B16
P13095	1,5-13 3/8"-24	P16B18	1-16 B18
P13127	1,5-13 1/2"-20	P20B22	5-20 B22
P13B12	1,5-13 B12		

**Τσοκ δραπάνου αυτόματα**

Κωδικός	Τύπος	Κωδικός	Τύπος
	0,5-8 3/8"-24	S16127	3-16 1/2"-20
S10095	0,5-10 3/8"-24	S165816	3-16 5/8"-16
S10127	0,5-10 1/2"-20	S16B16	3-16 B16
S10B12	0,5-10 B12	S16B18	3-16 B18
S13095	1-13 3/8"-24		3-16 B16 BT
S13127	1-13 1/2"-20		3-16 B18 BT
871046	1-13 B12		
S13B16	1-13 B16		



**Δυναμόκλειδο για καρυδάκια 1/4"**

Το 64721605 έχει υποδοχή για μανέλα

**Κωδικός** **Τύπος**

64721602 0,4-2Nm

64721605 1-5Nm

**Δυναμόκλειδο για καρυδάκια 1/4"****Κωδικός** **Τύπος**

6472195W 3-15Nm

**Δυναμόκλειδο για καρυδάκια 1/4"****Κωδικός** **Τύπος**

6472295 6-30Nm

**Δυναμόκλειδο με καρέ 1/4"****Κωδικός** **Τύπος**

6472290W 1-25Nm

**Δυναμόκλειδο με καρέ 3/8"****Κωδικός** **Τύπος**

6473295 6-30Nm

**Δυναμόκλειδο με καρέ 3/8"****Κωδικός** **Τύπος**

6473360W 10-50Nm

**Δυναμόκλειδο με καρέ 3/8"****Κωδικός** **Τύπος**

6473380 20-110Nm

**Δυναμόκλειδο με καρέ 1/2"****Κωδικός** **Τύπος**

6474535 40-210Nm

**Δυναμόκλειδο με καρέ 1/2"****Κωδικός** **Τύπος**

6474405W 20-100Nm

6474500W 40-200Nm

6474595W 60-300Nm

6474680W 80-400Nm

**Δυναμόκλειδο με καρέ 3/4"****Κωδικός** **Τύπος**

6476970W 100-550Nm

**Δυναμόκλειδο με καρέ 3/4"****Κωδικός** **Τύπος**

6476880 100-500Nm

**Δυναμόκλειδο με καρέ 1"****Κωδικός** **Τύπος**

647A8031 400-2000Nm





Δυναμόκλειδο σετ



Κωδικός **Τύπος**
64713 6-30Nm

FORCE

Δυναμόκλειδο σετ



Κωδικός **Τύπος**
64715 20-100Nm

FORCE

Δυναμόκλειδο σετ



Κωδικός **Τύπος**
64705 40-210Nm

FORCE



Recommended Maximum Bolt Loads and Torque Values (UNC Threads)												
UNC	Quality P				S				T			
in	Newtons	N.m	lbf	lbf.ft	Newtons	N.m	lbf	lbf.ft	Newtons	N.m	lbf	lbf.ft
1/4"	4379	5,43	984	4,00	8320	10,3	1870	7,60	8980	11,1	2018	8,19
5/16"	7344	11,2	1650	8,26	13954	21,3	3136	15,71	15061	23,0	3385	16,96
3/8"	10951	19,9	2461	14,68	20807	37,9	5161	27,95	22458	40,9	5048	30,17
7/16"	15065	31,9	3386	23,53	28623	60,7	6434	44,77	30894	65,5	6945	48,31
1/2"	20244	48,8	4551	36,00	38463	92,7	8646	68,37	41516	100	9333	73,76
9/16"	26075	70,4	5861	51,92	49542	134	11137	98,83	53474	144	12021	106
5/8"	32452	97,4	7295	71,84	61658	185	13861	136,45	66552	200	14961	147,5
3/4"	49781	178	11191	131,3	94584	338	21263	249,3	102091	364	22950	268,5
7/8"	67157	279	15097	205,8	127599	530	28685	391	137725	572	30961	422
1"	88221	418	19832	308,3	167620	795	37682	586	180923	858	40673	633
1 1/8"	111007	593	24955	437,4	210913	1126	47415	830	227652	1216	51178	897
1 1/4"	142135	837	31953	617,3	270091	1591	60718	1173	291527	1717	65537	1266
1 3/8"	168641	1096	37911	808,4	320417	2083	72032	1536	345847	2248	77749	1658
1 1/2"	206578	1456	46440	1074	392498	2767	88237	2041	423648	2987	95239	2203

Recommended Maximum Bolt Loads and Torque Values (UNF Threads)												
UNC	Quality P				S				T			
in	Newtons	N.m	lbf	lbf.ft	Newtons	N.m	lbf	lbf.ft	Newtons	N.m	lbf	lbf.ft
1/4"	5232	6.28	1176	4.63	9941	11,9	2234	8.78	10730	12,9	2412	9.51
5/16"	8410	12,5	1891	9.22	15979	23,8	3592	17.55	17247	25,7	3877	18.96
3/8"	12911	22,7	2903	16.74	24531	43.2	5514	31.9	26478	46.6	5952	34.4
7/16"	17416	35.9	3915	44.707	33091	68.2	7439	50.3	35717	73.6	8029	54.3
1/2"	23685	55.4	5325	40.9	45002	105	10116	77.4	48574	114	10919	84.0
9/16"	30075	79.0	6761	58.3	57143	150	12846	111	61678	162	13865	119
5/8"	38156	111	8578	81.9	72496	210	16297	155	78250	227	17591	167
3/4"	56078	195	12607	144	106549	370	23953	273	115005	399	25854	294
7/8"	76297	309	17152	228	144965	587	32589	433	156470	634	35175	468
1"	99200	459	22301	339	188480	873	42371	644	203439	942	45734	695
1 1/8"	128738	667	28941	492	244602	1267	54988	934	264015	1368	59352	1009
1 1/4"	161358	925	36275	682	306580	1757	68921	1296	330911	1896	74391	1398
1 3/8"	199331	1252	44811	923	378728	2378	85141	1754	408786	2567	91898	1893
1 1/2"	240377	1642	54039	1211	456717	3119	102673	2300	492965	3367	110822	2482

Recommended Maximum Bolt Loads and Torque Values (Metric Coarse Threads)												
	3,6		5,6		6,9		8,8		10,9		12,9	
mm	Newtons	N.m	Newtons	N.m	Newtons	N.m	Newtons	N.m	Newtons	N.m	Newtons	N.m
2	284	0,12	378	0,16	731	0,31	863	0,37	1216	0,52	1461	0,63
3	726	0,44	966	0,59	1863	1,13	2206	1,34	3109	1,88	3727	2,26
4	1255	1,00	1677	1,34	3226	2,60	3825	3,04	5374	4,31	6453	5,15
5	2059	1,96	2736	2,65	5286	5,10	6257	6,03	8806	8,48	10591	10,20
6	2903	3,43	3864	4,51	7453	8,73	8836	10,30	12405	14,71	14906	17,65
8	5315	8,24	7090	10,79	13680	21,57	16230	25,50	22751	35,30	27360	42,17
10	8473	16,7	11278	21,57	21771	42,17	25791	50,01	36284	70,61	43541	85,32
12	12356	28,4	16475	38,25	31773	73,55	37657	87,28	52956	122,60	63547	147,10
16	23340	69,6	31087	93,16	60016	178,50	71196	210,80	100027	299,10	120131	357,90
20	36481	135	48641	180	93849	384,1	111305	411,9	156415	578,6	187796	696,3
24	52563	230	70019	308,9	135331	598,2	160338	711,0	225552	1000	270662	1196
30	84043	466	112286	622,7	215745	1206	255952	1422	359902	2010	432471	2403
36	123073	814	164261	1089	316753	2099	374612	2481	527595	3491	432526	4197
42	169164	1304	225552	1746	435413	3364	515827	3991	725688	5609	870826	6727



Πολλαπλασιαστής ροπής 1:3,4



Κωδικός	Τύπος
65108	1/2" Θ - 1/2" A 176-600 NM
65109	1/2" Θ - 3/4" A 235-800 NM



Πολλαπλασιαστές ροπής 1:5



Κωδικός	Τύπος	Μέγιστη είσοδος	Μέγιστη έξοδος
65106	1/2"F 3/4"M	260Nm	1300Nm
65107	3/4"F 1"M	540Nm	2700Nm

Γωνιόμετρα ροπής σφιξίματος



Κωδικός	Τύπος
9G1802	1/2"
9G1802A	3/4"



Ηλεκτρονικό δυναμόκλειδο αντάπτορας 1/2"

- Δυνατότητα λειτουργίας με μανέλα ή κασάνια
- Ανάγνωση ροπής την στιγμή της λειτουργίας
- Αυτόματος μηδενισμός μετά τη σύσφυξη
- Υψηλής ακρίβειας ±2%
- Εύρος ροπής 30-260 ft-lb 40-350Nm
- Δεξιόστροφη - αριστερόστροφη λειτουργία
- 10 μνήμες τοποθέτησης
- Δυνατότητα επιλογής:
Nm, Ft-lb, In-lb, kg-m, kg-cm



Κωδικός	Τύπος
647G4075	76mm 290gr





Σφυγκτήρες "Π" γαλβανιζέ



Κωδικός	Διαστάσεις	Πάσο	Ανοιγμα
26-199050-0	4x13mm	M6	42mm
26-199075-0	6x16mm	M8	68mm
26-199010-0	6x16mm	M8	92mm



Μάνδαλα με ρυθμιζόμενο εύρος



Κωδικός	Τύπος
XV3-50	55mm
XV5-100	100mm



Σφυγκτήρες μαραγκών Kliklamp



Κωδικός	Τύπος
KLI12	120mm
KLI16	160mm
KLI20	200mm
KLI25	250mm



Σφυγκτήρες μαραγκών από Zama



Κωδικός	Τύπος
LM15/5	50X150mm
LM20/5	50X200mm
LM25/5	50X250mm
LM30/5	50X300mm



Σφυγκτήρες μαραγκών από χυτοσίδηρο



Κωδικός	Τύπος
TG20B8	80X200mm
TG25B8	80X250mm
TG30B8	80X300mm



Σφυγκτήρες μαραγκών από χυτοσίδηρο



Κωδικός	Τύπος
TPN20BE	100X200mm
TG20	100X200mm
TG25S10	100X250mm
TG30S10	100X300mm
TG40S10	100X400mm
TG50S10	100X500mm



Σφυγκτήρες μαραγκών από χυτοσίδηρο



Κωδικός	Τύπος
TG25	120X250mm
TG30S12	120X300mm
TG40S12	120X400mm
TG50S12	120X500mm
TG60S12	120X600mm
TG80S12	120X800mm
TG100S12	120X1000mm
TGK125	120X1250mm
TGK150	120X1500mm
TGK200	120X2000mm
TGK250	120X2500mm
TGK300	120X3000mm



Σφυγκτήρες μαραγκών από χυτοσίδηρο



Κωδικός	Τύπος
TGRC40	175X400mm
TGRC50S17	175X500mm
TGRC60S17	175X600mm
TGRC80S17	175X800mm
TGRC100S17	175X1000mm



Σφυγκτήρες μαραγκών από χυτοσίδηρο



Κωδικός	Τύπος
TGN40T20	200X400mm
TGN60T20	200X600mm
TGN80T20	200X800mm
TGN100T20	200X1000mm

Σφυγκτήρες μαραγκών από χυτοσίδηρο



Κωδικός	Τύπος
TGN40T25	250X400mm
TGN60T25	250X600mm
TGN80T25	250X800mm
TGN100T25	250X1000mm

Σφυγκτήρες - τεντωτήρες



Κωδικός	Τύπος
EZL15-8	150X80mm
EZ15-6	150X60mm
EZ30-6	300X60mm
EZS15-8	150X80mm
EZS30-8	300X80mm
EZS45-8	450X80mm
EZS60-8	600X80mm

Σφυγκτήρες μαραγκού μεγάλης αντοχής με προφίλ τύπου 'H'

20% μεγαλύτερη δύναμη. Σύσφιξη μέχρι 6000N



Κωδικός	Τύπος
GZ16K	160mm
GZ20K	200mm
GZ25K	250mm
GZ30K	300mm
GZ40K	400mm
GZ50K	500mm
GZ60K	600mm
GZ80K	800mm
GZ100K	1000mm

Σφυγκτήρες μαραγκού για δύσκολα σημεία

Σύσφιξη μέχρι 2000N.
Γρήγορη αποδέσμευση



Κωδικός	Τύπος
GK15	150mm
GK30	300mm
GK45	450mm
GK60	600mm

Σφυγκτήρας για σωλήνα 3/4"



Κωδικός
BPC-H34



Μόρσες δραπάνου

Ελαφρού τύπου



Κωδικός	Τύπος
BSH1 7193	60mm
BSH2 7194	80mm
BSH3 7196	100mm



Μόρσες δραπάνου

Βαρέως τύπου



Κωδικός	Τύπος
BSH4 7197	80mm
BSH5 7201	100mm
BSH6 7202	120mm
BSH7 7207	140mm



Διπλός σφιγκτήρας μόρσα για σύνδεση ντουλαπιών



Κωδικός	Τύπος
FRZ12	80-120mm



Σαπόρτ



Κωδικός	Τύπος
6540503	3"
6540504	4"
6540505	5"
6540506	6"



Μόρσες ελαφρού τύπου



Κωδικός	Τύπος
MEDM5-80	75mm
MEDM5-100	100mm



Μόρσες περιστρεφόμενες



Κωδικός	Τύπος
6540204A	100mm
6540205A	125mm
6540206A	150mm
6540208A	200mm



Αμόνια χυτά



Κωδικός	Τύπος
MEDM215-10	10kg
MEDM215-20	20kg
MEDM215-25	25kg





Μόρσες ατσάλινες

Fortisimo



Κωδικός	Τύπος	Κωδικός	Τύπος
60210020100	100mm	60210020150	150mm
60210020115	115mm	60210020175	175mm
60210020125	125mm	60210020200	200mm
60210020135	135mm		

KANCA
DESIGN • FUNCTION • SAFETY

Μόρσες υδραυλικών ατσάλινες

Fortisimo plumber



Κωδικός	Τύπος
6026020502125	125mm
6026020502135	135mm
6026020502150	150mm

KANCA
DESIGN • FUNCTION • SAFETY

Μόρσες πάγκου περιστρεφόμενες ατσάλινες

Finemechanic's Vice



Κωδικός	Τύπος
60210300050	50mm
60210300075	75mm

KANCA
DESIGN • FUNCTION • SAFETY



Λειαντικά δραπάνου με σφυριδόπανο

SFL

Κωδικός	Τύπος	Grit	Κωδικός	Τύπος	Grit
A2200010103080	10X10mm	80	A2200050206080	50X20mm	80
	15X10mm	60	A2200050206120	50X20mm	120
A2200015153080	15X15mm	80	A2200050306060	50X30mm	60
	20X15mm	60	A2200050306080	50X30mm	80
A2200025156080	25X15mm	80	A2200050306120	50X30mm	120
A2200025206080	25X20mm	80	A2200060206060	60X20mm	60
A22000252006120	25X20mm	120	A2200060206080	60X20mm	80
A2200025256080	25X25mm	80	A2200060206120	60X20mm	120
A2200030156060	30X15mm	60	A2200060306060	60X30mm	60
A2200030156080	30X15mm	80	A2200060306080	60X30mm	80
A2200030156120	30X15mm	120	A2200060306120	60X30mm	120
A2200030206060	30X20mm	60	A2200060406060	60X40mm	60
A2200030206080	30X20mm	80	A2200060406080	60X40mm	80
A2200030206120	30X20mm	120	A2200060406120	60X40mm	120
A2200040206060	40X20mm	60	A2200080306060	80X30mm	60
A2200040206080	40X20mm	80	A2200080306080	80X30mm	80
A2200040206120	40X20mm	120	A2200080306120	80X30mm	120
A2200040306060	40X30mm	60	A2200080406060	80X40mm	60
A2200040306080	40X30mm	80	A2200080406080	80X40mm	80
	40X30mm	120	A2200080406150	80X40mm	150
A2200050206060	50X20mm	60			



Λειαντικά δραπάνου με φλιν

SFV

Κωδικός	Τύπος
A2203050206106	50X20mm
A2203050306104	50X30mm
A2203050406104	50X40mm
A2203060406104	60X40mm
A2203080406104	80X40mm
A2203080506104	80X50mm



Λειαντικά δραπάνου με φλιν και σφυριδόπανο

SFM

Κωδικός	Τύπος
A2204050306106	50X30mm
A2204050406104	50X40mm
A2204060406104	60X40mm
A2204080406104	80X40mm
	80X50mm



Λειαντήρες κυλίνδρων - τρίφτες βαλβίδων

Κωδικός	Τύπος
9G0902	Ø19-63,5mm
9G0901	Ø50-178mm



Ανταλλακτικές πέτρες

Για τους λειαντήρες κυλίνδρων - τρίφτες βαλβίδων



Κωδικός	Τύπος
9G0902S	5X28,5mm
9G0901S	10X100mm

Σμυριδόπετρες δραπάνου κυλινδρικές **NEO**

Κωδικός	Τύπος	Κωδικός	Τύπος	Κωδικός	Τύπος
MA.007	Ø10x10x3mm	MA.022	Ø15x20x6mm	MA.032	Ø25x20x6mm
MA.016	Ø10x20x6mm	MA.024	Ø15x30x6mm	MA.034	Ø25x30x6mm
MA.017	Ø10x30x6mm	MA.025	Ø15x40x6mm	MA.035	Ø25x40x6mm
MA.018	Ø12x12x6mm	MA.027	Ø20x20x6mm	MA.036	Ø30x20x6mm
MA.019	Ø12x20x6mm	MA.029	Ø20x30x6mm	MA.038	Ø30x30x6mm
MA.020	Ø12x30x6mm	MA.030	Ø20x40x6mm	MA.039	Ø30x40x6mm

Σμυριδόπετρες δραπάνου ημικωνικές **NEO**

Κωδικός	Τύπος
MB.002	Ø10x15x6mm
MB.003	Ø10x20x6mm
MB.004	Ø15x25x6mm
MB.005	Ø20x30x6mm
MB.006	Ø25x30x6mm
MB.007	Ø30x40x6mm

Σμυριδόπετρες δραπάνου σφαιρικές **NEO**

Κωδικός	Τύπος
ME.005	Ø10x6mm
ME.006	Ø15x6mm
ME.007	Ø20x6mm
ME.008	Ø25x6mm
ME.009	Ø30x6mm

Σμυριδόπετρες δραπάνου κώνικες **NEO**

Κωδικός	Τύπος
MF.003	Ø10x15x6mm
MF.004	Ø20x25x6mm
MF.005	Ø25x30x6mm
MF.006	Ø30x30x6mm

Σμυριδόπετρες δραπάνου φρεζάτες **NEO**

Κωδικός	Τύπος
MH.001	Ø20x6x6mm
MH.002	Ø30x10x6mm
MH.003	Ø40x10x6mm
MH.004	Ø50x10x6mm

Σετ 5 σμυριδόπετρες **NEO**

Κωδικός	Τύπος
399.00	Άξονας Ø6mm

Άξονάκι δραπάνου για δίσκους **NEO**

Κωδικός	Τύπος
336.00	12,8x8mm

Κετσέδες στίλβωσης με άξονα 6mm **NEO**

Κωδικός	Τύπος
339.46	Ø80mm





Συρματόβουρτσες πινέλο



Κωδικός	Τύπος
BA1200E	Ø12mm
BA1500E	Ø15mm
BA1900E	Ø19mm
BC2600E	Ø26mm
BBC9078	Ø26mm blister



Συρματόβουρτσες πινέλο

πλαστικοποιημένες



Κωδικός	Τύπος
451.160	10mm
452.160	16mm
453.160	22mm
456.160	28mm



Συρματόβουρτσες ίσιες με άξονα



Κωδικός	Τύπος
BDER9348	Ø50mm
BDER9448	Ø60mm
BDER9548	Ø75mm
BDER9648	Ø100mm



Συρματόβουρτσες ίσιες με άξονα INOX



Κωδικός	Τύπος
415.362	Ø50mm-10
416.362	Ø60mm-10
416.363	Ø60mm-14
417.362	Ø70mm-12
417.363	Ø70mm-16
418.362	Ø80mm-12
418.363	Ø80mm-18
41Z.362	Ø100mm-14
41Z.363	Ø100mm-19



Συρματόβουρτσες ίσιες με άξονα πλαστικοποιημένες



Κωδικός	Τύπος
415.160	Ø50mm
416.160	Ø60mm
417.160	Ø76mm



Βούρτσες πλαστικές πινέλο με άξονα



Κωδικός	Τύπος	Grit
CNA9422	Ø25mm	80
CNA9522	Ø25mm	150



Βούρτσες πλαστικές ίσιες με άξονα INOX



Κωδικός	Τύπος	Grit
CNA9475	Ø75mm	80
CNA9575	Ø75mm	150



Συρματόβουρτσες καμπίνα με άξονα INOX

Κωδικός	Τύπος
434.365	Πλαστικό 40X20mm καπάκι
435.365	Πλαστικό 50X25mm καπάκι
435.362	Μεταλλικό 50X10mm καπάκι
437.362	Μεταλλικό 70X15mm καπάκι



Συρματόβουρτσες ίσιες με άξονα INOX



Κωδικός	Τύπος
CDE97510Z	Ø75mm - 10mm
CDE97500Z	Ø75mm - 15mm



Συρματόβουρτσες καμπάνα με άξονα



Κωδικός	Τύπος
BTE9168	Ø50mm
BTE9268	Ø75mm



Συρματόβουρτσες δίδυμου τροχού



Κωδικός	Τύπος
CT1205E99	Ø125mm
CT1507E99	Ø150mm
CT1705E99	Ø175mm
CT1707E99	Ø175mm-27
CT2006E99	Ø200mm
CT2506E99	Ø250mm



Συρματόβουρτσα τροχού ανοικτή καμπάνα



Κωδικός	Τύπος
HSD0100EM14	Ø100mm



Συρματόβουρτσες τροχού ανοικτές καμπάνα σγουρές



Κωδικός	Τύπος
HSK0100EM14	Ø100mm
HSK0100KM14	Ø100mm
HSK0120KM14	Ø120mm



Συρματόβουρτσες τροχού καμπάνα



Κωδικός	Τύπος
TO0600EM14	Ø60mm
TO0800EM14	Ø80mm
TO1000EM14	Ø100mm

Συρματόβουρτσες τροχού καμπάνα
Με κοτσίδες

Κωδικός	Τύπος
TT0601LM14	Ø60mm
TT0601JM14	Ø60mm
TT0801LM14	Ø80mm
TT1001LM14	Ø100mm



Συρματόβουρτσες τροχού ίσιες με κοτσίδες



Κωδικός	Τύπος
CAM1501KM14	Ø150mm
CAM1701KM14	Ø175mm



Συρματόβουρτσες τροχού ίσιες σγουρές



Κωδικός	Τύπος
HSR0115KM1	Ø115mm



Συρματόβουρτσες τροχού καμπάνα INOX



Κωδικός	Τύπος
421.367	Ø60mm
423.367	Ø75mm
426.367	Ø100mm

LESSMANN
THE GIBBONS BRUSH COMPANY

Συρματόβουρτσες τροχού ίσιες INOX



Κωδικός	Τύπος
422.367	Ø100mm

LESSMANN
THE GIBBONS BRUSH COMPANY

Συρματόβουρτσες τροχού ίσιες INOX

Με κοτσίδες



Κωδικός	Τύπος
471.757	Ø100mm

LESSMANN
THE GIBBONS BRUSH COMPANY

Συρματόβουρτσες τροχού καμπάνα INOX

Με κοτσίδες



Κωδικός	Τύπος
482.717	Ø65X18mm
484.217	Ø80X14mm
480.717	Ø80X18mm
486.217	Ø100X14mm

LESSMANN
THE GIBBONS BRUSH COMPANY

Συρματόβουρτσες καμπάνα ίσιες



Κωδικός	Τύπος
98101	65mm
98102	75mm

PEGATEC

Συρματόβουρτσες καμπάνα ζγουρές



Κωδικός	Τύπος
98301	65mm
98302	75mm

PEGATEC

Συρματόβουρτσες δίδυμου τροχού



Κωδικός	Τύπος
98403	125X16mm
98404	150X18mm
98405	175X20mm
98406	200X20mm

PEGATEC

Συρματόβουρτσες ανοικτή καμπάνα



Κωδικός	Τύπος
98802	100X21mm ίσια
98902	100X21mm ζγουρή

PEGATEC

Συρματόβουρτσα **NEO**

Κωδικός
497.00

Συρματόβουρτσα inox **NEO**

Κωδικός
496.99



Συρματόβουρτσα 5 σειρών



Κωδικός Τύπος
30-472005-0 Σκληρή τρίχα



Συρματόβουρτσες ορειχάλκινες 3 σειρών



Κωδικός Τύπος
30-472003-0 Σκληρή τρίχα
30-472503-0 Μαλακή τρίχα



Συρματόβουρτσα ορειχάλκινη



Κωδικός
182.331



Συρματόβουρτσα πόλων μπαταρίας



Κωδικός
MPB1000



**Τουμπόβουρτσες νάιλον**

Κωδικός	Τύπος	Κωδικός	Τύπος
501.801	Ø6mm	500.816	Ø16mm
500.808	Ø8mm	500.818	Ø18mm
500.810	Ø10mm	500.819	Ø19mm
500.812	Ø12mm	500.820	Ø20mm
500.813	Ø13mm	500.822	Ø22mm
500.814	Ø14mm	500.825	Ø25mm
500.815	Ø15mm		

LESSMANN
THE HELLAS TOOL COMPANY

Τουμπόβουρτσες με σκληρή τρίχα

Κωδικός	Τύπος	Κωδικός	Τύπος
L10	Ø10mm	L30	Ø30mm
L12	Ø12mm	L35	Ø35mm
L13	Ø13mm	L40	Ø40mm
L14	Ø14mm	L45	Ø45mm
L15	Ø15mm	L50	Ø50mm
L16	Ø16mm	L55	Ø55mm
L18	Ø18mm	L60	Ø60mm
L20	Ø20mm	L65	Ø65mm
L25	Ø25mm	L70	Ø70mm

JAZ

Τουμπόβουρτσες με λεπτή τρίχα

Κωδικός	Τύπος	Κωδικός	Τύπος
L1F10	Ø10mm	L1F30	Ø30mm
L1F12	Ø12mm	L1F35	Ø35mm
L1F14	Ø14mm	L1F40	Ø40mm
L1F15	Ø15mm	L1F45	Ø45mm
L1F16	Ø16mm	L1F50	Ø50mm
L1F18	Ø18mm	L1F55	Ø55mm
L1F20	Ø20mm	L1F60	Ø60mm
L1F25	Ø25mm	L1F70	Ø70mm

JAZ

Λαβές τουμπόβουρτσας

Κωδικός	Τύπος	Κωδικός	Τύπος
566.603	4mm	567.601	½"
566.601	6mm	567.603	¾"

LESSMANN
THE HELLAS TOOL COMPANY

**Σετ λίμες**

Στρόγγυλη, τρίγωνη,
τετράγωνη,
ημιστρόγγυλη,
πλατιά, μαχαιρωτή

**Κωδικός**

26-270006-9

**Μίνι λίμες σετ**

Πλατιά, τετράγωνη,
τρίγωνη, ημιστρόγγυλη,
στρόγγυλη

**Κωδικός** **Τύπος**

5335-005 5 τεμαχίων

TopMan**Μανέλα λείανσης σμυριδοτροχού**

■ *Made in Japan*

**Κωδικός** **Τύπος**

TS-24S

**Ανταλλακτικά μανέλας λείανσης σμυριδοτροχού**

■ *Made in Japan*

**Κωδικός** **Τύπος**

TS-24SB

**Σπειρολίμα σε χλιοστά****Κωδικός**

66901

**Σπειρολίμα σε ίντσες****Κωδικός**

66902

**Λαβές λίμας****Κωδικός**

26-317008-0

26-317010-0

26-317012-0

Γυαλιά ηλεκτροκόλλησης 90X110**Κωδικός** **Τύπος**

30-461009-0 DIN9

30-461010-0 DIN10

30-461011-0 DIN11

30-461013-0 DIN13

**Γυαλιά ηλεκτροκόλλησης 75x98**

Σκούρα

**Κωδικός** **Τύπος**

9TMVI009 DIN9

9TMVI010 DIN10

9TMVI011 DIN11

**Γυαλιά ηλεκτροκόλλησης 75x98**

Διαφανή

**Κωδικός**

9TMVT000





Βύσματα καλωδίων ηλεκτροκόλλησης

Αρσενικά



Κωδικός	60%	35%	Τύπος
9TCC-10-25-P	200A	250A	25mm ²
9TCC-35-50-P	300A	400A	50mm ²



Βύσματα καλωδίων ηλεκτροκόλλησης

Θηλυκά για σασί



Κωδικός	60%	35%	Τύπος
9TCC-10-25-PS	200A	250A	25mm ²
9TCC-35-50-PS	300A	400A	50mm ²



Τσιμπίδα γείωσης ηλεκτροκόλλησης

400A



Κωδικός
30-437040-0



Τσιμπίδα γείωσης ηλεκτροκόλλησης

400A



Κωδικός	60%	35%	Τύπος
9TEC200NT	200A	250A	35mm ²
9TEC350NT	300A	400A	50mm ²



Τσιμπίδες ηλεκτροκόλλησης



Κωδικός	60%	35%	Τύπος	Τύπος
9TEH200FCL	150A	200A	25mm ²	≤3,2mm
9TEH300FCL	200A	300A	35mm ²	≤4mm



Μάσκα ηλεκτροσυγκόλλησης



Κωδικός
9TMM10



Μάσκα ηλεκτροσυγκόλλησης



Κωδικός
9TMM40





Ηλεκτρόδια κοινά

FINCORD-M E6013



Κωδικός	Τύπος	Συσκευασία
502201	2,00mm	3,5kg
502202	2,50mm	4kg
502203	3,25mm	4kg

*το κιλό



Ηλεκτρόδια ουρανού

REX E6012



Κωδικός	Τύπος	Συσκευασία
502228	2,50mm	4kg
502229	3,25mm	4kg

*το κιλό



Ηλεκτρόδια βασικά

SUPERCITO E7018



Κωδικός	Τύπος	Συσκευασία
502249	2,50mm	3kg
502250	3,25mm	4,5kg

*το κιλό



Ηλεκτρόδια σκληρά για γεμίσματα

CITODUR-600A

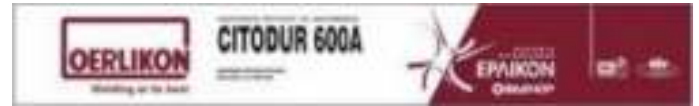

Κωδικός	Τύπος	Συσκευασία
502313	3,25mm	5,5kg
502314	4,00mm	5,5kg

*το κιλό



Ηλεκτρόδια για ανοξείδωτα

BELINOX



Κωδικός	Τύπος	Συσκευασία
502370	E308 L-162,50mm	INOX308 3kg
502371	E308 L-163,25mm	INOX308 3kg
502374	E316 L-162,00mm	INOX316 3kg
502375	E316 L-162,50mm	INOX316 3kg
502376	E316 L-163,25mm	INOX316 3kg

*το κιλό



Ηλεκτρόδια για χυτοσίδηρο

CITOFONTE MONEL E6013



Κωδικός	Τύπος	Συσκευασία
502378	2,50mm	Σακουλάκι 1kg
502379	3,00mm	Σακουλάκι 1kg

*το κιλό



Σύρμα ηλεκτροκόλλησης

PLW



Κωδικός	Τύπος	Συσκευασία
508110	0,8mm	15kg
510840	1,0mm	15kg

*το κιλό



Λουκέτα ορειγάλκινα



Κωδικός	Τύπος
Y1100025080X	25mm
Y1100030080X	30mm
Y1100040080X	40mm
Y1100050080X	50mm
Y1100060080X	60mm
Y1100070080X	70mm

Λουκέτα ορειγάλκινα μακρύλαιμα



Κωδικός	Τύπος
Y1130025080X	25mm
Y1130030080X	30mm
Y1130040080X	40mm
Y1130050080X	50mm
Y1130060080X	60mm

Λουκέτα INOX



Κωδικός	Τύπος
1140030	30mm
1140040	40mm
1140050	50mm

Λουκέτα μακρύλαιμα INOX



Κωδικός	Τύπος
1150030	30mm
1150040	40mm
1150050	50mm

Λουκέτα τάκου χαλύβδινα



Κωδικός	Τύπος
1640185	85mm

Λουκέτα τάκου ορειγάλκινα



Κωδικός	Τύπος
FFL8370000	75mm
FFL8390000	93mm

Αλυσίδα ασφαλείας μηχανής



Κωδικός	Τύπος
FFCHA81200	8x1200mm
FFCHA81500	8x1500mm

Κλειδαριά γλώσσα σκέτη**Κωδικός Τύπος**

FFA1720200 20mm
 FFA1725200 25mm
 FFA1730200 30mm
 FFA1735200 35mm
 FFI1540110 40mm

**Κλειδαριά γλώσσα με κύλινδρο 3 κλειδιά****Κωδικός Τύπος**

FFLOC20C 20mm
 FFLOC30C 30mm
 FFLOC45C 45mm

**Κλειδαριά μπίλια με κύλινδρο 3 κλειδιά****Κωδικός Τύπος**

FFLOCBAL20C 20mm
 FFLOCBAL25C 25mm
 FFLOCBAL30C 30mm
 FFLOCBAL35C 35mm
 FFLOCBAL45C 45mm

**Κλειδαριά κουτιαστή****Κωδικός Τύπος**

FFP2450100-R Δεξιά
 FFP2450100-L Αριστερή

**Κύλινδροι ασφαλείας****Κωδικός Τύπος**

FFSY61 N61 28/32
 FFSY70 N70 34/34
 FFSY71 N71 30/40
 FFSY81 N70 30/50
 FFSY82 N70 40/40

**Κύλινδροι ασφαλείας****Κωδικός Τύπος**

FFSY326378 30,5/30,5
 FFSY327278 30,5/40,5
 FFSY328278 30,5/50,5
 FFSY328378 40,5/40,5
 FFSY350378 40,5/60,5

**Κύλινδροι****Κωδικός Τύπος**

FFC1063180 30,5-30,5mm
 FFC1072180 30,5-40,5mm
 FFC1082180 30,5-50,5mm
 FFC1083180 40,5-40,5mm
 FFC1003180 40,5-60,5mm

**Κυπρί πόρτας****Κωδικός Τύπος**

F16219P/1F 250mm





**Σφυριά πένας**

Κωδικός	Τύπος
10361	300gr
10381	500gr
10401	800gr

Kapriol**Σφυριά ξυλουργού Evolution**

Κωδικός	Τύπος
10100	Evo 9.0 300gr
10102	Evolution 300gr

Kapriol**Βαριοπούλες με ξύλινη λαβή**

Κωδικός	Τύπος
10130	800gr
10140	1000gr
10150	1200gr
10160	1500gr
10170	2000gr

Kapriol**Βαριοπούλες με λαβή fiber**

Κωδικός	Τύπος
10133	800gr
10143	1000gr
10153	1200gr
10163	1500gr

Kapriol**Ματσακόνι**

Κωδικός
495000

**Ματσόλες**

Κωδικός	Τύπος
23-137027-0	27mm
23-137032-0	32mm
23-137035-0	35mm
23-137040-0	40mm
23-137050-0	50mm
23-137060-0	60mm
23-138550-0	Ανταλλακτικά 50mm
23-138560-0	Ανταλλακτικά 60mm

**Ματσόλες**

Κωδικός	Τύπος
10180	300gr
10181	500gr

Kapriol**Ματσόλες**

Σκληρότητα: 80±5 Shore A



Κωδικός	Τύπος
B5GK50	Μπλε Ø48 - 500gr
B5GK51	Λευκή Ø48 - 500gr
B5GK100	Μπλε Ø59 - 1000gr
B5GK101	Λευκή Ø59 - 1000gr

Ιταλίας

Σκύλες εξάγωνες 18mm



Κωδικός	Τύπος
20412	60cm
20414	80cm
20415	1m

Kapriol

Σκύλες από ανθρακούχο ατσάλι 30X17mm
Οβάλ προφίλ

Κωδικός	Τύπος
20396	60cm
20397	80cm
20398	1m

Kapriol

Κοπίδια



Κωδικός	Τύπος	Πάχος
20020	200mm	10mm
20030	250mm	10mm
20050	250mm	16mm

Kapriol

Κοπίδια



Κωδικός	Τύπος
3101000/1	100mm
3101500/1	150mm
3102000/1	200mm
3102500/1	250mm
3103000/1	300mm

RENNSTFIG

Κοπίδια φαρδιά



Κωδικός	Τύπος
3850501	250X50mm
3850601	250X60mm
3850701	250X70mm

RENNSTFIG

Κοπίδια λεπτά



Κωδικός	Τύπος
3802400/1	240mm

RENNSTFIG

Κοπίδια ηλεκτρολόγων



Κωδικός	Τύπος
3602021	200mm
3602521	250mm

RENNSTFIG

Βελόνια



Κωδικός	Τύπος
3302000/1*	200mm
3302500/1*	250mm
3303000/1*	300mm

RENNSTFIG

Βελόνι



Κωδικός	Τύπος
20150	250mm

Kapriol

**Μακαράδες**

Κωδικός	Τύπος
25150	145mm
25170	180mm

Karriol**Γρύλος RAPID με κοχλία NEO**

Για σφιγκτήρες τοιχίων (πεταλούδες)



Κωδικός	Τύπος
25291	

Karriol**Κουβάς πλαστικός**

Κωδικός	Τύπος
25221	Ø36cm

Karriol**Κουβάς λάσπης**

Κωδικός	Τύπος
25216	25l

Karriol**Κουβάς λάσπης**

Κωδικός	Τύπος
25234	40l

Karriol

Πιστόλι σιλικόνης



Κωδικός
25244

Kapriol

Πιστόλι σιλικόνης βαρέως τύπου



Κωδικός
25246

Kapriol

Πιστόλι αφρού πολουρεθάνης



Κωδικός
25261

Kapriol

Τσουβαλοδέτες



Κωδικός
22-253031-0



Σκαπανοτσέκουρα



Κωδικός Τύπος
10790 400gr

Kapriol

Κασμαδάκι



Κωδικός Τύπος
10820 400gr

Kapriol

Κασμαδάκια κτίστη



Κωδικός Τύπος
10710 500gr (ξύλινη λαβή)
10711 500gr (fiber λαβή)

Kapriol

Τσεκουράκια



Κωδικός Τύπος
11031 600gr

Kapriol

**Αλουμινένιο πεντάλ ανύψωσης****Κωδικός**
25637**Kapriol****Χειρολαβή μεταφοράς γυψοσανίδων****Κωδικός**
25639**Kapriol****Πριόνι γυψοσανίδας****Κωδικός**
50133**Kapriol****Ράσπα χούφτας****Κωδικός Τύπος**
25662 40X140**Kapriol****Ράσπα γυψοσανίδας****Κωδικός Τύπος**
25659 40X250**Kapriol****Ανταλλακτική λεπίδα ράσπας****Κωδικός Τύπος**
25661 40X250**Kapriol****Πρέσα γυψοσανίδων****Κωδικός**
25655**Kapriol****Πρέσα γυψοσανίδων****Κωδικός**
25656**Kapriol**



Τηλεσκοπικός βραχίονας κάθετης στήριξης γυψοσανίδας

Κλίση $\leq 45^\circ$. Βάρος έως 350 κιλά, ανάλογα το μήκος τοποθέτησης.

*Σε κλίση 45° , μέγιστο βάρος 40kg.



Κωδικός	Τύπος	Βάρος
STE250	1,45-2,50m	200-350kg 73,40
STE300	1,70-3,00m	130-350kg 84,00
STE370	2,07-3,70m	75-350kg 89,50



Σπάτουλα κόλλας πλακιδίων με δόντια



Κωδικός	Δόντια
23020	8X8
23022	10X10

Kapriol

Σπάτουλα πλακιδίων με δόντια



Κωδικός	Δόντια
23192	1,63X3

Kapriol

Σπάτουλα πλακιδίων με δόντια



Κωδικός	Δόντια
23188	5X5
23187	10X10

Kapriol

Σπάτουλες φαρδιές με ξύλινη λαβή



Κωδικός	Τύπος
23221	10cm
23218	12cm
23222	14cm
23219	16cm
23223	18cm
23220	20cm

Kapriol

Στοκαδόροι με ξύλινη λαβή



Κωδικός	Τύπος
23131	30mm
23141	40mm
23151	50mm
23161	60mm
23171	70mm
23181	80mm

Kapriol

Στοκαδόροι INOX



Κωδικός	Τύπος
23143	40mm
23163	60mm
23183	80mm
23203	100mm

Kapriol

Λοχείο Mosca



Κωδικός
23490

Kapriol

**Ξύστρα****Κωδικός**

23180

Kapriol**Ξύστρα πολυχρηστική 6 σε 1****Κωδικός**

23147

Kapriol**Ξύστρες κονταριού**

Λάμα από ανθρακούχο ατσάλι

**Κωδικός** **Τύπος**

23318 100mm

23322 150mm

Kapriol**Ξύστρα με ξυράφια 200mm**

SCL-200BC

Περιέχει 5 λάμες

**Κωδικός**

525538

KDS

**Μαγνητικό αλφάδι τσέπης 75mm**

Υψηλής ευκρίνειας



Κωδικός	Τύπος
GO!	Χωρίς κλιπ ζώνης
GO! CLIP	Με κλιπ ζώνης

**Ψηφιακό αλφάδι με σύνδεση Bluetooth ^{NEO}**

Κωδικός	Τύπος
GO! SMART 80x55x27mm	

**Μαγνητικό αλφάδι τσέπης πλαστικό**

3 μάτια



Κωδικός	Τύπος
PTM-520	20cm

**Αλφάδια αλουμινίου**

3 μάτια



Κωδικός	Τύπος
I5-30	30cm
I5-40	40cm
I5-50	50cm
I5-60	60cm
I5-80	80cm
I5-100	100cm
I5-120	120cm

**Αλφάδια αλουμινίου βαρέως τύπου**

2 μάτια



Κωδικός	Τύπος
AZ-40	40cm
AZ-50	50cm
AZ-60	60cm
AZ-80	80cm
AZ-100	100cm
AZ-120	120cm
AZ-150	150cm
AZ-180	180cm
AZ-200	200cm

**Αλφάδια αλουμινίου μαγνητικά βαρέως τύπου**

2 μάτια



Κωδικός	Τύπος
AZM-30	30cm
AZM-40	40cm
AZM-50	50cm
AZM-60	60cm
AZM-80	80cm
AZM-100	100cm
AZM-120	120cm
AZM-150	150cm
AZM-180	180cm
AZM-200	200cm

**Αλφάδια αλουμινίου μαγνητικά**

Ιδανικό για εγκαταστάτες.
Τοποθετείται και σε σωλήνες.
Μαγνήτες νεοδυμίου.



Κωδικός	Τύπος
MRMI 40	40cm
MRMI 100	100cm

**Αλφάδι ηλεκτρολόγων ^{NEO}**

Στιβαρό προφίλ αλουμινίου με 4 μετακινούμενα μέρη σημαδέματος.



Κωδικός	Τύπος
ELECTRIC	40cm

**Αλφάδι νήματος**

Κωδικός	Τύπος
UZ8	80mm



Αλφαδοπήχες αλουμινίου



Κωδικός	Τύπος
SLN 1 200	2m 1 μάτι προφίλ 80X18
SLN 1 250	2,5m 1 μάτι προφίλ 80X18
SL 2 200	2m 2 μάτια προφίλ 100X18
SL 2 250	2,5m 2 μάτια προφίλ 100X18

Αλφάδι ακρυλικό **NEO**

Κωδικός	Τύπος
R100	18cm



Αλφάδι μάτι 360°



Κωδικός	Τύπος
DF 30	Ø30mm



Αλφάδι σταυρός με 2 μάτια



Κωδικός	Τύπος
K5	60X45mm



Ξύλινα μέτρα



Κωδικός	Τύπος
HF 2/10	2m (Το 0 ξεκινάει από την επάνω πλευρά)
Δίχρωμο	
CH 2/10	2m (Το 0 ξεκινάει από την κάτω πλευρά)
Μπεζ	🇸🇪 Made in Sweden



Μολύβια



Κωδικός	Τύπος
SB 24	Σήμανσης φωσφορούχο
STB 24	Οικοδόμου
ZB 24	Ξυλουργού
RBB 17	Δίχρωμο



Μηχανικό μολύβι μαρκαρίσματος

Κατάλληλο για τρύπες



Κωδικός	Τύπος
TLM2	150mm
SG TLM2 HB	6 μύτες μαύρες
SC TLM2	6 μύτες έγχρωμες

Μαρκαδόρος σημαδέματος για τρύπες **NEO**

Κωδικός	Τύπος
DHM	145mm

Τρίγωνο σχεδιαστών με πατούρα **NEO**

Κωδικός	Τύπος
RS18	100x50x15cm



**Γρασαδοράκια ίσια****Τύπος**

6X1
6X1 30mm
8X1
8X1,25
10X1
10X1,5
1/8" GAS
1/4" GAS
1/4" (28)

**Γρασαδοράκια 45°****Τύπος**

6X1
8X1
8X1,25
10X1
10X1,5
1/8" GAS
1/4" GAS
1/4"
5/16"

**Γρασαδοράκια 90°****Τύπος**

6X1
8X1
8X1,25
10X1
10X1,5
1/8" GAS
1/4" GAS
1/4"
5/16"

**Γρασαδοράκια ίσια INOX****Τύπος**

6X1
8X1
10X1
1/8" GAS
1/4" GAS
1/4"
5/16"

**Γρασαδοράκια 45° INOX****Τύπος**

6X1
8X1
10X1
1/8" GAS
1/4" GAS
1/4"

**Γρασαδοράκια 90° INOX****Τύπος**

6X1
8X1
10X1
1/8" GAS
1/4" GAS
1/4"

**Γρασαδοράκια συρταρωτά****Τύπος**

1/4" GAS
3/8" GAS

**Γρασαδοράκια συρταρωτά****Κωδικός Πάσο Τύπος**

1001701	1/8"	5/8"
1001700	1/4"	5/8"
10002202	1/4"	7/8"
10002201	3/8"	7/8"

**Γρασαδοράκια τσοκ συρταρωτά****Τύπος**

5/8"
7/8"

**Εύκαμπτες προεκτάσεις γρασαδόρου 1/8"****Τύπος**

280mm
480mm

Χειροκίνητη τρόμπα λαδιού

Για λάδια έως SAE 50
Κατάλληλη για βαρέλια
60/200/220 l

**Κωδικός Τύπος**

13020 2" 12l/min



Γρασαδόρος χειρός - αέρος σεντ

Κωδικός Τύπος
88701L 500cc

FORCE

Γρασαδόρος αέρος

Κωδικός Τύπος
18071 1,84kg M10x1

PRESSOL

Γρασαδόρος χειρός G 1/8"

Κωδικός Τύπος
12632 125 500cm³

PRESSOL

Γρασαδόρος χειρός μίνι G 1/8"

Λειτουργεί με ένα χέρι



Κωδικός Τύπος
12276 125cm³

PRESSOL

Γρασαδόρος πατητός

Κωδικός Τύπος
12332 150ml

PRESSOL

Τσοκ γρασαδόρου

Κωδικός	Τύπος
12731	SW 13mm Ø15mm G1/8"
12726	G1/8" female SW13mm - Ø13mm λεπτό
12649	G1/8" female Ø15mm
125	Αυτόματο 690bar

PRESSOL

Γρασαδόρος συνεργείου

Κωδικός Τύπος
17791 16kg

PRESSOL

Λαδικά χειρός

1ml ανά πάτημα

Κωδικός	Τύπος
05121	125 ml
05122	175 ml
05133	250 ml
05134	350 ml
05135	500 ml
05226	750 ml



PRESSOL

Λάδι - Γράσσο - Γραφίτης

Γενικής χρήσης

Κωδικός	Τύπος
10097	Λάδι 100ml
10564	Γράσσο 80γρ
10589	Γραφίτης 50gr



PRESSOL



Σφήνες ίσιες



Τύπος	Τύπος	Τύπος	Τύπος	Τύπος
4X4X16mm	6X6X80mm	10X8X80mm	14X9X100mm	20X12X50mm
4X4X20mm	6X6X90mm	10X8X90mm	14X9X110mm	20X12X60mm
4X4X25mm	6X6X100mm	10X8X100mm	14X9X125mm	20X12X70mm
4X4X30mm	8X7X20mm	10X8X110mm	14X9X140mm	20X12X80mm
4X4X36mm	8X7X25mm	10X8X125mm	16X10X40mm	20X12X90mm
4X4X40mm	8X7X30mm	12X8X30mm	16X10X45mm	20X12X100mm
5X5X16mm	8X7X36mm	12X8X36mm	16X10X50mm	20X12X110mm
5X5X20mm	8X7X40mm	12X8X40mm	16X10X60mm	20X12X120mm
5X5X25mm	8X7X45mm	12X8X45mm	16X10X70mm	20X12X130mm
5X5X30mm	8X7X50mm	12X8X50mm	16X10X80mm	20X12X140mm
5X5X36mm	8X7X60mm	12X8X60mm	16X10X90mm	22X14X60mm
5X5X40mm	8X7X70mm	12X8X70mm	16X10X100mm	22X14X70mm
5X5X45mm	8X7X80mm	12X8X80mm	16X10X125mm	22X14X80mm
5X5X50mm	8X7X90mm	12X8X90mm	18X11X40mm	22X14X90mm
5X5X60mm	8X7X100mm	12X8X100mm	18X11X50mm	22X14X100mm
6X6X16mm	8X7X110mm	12X8X125mm	18X11X60mm	22X14X125mm
6X6X20mm	8X7X125mm	14X9X30mm	18X11X70mm	22X14X140mm
6X6X25mm	8X7X140mm	14X9X36mm	18X11X80mm	22X14X150mm
6X6X30mm	10X8X30mm	14X9X40mm	18X11X90mm	25X14X70mm
6X6X36mm	10X8X36mm	14X9X45mm	18X11X100mm	25X14X80mm
6X6X40mm	10X8X40mm	14X9X50mm	18X11X110mm	25X14X90mm
6X6X45mm	10X8X45mm	14X9X60mm	18X11X120mm	25X14X100mm
6X6X50mm	10X8X50mm	14X9X70mm	18X11X130mm	25X14X120mm
6X6X60mm	10X8X60mm	14X9X80mm	18X11X140mm	25X14X140mm
6X6X70mm	10X8X70mm	14X9X90mm	18X11X150mm	28X16X125mm

Σφήνες ίσιες 1 μέτρου

Τύπος	Τύπος
5X5mm	14X9mm
6X6mm	16X10mm
8X7mm	18X11mm
10X8mm	20X12mm
12X8mm	



Σφήνες μισοφέγγαρες

Τύπος	Τύπος	Τύπος
3X5mm	5X9mm	10X13mm
3X6,5mm	6X7,5mm	10X16mm
4X5mm	6X9mm	
4X6,5mm	6X11mm	
4X7,5mm	8X11mm	
5X6,5mm	8X13mm	
5X7,5mm	10X11mm	



Ντίζες τραπεζοειδείς 1m

Κωδικός	Πάσο	Κωδικός	Πάσο
103C1510	10x3	103C1530	30x6
103C1512	12x3	103C1532	32x6
103C1514	14x3	103C1536	36x6
103C1516	16x4	103C1540	40x7
103C1518	18x4	Μολυβδούχος χάλυβας C15	
103C1520	20x4		
103C1522	22x5		
103C1524	24x5		
103C1526	26x5		
103C1528	28x5		



Made in FI.

Τραπεζοειδή παξιμάδια

Κωδικός	Πάσο	Κωδικός	Πάσο
D22L15	10x3mm	D60L45	30x6mm
D26L18	12x3mm	D60L48	32x6mm
D30L21	14x3mm	D75L54	36x6mm
D36L24	16x4mm	D80L60	40x7mm
D40L27	18x4mm	Μολυβδούχος χάλυβας C15	
D45L30	20x4mm		
D45L33	22x5mm		
D50L36	24x5mm		
D50L39	26x5mm		
D60L42	28x5mm		



Made in FI.

Πόμολα μαργαρίτα με αρσενικό πάσο

Βακελίτης με αντοχή σε διαλύτες, λάδια, γράσα και χημικά PF. 7 λοβοί.

Κωδικός	Τύπος	Πάσο	Κωδικός	Τύπος	Πάσο
B1V7M300620	30mm	M6X20mm	B1V7M500820	50mm	M8X20mm
B1V7M300630	30mm	M6X30mm	B1V7M500830	50mm	M8X30mm
B1V7M300815	30mm	M8X15mm	B1V7M500840	50mm	M8X40mm
B1V7M300825	30mm	M8X25mm	B1V7M501030	50mm	M10X30mm
B1V7M400630	40mm	M6X30mm	B1V7M501040	50mm	M10X40mm
B1V7M400640	40mm	M6X40mm	B1V7M501240	50mm	M12X40mm
B1V7M400820	40mm	M8X20mm	B1V7M600840	60mm	M8X40mm
B1V7M400830	40mm	M8X30mm	B1V7M601030	60mm	M10X30mm
B1V7M400840	40mm	M8X40mm	B1V7M601050	60mm	M10X50mm
B1V7M400850	40mm	M8X50mm	B1V7M601240	60mm	M12X40mm
B1V7M401030	40mm	M10X30mm	B1V7M601250	60mm	M12X50mm
B1V7M401040	40mm	M10X40mm			

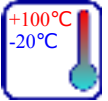
**Ιταλίας****Πόμολα μαργαρίτα με αρσ. πάσο INOX AISI 304**

Βακελίτης με αντοχή σε διαλύτες, λάδια, γράσα και χημικά PF. 7 λοβοί.

Κωδικός	Τύπος	Πάσο
B1V7MX300430	30mm	M4X30mm
B1V7MX300620	30mm	M6X20mm
B1V7MX400630	40mm	M6X30mm
B1V7MX401030	40mm	M10X30mm
B1V7MX501040	50mm	M10X40mm

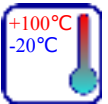
**Ιταλίας****Πόμολα μαργαρίτα από PF Duroplast με αρσενικό πάσο**

Ανθεκτικά σε έλαια, λίπη, καύσιμα και διαλύτες. 6 λοβοί.

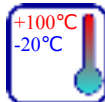

Κωδικός	Τύπος	Πάσο
01PF2B20	PF2 M5X20	20mm M5X20mm
01PF2B30	PF2 M5X30	20mm M5X30mm
01PF3P25	PF3 M8X25	30mm M8X25mm
01PF4C25	PF4 M6X25	40mm M6X25mm
01PF4C40	PF4 M6X40	40mm M6X40mm
01PF4D20	PF4 M8X20	40mm M8X20mm
01PF4D40	PF4 M8X40	40mm M8X40mm
01PF5D20	PF4 M8X20	50mm M8X20mm
01PF5D35	PF5 M8X35	50mm M8X35mm
01PF6E50	PF6 M10X50	50mm M10X40mm
01PF6D25	PF6 M8X25	60mm M8X25mm
01PF6D40	PF6 M8X40	60mm M8X40mm
01PF6E30	PF6 M10X30	60mm M10X30mm
01PF6E70	PF6 M10X70	60mm M10X70mm
01PF6F35	PF6 M12X35	60mm M12X35mm

**Ιταλίας****Πόμολα μαργαρίτα από PF Duroplast με αρσενικό πάσο INOX**

Ανθεκτικά σε έλαια, λίπη, καύσιμα και διαλύτες. 6 λοβοί.

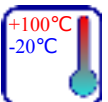

Κωδικός	Τύπος	Πάσο
01PF2B20X	PF2 M5X20	20mm M5X20mm
01PF2B30X	PF2 M5X30	20mm M5X30mm
01PF2B40X	PF2 M5X40	20mm M5X40mm
01PF2C20X	PF2 M6X20	20mm M6X20mm
01PF2C30X	PF2 M6X30	20mm M6X30mm
01PF2C40X	PF2 M6X40	20mm M6X40mm
01PF3D15X	PF3 M8X15	30mm M8X15mm
01PF3D25X	PF3 M8X25	30mm M8X25mm
01PF4C25X	PF4 M6X25	40mm M6X25mm

**Ιταλίας**

**Λεβιέδες καστανίας από πολυαμίδιο με αρσενικό πάσο**

Ανθεκτικά σε έλαια, λίπη, καύσιμα και διαλύτες.

Κωδικός	Τύπος	Πάσο
0155C15	KP-P55 M6X15	55mm M6X15mm
0155C30	KP-P55 M6X30	55mm M6X30mm
0155D15	KP-P55 M8X15	55mm M8X15mm
0155D30	KP-P55 M8X30	55mm M8X30mm
0179D20	KP-P79 M8X20	80mm M8X20mm
0179D30	KP-P79 M8X30	80mm M8X30mm
0179D40	KP-P79 M8X40	80mm M8X40mm
0179E25	KP-P79 M10X25	80mm M10X25mm
0179E35	KP-P79 M10X35	80mm M10X35mm
0179E50	KP-P79 M10X50	80mm M10X50mm
0179F25	KP-P79 M12X25	80mm M12X25mm
0179F40	KP-P79 M12X40	80mm M12X40mm
0179F50	KP-P79 M12X50	80mm M12X50mm

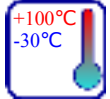
**Ιταλίας****Πόμολα μαργαρίτα από PF Duroplast με θηλυκό πάσο**

Ανθεκτικά σε έλαια, λίπη, καύσιμα και διαλύτες. 6 λοβοί.

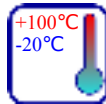

Κωδικός	Διάμετρος	Πάσο
01PB2A	PB2 M4 20mm	M4
01PB2B	PB2 M5 20mm	M5
01PB2C	PB2 M6 20mm	M6
01PB3B	PB3 M5 30mm	M5
01PB4F	PB4 M12 40mm	M12
01PB6F	PB6 M12 60mm	M12
01PB7E	PB7 M10 70mm	M10
01PB7F	PB7 M12 70mm	M12

**Ιταλίας****Πόμολα μαργαρίτα από PF Duroplast με διαμπερές πάσο**

Ανθεκτικά σε έλαια, λίπη, καύσιμα και διαλύτες.

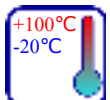

Με 7 λοβούς		
Κωδικός	Τύπος	Πάσο
B1V7BP3004	30mm	M4
B1V7BP3005	30mm	M5
B1V7BP4006	40mm	M6
B1V7BP5008	50mm	M8
B1V7BP5010	50mm	M10
B1V7BP5012	50mm	M12

**Ιταλίας****Πόμολα μαργαρίτα με θηλυκό πάσο**

Βακελίτης με αντοχή σε διαλύτες, λάδια, γράσα και χημικά PF. 7 λοβοί.

Κωδικός	Τύπος	Πάσο
B1V7B3006	30mm	M6
B1V7B3008	30mm	M8
B1V7B4006	40mm	M6
B1V7B4008	40mm	M8
B1V7B4010	40mm	M10
B1V7B5008	50mm	M8
B1V7B5010	50mm	M10
B1V7B6010	60mm	M10
B1V7B7010	70mm	M10
B1V7B7012	70mm	M12
B1V7B7014	70mm	M14

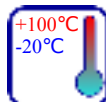
**Ιταλίας****Λεβιέδες καστανίας από πολυαμίδιο με θηλυκό πάσο**

Ανθεκτικά σε έλαια, λίπη, καύσιμα και διαλύτες.

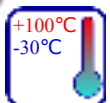

Κωδικός	Τύπος	Πάσο
0155C	KP-B55 M6	55mm M6
0155D	KP-B55 M8	55mm M8
0179D	KP-B79 M8	80mm M8
0179E	KP-B79 M10	80mm M10
0179F	KP-B79 M12	80mm M12

Ιταλίας

Βολάν σκέτα με 4 ακτίνες

Με μασίφ κορμό

Κωδικός **Διάμετρος**

B1VL100	100mm
B1VL120	120mm
B1VL140	140mm
B1VL160	160mm
B1VL200	200mm

**Ιταλίας****Βολάν με υπομόγλιο και 4 ακτίνες**

Με μασίφ κορμό

Κωδικός **Διάμετρος**

B1VLG100	100mm
B1VLG120	120mm
B1VLG140	140mm
B1VLG160	160mm
B1VLG200	200mm

**Ιταλίας****Χειρολαβές πόρτας νάιλον τύπου Π**

Αντοχή σε διαλύτες, λάδια και γράσα

**Κωδικός** **Μήκος** **Τρύπες**

B1MPP10711	107mm	93,5±0,5mm
B1MPP13614	136mm	117±0,5mm
B1MPP15114	151mm	132±0,5mm
B1MPP19714	197mm	179±0,5mm

Ιταλίας**Μεντεσέδες νάιλον (πολυαμίδιο)****Κωδικός** **Τύπος** **Τρύπες**

A3CC40	40X38,5mm	25mm
A3CC48	49,5X47mm	30mm
A3CC65	65X64,3mm	40mm
A3CC98	98X96,5mm	60mm

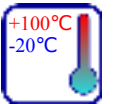
**Ιταλίας****Μακρόστενες χειρολαβές βακελίτου**

Θηλυκό πάσο

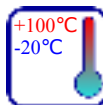
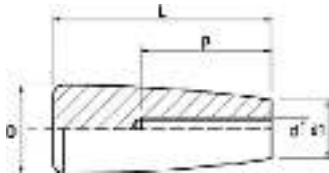
**Κωδικός** **D** **d** **L** **d1** **P**

B1MO6406	26mm	M6	64mm	17mm	35mm
B1MO6408	26mm	M8	64mm	17mm	26mm
B1MO6410	26mm	M10	64mm	17mm	29mm
B1MO8408	33mm	M8	84mm	21mm	45mm
B1MO8410	33mm	M10	84mm	21mm	45mm
B1MO8412	33mm	M12	84mm	21mm	45mm

Ιταλίας**Σφαιρικά πόμολα από πολυαμίδιο με θηλυκό πάσο**

Ανθεκτικά σε έλαια, λίπη, καύσιμα και διαλύτες.

**Κωδικός** **Τύπος** **Πάσο**

01SSF25C	SSFD.25 M6	25mm	M6
01SSF25D	SSFD.25 M8	25mm	M8
01SSF35D	SSFD.35 M8	35mm	M8
01SSF40D	SSFD.40 M8	40mm	M8
01SSF45D	SSFD.45 M8	45mm	M8
01SSF40E	SSFD.40 M10	40mm	M10
01SSF45E	SSFD.45 M10	45mm	M10
01SSF40F	SSFD.40 M12	40mm	M12
01SSF45F	SSFD.45 M12	45mm	M12

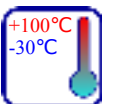
**Ιταλίας****Μακρόστενες χειρολαβές βακελίτου NEO**

Αρσενικό γαλβανιζέ πάσο

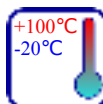
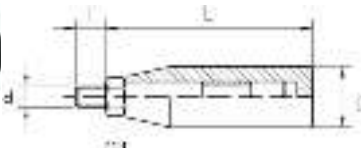
**Κωδικός** **D** **d** **l** **L** **CH**

B1IC1806	18mm	M6	12mm	51mm	10mm
B1IC2008	20mm	M8	15mm	71mm	12mm
B1IC2410	24mm	M10	15mm	81mm	13mm
B1IC2812	28mm	M12	15mm	90mm	14mm

Ιταλίας**Πόμολα μαργαρίτα μίνι με αρσενικό πάσο**

Ανθεκτικά σε έλαια, λίπη, καύσιμα και διαλύτες. 9 λοβοί.

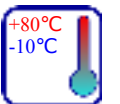
**Κωδικός** **Τύπος**

B1V9M200520	Ø20 M5X20
B1V9M200620	Ø20 M6X20

Ιταλίας

Πέλματα βάσεις σταθερές Ø30-Ø50

Γαλβανιζέ βίδα

Πόδι: Fiberglass reinforced nylon

Κωδικός	A	M	B	H	Αντοχή
A3E1	Ø32	M8	26mm	16mm	≤300daN
A3E4	Ø40	M10	33mm	16mm	≤400daN
A3EB30/0630	Ø30	M6	30mm	16mm	≤150daN
A3EB50/1030	Ø50	M10	30mm	16mm	≤150daN

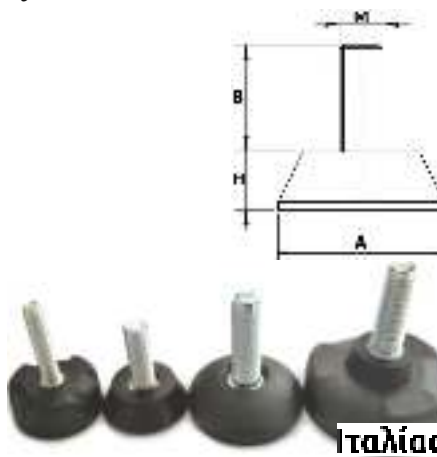

Ιταλίας

Αντιολισθητικά λάστιχα πελμάτων



Κωδικός	Τύπος
7263 [11852]	Ø40mm
7264 [11777]	Ø50mm
7265 [11778]	Ø60mm
7266 [11428]	Ø80mm
7267 [11779]	Ø100mm

Ιταλίας

Πέλματα βάσεις Ø40-Ø60

Γαλβανιζέ

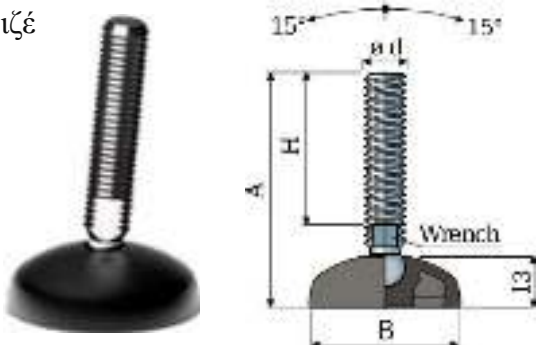

Κωδικός	B	Ø d	A	H	Αντοχή
10/7392	Ø40	M8	88mm	65mm	≤10000N
10/7002	Ø40	M10	95mm	70mm	≤11000N
15/7020	Ø50	M10	95mm	70mm	≤12000N
15/7400	Ø50	M12	105mm	77mm	≤13000N
18/7406	Ø60	M12	109mm	77mm	≤14000N
18/7050	Ø60	M14	94mm	61mm	≤15000N
18/7054	Ø60	M16	95mm	60mm	≤17000N

Ιταλίας

Πέλματα βάσεις Ø80-Ø124

Γαλβανιζέ

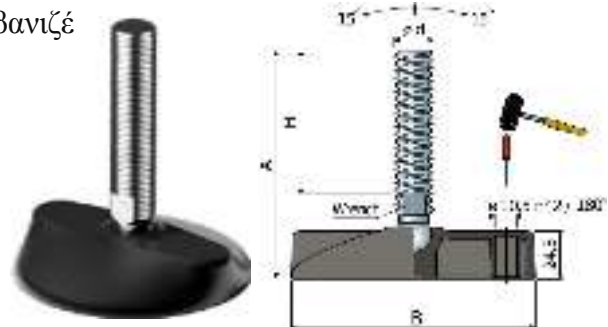

Κωδικός	B	Ø d	A	H	Αντοχή
25/7460	Ø80	M12	111mm	77mm	≤15000N
25/7084	Ø80	M14	96mm	61mm	≤16000N
25/7086	Ø80	M14	126mm	91mm	≤16000N
25/7462	Ø80	M16	127mm	90mm	≤19000N
38/7112	Ø102	M16	145mm	105mm	≤22000N
38/7118	Ø102	M20	130mm	86mm	≤24000N
45/7142	Ø124	M20	164mm	116mm	≤27000N
45/7148	Ø124	M24	170mm	122mm	≤29000N

Ιταλίας

Πέλματα βάσεις Ø40-Ø60

INOX AISI 304

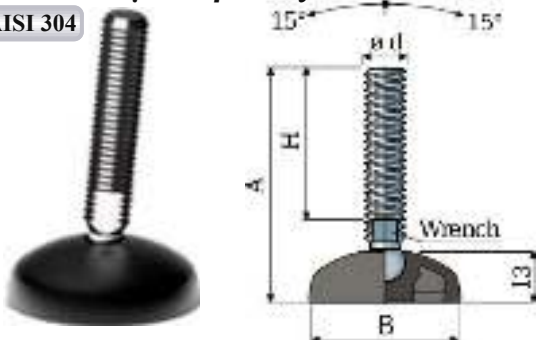

Κωδικός	B	Ø d	A	H	Αντοχή
10/7393	Ø40	M8	88mm	65mm	≤10000N
10/7003	Ø40	M10	95mm	70mm	≤11000N
15/7021	Ø50	M10	95mm	70mm	≤12000N
15/7401	Ø50	M12	105mm	77mm	≤13000N
18/7045	Ø60	M12	94mm	63mm	≤14000N
18/7051	Ø60	M14	94mm	61mm	≤15000N

Ιταλίας

Πέλματα βάσεις Ø80-Ø124

INOX AISI 304

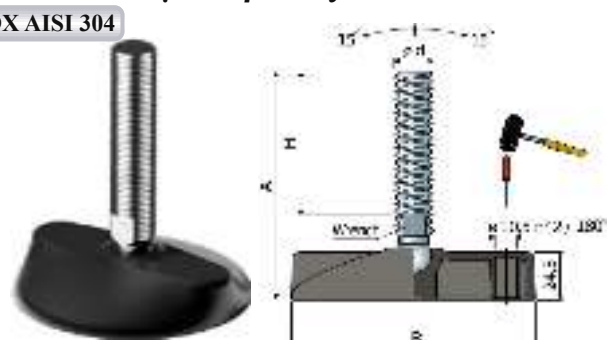

Κωδικός	B	Ø d	A	H	Αντοχή
25/7079	Ø80	M12	96mm	63mm	≤15000N
25/7087	Ø80	M14	126mm	91mm	≤16000N
25/7463	Ø80	M16	127mm	90mm	≤19000N
38/7113	Ø102	M16	145mm	105mm	≤22000N
38/7121	Ø102	M20	160mm	116mm	≤24000N

Ιταλίας

Τάπες εξάγωνων περικόχλιων από πολυαιθυλένιο

Ανθεκτικά σε έλαια, λίπη, καύσιμα και διαλύτες.

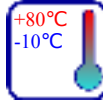

Κωδικός	ΜΒ	Μ
01MB6	MB 6	M6
01MB8	MB 8	M8
01MB10	MB 10	M10
01MB12	MB 12	M12

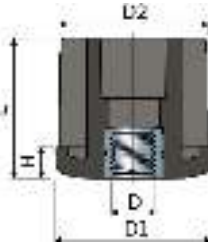
Ιταλίας**Τάπες στρόγγυλες**

Κωδικός	D	D1	D2	H	L	Αντοχή
64/80858	M10	30	Ø27	6	31	≤5000N
64/7210	M10	38	Ø35	8	38	≤5000N
64/7214	M10	42,4	Ø39,4	8	38	≤7000N

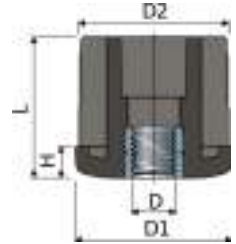
Ιταλίας**Τάπες τετράγωνες**

Κωδικός	D	D1	D2	H	L	Αντοχή
68/7232	M10	30	27	6	31	≤5000N
68/7236	M10	35	32	8	38	≤7000N
68/7241	M10	40	37	8	38	≤7500N
68/7244	M16	40	37	8	38	≤9000N

Ιταλίας**Μαγνήτες νεοδιμίου 35N στρόγγυλοι**

Κωδικός	Τύπος	Δύναμη	Κωδικός	Τύπος	Δύναμη
MANE82	Ø8X2	0,7kg	MANE205	Ø20X5	6,5kg
MANE102	Ø10X2	1kg	MANE256	Ø25X6	9,7kg
MANE103	Ø10X3	1,5kg	MANE305	Ø30X5	9,9kg
MANE122	Ø12X2	1,3kg	MANE306	Ø30X6	11kg
MANE123	Ø12X3	2,1kg	MANE405	Ø40X5	11,8kg
MANE153	Ø15X3	2,7kg			
MANE203	Ø20X3	3,6kg			

Μαγνήτες νεοδιμίου 35N τετράγωνοι

Κωδικός	Τύπος	Δύναμη
MANE10102	10X10X2	1,1kg
MANE10103	10X10X3	1,9kg
MANE12124	12X12X4	3,2kg
MANE15155	15X15X5	5,3kg
MANE20205	20X20X5	7,7kg
MANE25255	25X25X5	9,5kg
MANE30306	30X30X6	11,5kg

Μαγνήτες νεοδιμίου 35N κυλινδρικοί

Κωδικός	Τύπος	Δύναμη
MANE4020	Ø40X20	40kg
MANE5020	Ø50X20	60kg
MANE5030	Ø50X30	84kg
MANE7030	Ø70X30	146kg
MANE7035	Ø70X35	160kg

Μαγνήτες νεοδιμίου 35N με τρύπα

Φρέζα τρύπας 90°



Κωδικός	Τύπος	Τρύπα	Διακτύλιος teflon	Δύναμη
	Ø10X5mm	Ø3mm	✗	2kg
	Ø12X5mm	Ø3mm	✗	2,5kg
	Ø16X5mm	Ø3mm	✗	4,3kg
	Ø20X6mm	Ø4mm	✓	6kg
	Ø25X7mm	Ø5mm	✓	9kg



Σφυγκτήρες κολάρων με πλαστική πεταλούδα



Κωδικός	Τύπος
122-12309-012	Ø8-12mm
122-12309-016	Ø10-16mm
122-12309-022	Ø12-22mm



Βιδωτά κολάρα σφυγκτήρες γαλβανιζέ



Κωδικός	Πάχος	Διάμετρος
W108-16/9	9mm	8-12mm
	9mm	8-16mm
W110-16/9	9mm	10-16mm
W112-22/9	9mm	12-22mm
W116-27/25	9mm	16-27mm
W140-60/9	9mm	40-60mm
	9mm	50-70mm
	9mm	60-80mm
	9mm	70-90mm
	9mm	80-100mm
	9mm	90-110mm



Βιδωτά κολάρα σφυγκτήρες γαλβανιζέ

Κωδικός	Πάχος	Διάμετρος
W116-27	12mm	16-27mm
W120-32	12mm	20-32mm
W125-40	12mm	25-40mm
W135-50	12mm	35-50mm
W140-60	12mm	40-60mm
W150-70	12mm	50-70mm
W160-80	12mm	60-80mm
W170-90	12mm	70-90mm
W180-100	12mm	80-100mm
W190-110	12mm	90-110mm
	12mm	100-120mm
W1110-130	12mm	110-130mm
W1120-140	12mm	120-140mm
W1130-150	12mm	130-150mm
W1140-160	12mm	140-160mm
	12mm	160-180mm
W1180-200	12mm	180-200mm
W1200-220	12mm	200-220mm
W1240-260	12mm	240-260mm
W1300-320	12mm	300-320mm



Βιδωτά κολάρα σφυγκτήρες γαλβανιζέ

Κωδικός	Πάχος	Διάμετρος	Κωδικός	Πάχος	Διάμετρος	Κωδικός	Πάχος	Διάμετρος
W123-25	18mm	23-25mm	W163-68	20mm	63-68mm	W1162-174	30mm	162-174mm
W125-27	18mm	25-27mm	W168-73	25mm	68-73mm	W1174-187	30mm	174-187mm
W127-29	18mm	27-29mm	W173-79	25mm	73-79mm	W1187-200	30mm	187-200mm
W129-31	18mm	29-31mm	W179-85	25mm	79-85mm			
W131-34	18mm	31-34mm	W185-91	25mm	85-91mm			
W134-37	18mm	34-37mm	W191-97	25mm	91-97mm			
W137-40	18mm	37-40mm	W197-104	25mm	97-104mm			
W140-43	18mm	40-43mm	W1104-112	25mm	104-112mm			
W143-47	20mm	43-47mm	W1112-121	25mm	112-121mm			
W147-51	20mm	47-51mm	W1121-130	25mm	121-130mm			
W151-55	20mm	51-55mm	W1130-140	30mm	130-140mm			
W155-59	20mm	55-59mm	W1140-150	30mm	140-150mm			
W159-63	20mm	59-63mm	W1150-162	25mm	150-162mm			



**Βιδωτά κολάρα σφυγκτήρες INOX W4**

Κωδικός	Πάχος	Διάμετρος
W27-11/5	5mm	7-11mm (Inox βέργα)
W408-16/9	9mm	8-16mm
W412-22/9	9mm	12-22mm
W416-27/9	9mm	16-27mm
W420-32/9	9mm	20-32mm
W425-40/9	9mm	25-40mm
W432-50/9	9mm	32-50mm
W440-60/9	9mm	40-60mm

**Βιδωτά κολάρα σφυγκτήρες INOX W4**

Κωδικός	Πάχος	Διάμετρος
W416-27/12	12mm	16-27mm
W420-32/12	12mm	20-32mm
W425-40/12	12mm	25-40mm
W430-45/12	12mm	30-45mm
W435-50/12	12mm	35-50mm
W440-60/12	12mm	40-60mm
W450-70/12	12mm	50-70mm
W460-80/12	12mm	60-80mm
W470-90/12	12mm	70-90mm
W480-100/12	12mm	80-100mm
W490-110/12	12mm	90-110mm
W4100-120/12	12mm	100-120mm
W4110-130/12	12mm	110-130mm
W4120-140/12	12mm	120-140mm
W4140-160/12	12mm	140-160mm

**Βιδωτά κολάρα σφυγκτήρες BT INOX W4**

Κωδικός	Πάχος	Διάμετρος	Κωδικός	Πάχος	Διάμετρος
W423-25/18	18mm	23-25mm	W468-73/25	25mm	68-73mm
W425-27/18	18mm	25-27mm	W473-79/25	25mm	73-79mm
W427-29/18	18mm	27-29mm	W479-85/25	25mm	79-85mm
W429-31/18	18mm	29-31mm	W485-91/25	25mm	85-91mm
W431-34/18	18mm	31-34mm	W491-97/25	25mm	91-97mm
W434-37/18	18mm	34-37mm	W494-104/25	25mm	97-104mm
W437-40/18	18mm	37-40mm	W4104-112/25	25mm	104-112mm
W440-43/18	18mm	40-43mm	W4112-121/25	25mm	112-121mm
W443-47/20	20mm	43-47mm	W4121-130/25	25mm	121-130mm
W447-51/20	20mm	47-51mm	W4130-140/30	30mm	130-140mm
W451-55/20	20mm	51-55mm	W4150-162/30	30mm	150-162mm
W455-59/20	20mm	55-59mm	W4162-174/30	30mm	162-174mm
W459-63/20	20mm	59-63mm	W4174-187/30	30mm	174-187mm
W463-68/20	20mm	63-68mm	W4187-200/30	30mm	187-200mm

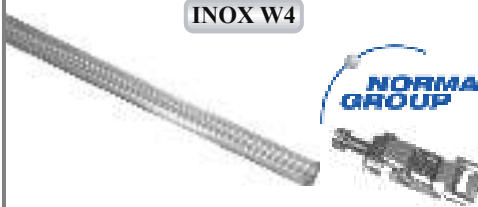
**Βιδωτά κολάρα σφυγκτήρες ανοξείδωτα ρολλό 30 μέτρων INOX W4**

Κωδικός	Τύπος
W430M	Κολάρο ρολλό 30 μέτρων πλάτος 9mm
W4CD50	Κεφαλές σφυγκτήρα κολάρων (τεμάχιο)

**Βιδωτά κολάρα σφυγκτήρες ανοξείδωτα ρολλό 30 μέτρων INOX W2**

Κωδικός	Τύπος
38012009	Κολάρο ρολλό 30 μέτρων πλάτος 9mm
38011009	Κεφαλές σφυγκτήρα κολάρων (τεμάχιο)

FRULSIDER

Κολάρα σφυγκτήρες INOX W2

25 τεμάχια



Κωδικός	Τύπος
2AFI200	4,6x200mm
2AFI300	4,6x300mm
2AFI350	4,6x350mm

**Σφυγκτήρες φούσκας ημιαξονίου INOX W4**

Κωδικός	Τύπος
01605	Ø25-50mm
01612	Ø40-120mm



Εξάγωνες βίδες DIN933 & DIN931 σε μετρικό INOX A2

Πάχος→	4mm	5mm	6mm	8mm	10mm	12mm	14mm	16mm	18mm	20mm	24mm
Βήμα→	0,70	0,80	1,00	1,25	1,50	1,75	2,00	2,00	2,50	2,50	3,00
↓Μήκος↓											
8		✓									
10	✓	✓	✓	✓							
12	✓	✓	✓	✓							
16	✓	✓	✓	✓	✓						
20	✓	✓	✓	✓	✓	✓					
25	✓	✓	✓	✓	✓	✓	✓				
30	✓	✓	✓	✓	✓	✓	✓	✓	✓	✓	
35	✓	✓	✓	✓	✓	✓	✓	✓	✓	✓	
40	✓	✓	✓	✓	✓	✓	✓	✓	✓	✓	
45	✓	✓	✓	✓	✓	✓	✓	✓	✓	✓	
50	✓	✓	✓	✓	✓	✓	✓	✓	✓	✓	✓
55			✓	✓	✓	✓	✓				
60	✓	✓	✓	✓	✓	✓	✓	✓	✓	✓	✓
65				✓	✓	✓					
70		✓	✓	✓	✓	✓	✓	✓	✓	✓	✓
80			✓	✓	✓	✓	✓	✓	✓	✓	✓
90			✓	✓	✓	✓	✓	✓	✓	✓	✓
100			✓	✓	✓	✓	✓	✓	✓	✓	✓
110			✓	✓	✓	✓	✓	✓	✓	✓	✓
120			✓	✓	✓	✓	✓	✓	✓	✓	✓
130				✓	✓	✓	✓	✓	✓	✓	✓
140				✓	✓	✓	✓	✓	✓	✓	✓
150				✓	✓	✓	✓	✓	✓	✓	✓
160				✓	✓	✓	✓	✓		✓	
180				✓	✓	✓	✓	✓		✓	
200				✓	✓	✓		✓		✓	
220						✓					

Εξάγωνες βίδες σε ίντσες INOX A2

Πάχος→	1/4"	5/16"	3/8"	1/2"	Πάχος→	1/4"	5/16"	3/8"	1/2"
↓Μήκος↓					↓Μήκος↓				
12	✓	✓			60			✓	
16	✓	✓			70			✓	
20	✓	✓	✓		75			✓	
25	✓	✓	✓	✓	87			✓	
32	✓	✓	✓	✓	100			✓	✓
38	✓	✓	✓	✓	110				✓
45	✓	✓	✓	✓					
50	✓	✓	✓	✓					



Ντίτζες DIN976 1 μέτρου INOX A2

Πάχος	Πάχος
3	16
4	18
5	20
6	22
8	24
10	27
12	30
14	33



Ντίτζες DIN976 1 μέτρου ίντζας INOX A2

Πάχος	Πάχος
5/16"	5/8"
7/16"	3/4"
1/2"X13	7/8"
9/16"	1"



Ανοξείδωτα περικόχλια DIN934 INOX A2

Πάχος	Πάχος
M2	M16
M2,5	M18
M3	M20
M4	M22
M5	M24
M6	M27
M8	M30
M10	M33
M12	M36
M14	



Περικόχλια ασφαλείας DIN985 INOX A2

Πάχος	Πάχος
M3	M14
M4	M16
M5	M18
M6	M20
M8	M22
M10	M24
M12	



Περικόχλια ψιλόπασα DIN934 INOX A2

Πάσο
M8X1
M10X1
M10X1,25
M12X1,25
M12X1,5
M14X1,5
M16X1,5
M18X1,5
M20X1,5



Περικόχλια στενά DIN439 INOX A2

Πάσο	Πάσο
M4	M14
M5	M16
M6	M18
M8	M20
M10	
M12	



Περικόχλια τυφλά DIN1587 INOX A2

Πάσο	Πάσο
M3	M12
M4	M14
M5	M16
M6	M18
M8	M20
M10	



Περικόχλια πεταλούδες DIN315AF INOX A2

Πάσο
M3
M4
M5
M6
M8
M10
M12
M14
M16



**Περικόγλια τετράγωνα DIN557** INOX A2**Πάσο**M6
M8
M10
M12**Περικόγλια DIN934** INOX A2

αριστερόστροφα

ΠάσοM5
M6
M8
M10
M12
M16
M20**Περικόγλια μούφες DIN6634** INOX A2**Πάσο**M6
M8
M10
M12
M16
M20**Περικόγλια αντικλεπτικά WS9305** INOX A2

*αποσπώμενα

ΠάσοM6
M8
M10
M12**Περικόγλια φλαντζωτά WS9345** INOX A2**Πάσο**M5
M6
M8
M10
M12**Περικόγλια ασφαλείας DIN980** INOX A2

*χωρίς πλαστικό

ΠάσοM6
M8
M10
M12

Ροδέλες DIN125 INOX A2**Τύπος Τύπος**

3X7	18X34
4X9	20X37
5X10	22X39
6X13	24X44
8X17	27X50
10X21	30X56
12X24	33X60
14X28	36X66
16X30	

**Ροδέλες φαρδιές DIN9021** INOX A2**Τύπος Τύπος**

3X9	16X50
4X12	18X56
5X15	20X60
6X18	22X66
8X25	24X72
10X30	27X81
12X40	
14X45	

**Γκρόβερ DIN127B** INOX A2**Οπή Οπή**

3	16
4	18
5	20
6	22
8	24
10	27
12	30
14	

**Γκρόβερ αστέρι DIN6798A** INOX A2**Οπή**

3
4
5
6
8
10
12
14
16

**Ροδέλες XL (4xD)** INOX A2**Οπή**

4X16
5X20
6X24
8X32
10X40
12X48

**Πιατάκια μασίφ WS9255** INOX A2**Οπή**

3
4
5
6
8
10
12





Μηχανόβιδες τραπεζοειδείς DIN7985 INOX A2



Πάχος→	2	2,5	3	4	5	6	8
↓Μήκος↓							
4			✓				
6	✓	✓	✓	✓			
7	✓	✓					
8	✓	✓	✓	✓	✓		
10	✓	✓	✓	✓	✓		
12	✓	✓	✓	✓	✓	✓	
16	✓	✓	✓	✓	✓	✓	✓
20	✓	✓	✓	✓	✓	✓	✓
25			✓	✓	✓	✓	✓
30			✓	✓	✓	✓	✓
35				✓	✓	✓	✓
40			✓	✓	✓	✓	✓
45					✓	✓	✓
50				✓	✓	✓	✓
60				✓	✓	✓	✓
70					✓	✓	
80					✓	✓	
100						✓	

Μηχανόβιδες φρεζάτες DIN965 INOX A2



Πάχος→	2	2,5	3	4	5	6	8
↓Μήκος↓							
4			✓				
6	✓	✓	✓	✓			
7	✓	✓					
8	✓	✓	✓	✓	✓		
10	✓	✓	✓	✓	✓		
12	✓	✓	✓	✓	✓	✓	
16	✓	✓	✓	✓	✓	✓	✓
20	✓	✓	✓	✓	✓	✓	✓
25			✓	✓	✓	✓	✓
30			✓	✓	✓	✓	✓
35				✓	✓	✓	✓
40			✓	✓	✓	✓	✓
45				✓	✓	✓	✓
50				✓	✓	✓	✓
60				✓	✓	✓	✓
70					✓	✓	
80					✓	✓	
100						✓	

Μηχανόβιδες φακής DIN966 INOX A2



Πάχος→	3	4	5	6
↓Μήκος↓				
6	✓	✓		
8	✓	✓		
10	✓	✓	✓	✓
12	✓	✓	✓	✓
16	✓	✓		✓
20	✓	✓	✓	✓
25	✓	✓	✓	✓
30	✓	✓	✓	✓
35		✓	✓	✓
40		✓	✓	✓
50				✓
60			✓	✓

Μηχανόβιδες φρεζάτες DIN963 INOX A2



Πάχος→	3	4	5	6	8	10
↓Μήκος↓						
3-7	✓	✓	✓			
8	✓	✓	✓			
10	✓	✓	✓	✓		
12	✓	✓	✓	✓		
16	✓	✓	✓	✓		
20	✓	✓	✓	✓		
25	✓	✓	✓	✓		
30	✓	✓	✓	✓		
35	✓	✓	✓	✓		
40						
45			✓	✓		
50		✓	✓	✓		
60		✓	✓	✓		
70				✓		
80				✓	✓	✓
90				✓	✓	
100				✓	✓	✓
120					✓	✓

Μηχανόβιδες πλατυκέφαλες WS9330

INOX A2



(Τσιγκόβιδες)



Πάχος→	3	4	5	6	8
↓Μήκος↓					
10	✓	✓	✓	✓	
12	✓	✓	✓	✓	
16	✓	✓	✓	✓	✓
20	✓	✓	✓	✓	✓
25	✓	✓	✓	✓	✓
30	✓	✓	✓	✓	✓
35			✓	✓	✓
40		✓	✓	✓	✓
50			✓	✓	✓
60			✓	✓	✓

Μηχανόβιδες τραπεζοειδείς DIN84

INOX A2

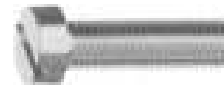

Πάχος→	3	4	5	6
↓Μήκος↓				
3-8	✓	✓	✓	
10	✓	✓	✓	✓
12	✓	✓	✓	✓
16	✓	✓	✓	✓
20	✓	✓	✓	✓
25	✓	✓	✓	✓
30	✓	✓	✓	✓
35		✓	✓	✓
40			✓	✓
45			✓	✓
50			✓	✓
60			✓	✓

Μηχανόβιδες πομπέ WS9460

INOX A2



Πάχος→	4	5	6
↓Μήκος↓			
8	✓	✓	
10	✓	✓	✓
12	✓	✓	✓
16			✓
25	✓	✓	
30	✓	✓	✓
35		✓	✓
40		✓	✓

Μηχανόβιδες φρεζάτες WS9470

INOX A2



Πάχος→	4	5	6
↓Μήκος↓			
10	✓	✓	
12		✓	✓
16		✓	
20		✓	
25		✓	✓
30			✓

Μηχανόβιδες πεταλούδα DIN316AF

INOX A2



Πάχος→	4	5	6	8
↓Μήκος↓				
16	✓	✓	✓	✓
20	✓	✓	✓	✓
25	✓	✓	✓	✓
30	✓	✓	✓	✓
40			✓	✓
50			✓	✓

Κασονόβιδες DIN603

INOX A2

Πάχος→	6	8	10	12	Πάχος→	6	8	10	12
↓Μήκος↓					↓Μήκος↓				
20	✓	✓			90	✓	✓	✓	✓
25	✓	✓	✓	✓	100	✓	✓	✓	✓
30	✓	✓	✓	✓	110			✓	✓
35	✓	✓	✓	✓	120		✓	✓	✓
40	✓	✓	✓	✓	130		✓	✓	✓
45	✓	✓	✓	✓	140		✓	✓	✓
50	✓	✓	✓	✓	150		✓	✓	✓
60	✓	✓	✓	✓	160				✓
70	✓	✓	✓	✓	180				✓
80	✓	✓	✓	✓					



**Βύσματα ντίζας ανοξείδωτα**

INOX A2

TAP



Κωδικός	Τύπος
75204006000	8X25 M6
75204008000	10X30 M8
75204010000	12X40 M10
75204012000	15X50 M12

FRIULSIDER

Βύσματα ξύλου βιδωτά

INOX A2

WS9280



Κωδικός	Τύπος
S9280-2-4	M4
S9280-2-5	M5
S9280-2-6	M6
S9280-2-8	M8
S9280-2-10	M10

Βύσματα ξύλου καρφωτά

INOX A2

WS9312



Κωδικός	Τύπος
S9312-2-5	M5
S9312-2-6	M6
S9312-2-8	M8
S9312-2-10	M10

Βύσματα χτυπητά INOX A4

FM753 inox DIN9362



Κωδικός	Τύπος	Κωδικός	Τύπος
75320006065	M6X65mm	75320010120	M10X120mm
75320006085	M6X85mm	75320012080	M12X80mm
75320008075	M8X75mm	75320012110	M12X110mm
75320008090	M8X90mm	75320012135	M12X135mm
75320008115	M8X115mm	75320012160	M12X160mm
75320010075	M10X75mm		
75320010090	M10X90mm		

FRIULSIDER

Βύσματα χτυπητά INOX A2

DIN9362



Τύπος	Τύπος
8X75 (A4)	12X185
8X90	14X110
8X115	14X160
10X75	14X185
10X90	16X125
10X120	16X145
10X140	16X180
10X170	20X160
12X80	20X180
12X110	20X220
12X135	
12X160	

Αλενόβιδες σε μετρικό DIN912 INOX A2

Πάχος→	3	4	5	6	8	10	12	14	16
↓Μήκος↓									
3-6	✓	✓							
8	✓	✓	✓						
10	✓	✓	✓	✓	✓				
12	✓	✓	✓	✓	✓				
16	✓	✓	✓	✓	✓	✓			
20	✓	✓	✓	✓	✓	✓	✓		
25	✓	✓	✓	✓	✓	✓	✓	✓	✓
30	✓	✓	✓	✓	✓	✓	✓	✓	✓
35	✓	✓	✓	✓	✓	✓	✓	✓	✓
40	✓	✓	✓	✓	✓	✓	✓	✓	✓
45			✓	✓	✓	✓	✓	✓	✓
50		✓	✓	✓	✓	✓	✓	✓	✓
60			✓	✓	✓	✓	✓	✓	✓
70				✓	✓	✓	✓	✓	✓
80				✓	✓	✓	✓	✓	✓
90				✓	✓	✓	✓	✓	✓
100				✓	✓	✓	✓	✓	✓
110					✓	✓	✓		
120				✓	✓	✓	✓		
130					✓	✓	✓		
140					✓	✓	✓		
150					✓	✓	✓		



Αλενόβιδες ακέφαλες DIN916 INOX A2

Πάχος→	3	4	5	6	8	10	12
↓Μήκος↓							
3	✓						
4	✓	✓					
5	✓	✓	✓				
6	✓	✓	✓	✓			
8	✓	✓	✓	✓	✓		
10	✓	✓	✓	✓	✓	✓	
12	✓	✓	✓	✓	✓	✓	✓
16	✓	✓	✓	✓	✓	✓	✓
20		✓	✓	✓	✓	✓	✓
25		✓	✓	✓	✓	✓	✓
30				✓	✓	✓	✓
35					✓	✓	✓
40				✓	✓	✓	✓
50					✓	✓	



Αλενόβιδες φρεζάτες DIN7991 INOX A2

Πάχος→	4	5	6	8	10	12
↓Μήκος↓						
10	✓	✓	✓			
12	✓	✓	✓			
16	✓	✓	✓	✓		
20	✓	✓	✓	✓	✓	✓
25	✓	✓	✓	✓	✓	✓
30	✓	✓	✓	✓	✓	✓
35	✓	✓	✓	✓	✓	✓
40	✓	✓	✓	✓	✓	✓
45		✓	✓	✓	✓	✓
50		✓	✓	✓	✓	✓
60			✓	✓	✓	✓
70				✓	✓	✓
80				✓	✓	✓
90					✓	✓
100					✓	✓





Αλενόβιδες πομπέ DIN7380

INOX A2



Πάχος→	4	5	6	8	10
↓Μήκος↓					
10	✓	✓			
12	✓	✓	✓		
16	✓	✓	✓	✓	
20	✓	✓	✓	✓	✓
25	✓	✓	✓	✓	✓
30	✓	✓	✓	✓	✓
35		✓	✓	✓	✓
40		✓	✓	✓	✓
50			✓	✓	✓
60					

Αλενόβιδες ίντζας DIN912

INOX A2



Πάχος→	1/4"	5/16"	3/8"
↓Μήκος↓			
12			
16	✓	✓	
20	✓	✓	✓
25	✓	✓	✓
30	✓	✓	✓
35	✓		
40		✓	✓
45		✓	✓
50			✓

Αλενόβιδες με κοντό κεφάλι

DIN6912 INOX A2



Πάχος→	6	8	10
↓Μήκος↓			
10	✓	✓	
12	✓	✓	
16	✓	✓	✓
20	✓	✓	✓
25	✓	✓	✓
30	✓	✓	✓

Νοβοπανόβιδες WS9100

INOX A2



Πάχος→	3	3,5	4	5	6
↓Μήκος↓					
13	✓	✓			
16	✓	✓	✓		
20	✓	✓	✓	✓	
25	✓	✓	✓	✓	
30	✓	✓	✓	✓	✓
35			✓	✓	✓
40			✓	✓	✓
45			✓	✓	✓
50			✓	✓	✓
60			✓	✓	✓
70				✓	✓
80				✓	✓
90				✓	✓
100				✓	✓
120					✓

Νοβοπανόβιδες WS9130

INOX A2



Πάχος→	3	3,5	4	5	6
↓Μήκος↓					
16	✓				
20	✓	✓	✓	✓	
25		✓	✓	✓	
30	✓	✓	✓	✓	✓
35			✓	✓	
40			✓	✓	✓
50			✓	✓	✓
60			✓	✓	✓
70					✓
80					✓
100					✓

**Στριφώνια DIN571** INOX A2

Πάχος→	6	8	10	12
↓Μήκος↓				
30	✓	✓		
35	✓			
40	✓	✓	✓	
45	✓			
50	✓	✓	✓	✓
60	✓	✓	✓	✓
70	✓	✓	✓	✓
80	✓	✓	✓	✓
90	✓	✓	✓	✓
100	✓	✓	✓	✓
110	✓	✓	✓	✓
120	✓	✓	✓	✓
130		✓	✓	✓
140		✓	✓	✓
150		✓	✓	✓
160		✓	✓	✓
180		✓	✓	✓
200		✓	✓	✓

Στριφονόβιδες WS9210 INOX A2

Πάχος→	8	10
↓Μήκος↓		
70		
80	✓	✓
90	✓	✓
100	✓	✓
120	✓	✓
140	✓	✓

**Στριφονόβιδες WS9211** INOX A2**Περιγραφή**

M10x180mm

M10x250mm

M10x300mm χωρίς εξάγωνο

M12x300mm

M12x350mm

Ξυλόβιδες ψωμάκι torx INOX A2**Περιγραφή**

4,8x32mm T20

4,8x38mm T20

4,8x50mm T20

4,8x60mm T20

**Λαμαρινόβιδες τραπεζοειδείς DIN7981** INOX A2

Πάχος→	(3) 2,2	(4) 2,9	(6) 3,5	(8) 4,2	(10) 4,8	(12) 5,5	(14) 6,3
↓Μήκος↓							
6,5 (¼")	✓	✓	✓				
9,5 (⅜")	✓	✓	✓	✓			
13 (½")		✓	✓	✓	✓	✓	
16 (⅝")		✓	✓	✓	✓	✓	✓
19 (¾")		✓	✓	✓	✓	✓	✓
25 (1")		✓	✓	✓	✓	✓	✓
32 (1¼")		✓	✓	✓	✓	✓	✓
38 (1½")				✓	✓	✓	✓
45 (1¾")							✓
50 (2")				✓	✓	✓	✓
60 (2½")				✓	✓	✓	✓





Λαμαρινόβιδες φρεζάτες DIN7982 INOX A2



Πάχος→	(3) 2,2	(4) 2,9	(6) 3,5	(8) 4,2	(10) 4,8	(12) 5,5	(14) 6,3
↓Μήκος↓							
6,5 (¼")	✓	✓	✓				
9,5 (⅜")	✓	✓	✓	✓			
13 (½")		✓	✓	✓	✓	✓	
16 (⅝")		✓	✓	✓	✓	✓	✓
19 (¾")		✓	✓	✓	✓	✓	✓
25 (1")		✓	✓	✓	✓	✓	✓
32 (1¼")		✓	✓	✓	✓	✓	✓
38 (1½")				✓	✓	✓	✓
45 (1¾")							✓
50 (2")				✓	✓	✓	✓
60 (2½")				✓	✓	✓	✓



Λαμαρινόβιδες WS9200

INOX A2



Πάχος→	4,8	5,5	6,3
↓Μήκος↓			
13	✓		
16	✓	✓	✓
19	✓	✓	✓
25	✓	✓	✓
32	✓	✓	✓
38	✓	✓	✓
50	✓	✓	✓
60		✓	✓
70			✓

Λαμαρινόβιδες εξάγωνες DIN7976

INOX A2



Πάχος→	6,3
↓Μήκος↓	
13	✓
16	✓
19	✓
25	✓
32	✓
38	✓
50	✓

Λαμαρινόβιδες φρεζάτες φακή DIN7983

INOX A2



Πάχος→	2,9	3,5	4,2	4,8	5,5	6,3
↓Μήκος↓						
6,5	✓					
9,5	✓		✓			
13	✓	✓	✓	✓		
16	✓	✓	✓	✓	✓	✓
19	✓	✓	✓	✓	✓	✓
25	✓	✓	✓	✓	✓	✓
32		✓	✓	✓	✓	✓
38		✓	✓	✓	✓	✓
50			✓	✓	✓	✓
60				✓	✓	✓

Τρυπανόβιδες φρεζάτες DIN7504P

INOX A2



Πάχος→	4,2	4,8
↓Μήκος↓		
13	✓	
16	✓	✓
19	✓	✓
25	✓	✓
32	✓	✓
38	✓	✓
50		✓

Τρυπανόβιδες πομπέ DIN7504N

INOX A2



Πάχος→	3,5	4,2	4,8
↓Μήκος↓			
13	✓	✓	
16	✓	✓	✓
19		✓	✓
22	✓		
25	✓	✓	✓
32		✓	✓
38		✓	✓

Τρυπανόβιδες εξάγωνες DIN7504K

INOX A2

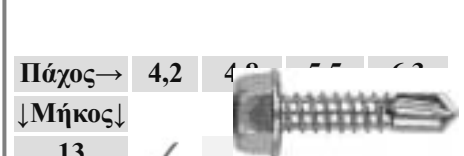

Πάχος→	4,2	4,8	5,5	6,3
↓Μήκος↓				
13	✓			
16	✓			
19	✓	✓	✓	✓
25	✓	✓	✓	✓
32	✓	✓	✓	✓
38		✓	✓	✓
45		✓	✓	
50		✓	✓	✓
70			✓	
80			✓	

Ασφάλειες άξονος DIN471 **INOX A2**

Τύπος	Τύπος	Τύπος	Τύπος	Τύπος
A5	A14	A24	A36	A65
A6	A15	A25	A38	A70
A7	A16	A26	A40	A75
A8	A17	A27	A42	A80
A9	A18	A28	A45	A100
A10	A19	A29	A48	
A11	A20	A30	A50	
A12	A22	A32	A55	
A13	A23	A35	A60	

Ασφάλειες τρύπας DIN472 **INOX A2**

Τύπος	Τύπος	Τύπος	Τύπος	Τύπος
B8	B19	B32	B48	B75
B9	B20	B34	B50	B80
B10		B35	B52	B90
B11	B22	B36	B55	B95
B12	B24	B37	B60	B100
B13	B25	B38	B62	
B14	B26	B40	B65	
B16	B27	B42	B68	
B17	B28	B45	B70	
B18	B30	B47	B72	

Κοπίλιες DIN94 **INOX A2**

Τύπος	Τύπος	Τύπος	Τύπος	Τύπος
1,6X20	2X50	3,2X36	4X45	5X100
1,6X25	2,5X20	3,2X40	4X50	6,3X40
1,6X32	2,5X25	3,2X45	4X63	6,3X45
1,6X40	2,5X32	3,2X50	4X80	6,3X50
2X20	2,5X36	3,2X63	5X32	6,3X63
2X25	2,5X40	4X20	5X36	6,3X100
2X32	2,5X50	4X25	5X50	
2X36	3,2X20	4X32	5X63	
2X40	3,2X25	4X36	5X71	
2X45	3,2X32	4X40	5X80	

Σφήνες DIN6885 **INOX A2**

Τύπος	Τύπος	Τύπος
5X5X16	6X6X45	8X7X60
5X5X20	6X6X50	10X8X30
5X5X25	6X6X60	10X8X40
5X5X30	8X7X20	10X8X50
6X6X16	8X7X25	10X8X60
6X6X20	8X7X30	12X8X40
6X6X25	8X7X36	12X8X50
6X6X30	8X7X40	12X8X60
6X6X35	8X7X45	12X8X70
6X6X40	8X7X50	

Σφήνες μέτρου DIN6885 **INOX A2**

Τύπος
5X5X1000
6X6X1000
8X7X1000
10X8X1000
12X8X1000
14X9X1000
16X10X1000
*το τεμάχιο



**Ασφάλειες μισοφέγγαρες DIN6799** INOX A2

Τύπος	Τύπος
Z1,9	Z8
Z3	Z9
Z4	Z10
Z5	Z12
Z6	Z15
Z7	

**Μποζόνια DIN939** INOX A2

Τύπος
6X30
6X40
8X30
8X40
8X50
10X30
10X50

**Καβίλιες DIN1481** INOX A2

Τύπος	Τύπος	Τύπος	Τύπος
2X10	4X16	5X36	8X30
2X16	4X20	5X40	8X40
2X20	4X24	5X50	8X50
2,5X10	4X30	6X20	8X60
2,5X16	4X36	6X24	10X50
2,5X20	4X40	6X30	10X60
3X16	5X16	6X36	
3X20	5X20	6X40	
3X24	5X24	6X50	
3X30	5X30	6X60	

**Περόνες M8377** INOX A4

D	L	D1	A	H
2,0mm	47mm	12mm	13mm	3mm
2,5mm	64mm	16mm	23mm	5mm
3,0mm	68mm	20mm	24mm	6mm
4,0mm	84mm	22mm	27mm	7mm
5,0mm	97mm	24mm	35mm	7mm
6,0mm	108mm	24mm	39mm	7mm

Περόνες M8378 INOX A4

D	L	D1
2,5mm	42mm	20mm
3,2mm	48mm	20mm
4,0mm	64mm	20mm
5,0mm	80mm	25mm
6,3mm	97mm	25mm
7,0mm	125mm	30mm
8,0mm	150mm	30mm

Πίροι εντατήρα M8144 INOX A4

D	L	N	D	L	N
B 4mm	19mm	16mm	N 8mm	21mm	17mm
C 5mm	15mm	11mm	O 8mm	24mm	20mm
D 5mm	18mm	14mm	P 8mm	27mm	23mm
E 5mm	21mm	17mm	Q 8mm	32mm	28mm
F 6mm	15mm	11mm	R 9,5mm	26mm	22mm
G 6mm	20mm	16mm	S 9,5mm	30mm	26mm
H 6mm	25mm	21mm	T 10mm	30mm	26mm
I 6mm	29mm	25mm	U 11mm	30mm	25mm
J 6mm	36mm	32mm	V 12mm	30mm	26mm
K 6mm	45mm	41mm	W 15mm	41mm	36mm

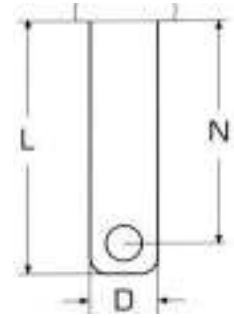
**Πίροι εντατήρα ασφαλείας M8356 INOX A4**

D	L1	L2
6mm	65mm	60mm
8mm	28mm	20mm
10mm	35mm	25mm

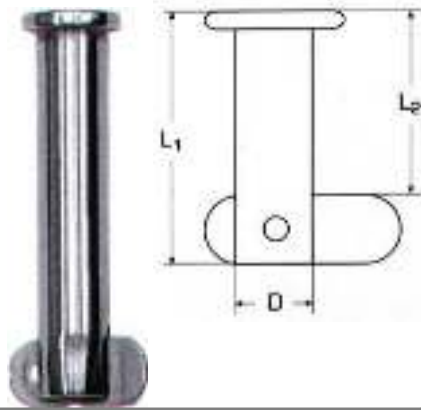
**Πίροι εντατήρα με μπίλια και κρίκο M8374 INOX A4**

D	L1	L2
5mm	25mm	17mm
6mm	25mm	17mm
8mm	25mm	17mm
8mm	38mm	26mm

**Ασφάλειες πύρου M8383 INOX A4**

D1	D2
1mm	11mm
1,25mm	15mm
1,5mm	19mm
2mm	23mm

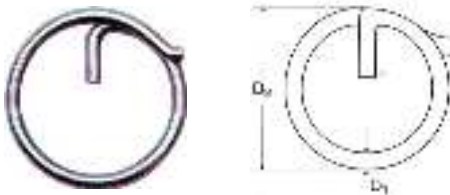
**Ασφάλειες εντατήρα M8155 INOX A4**

D	D1
1,5mm	18mm
1,5mm	22mm
1,5mm	26mm
1,5mm	30mm

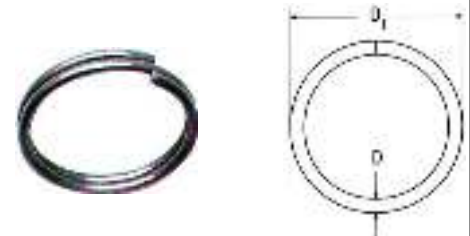
**Γάντζοι "S" M8160 INOX A4**

D	L	W	S
3mm	24mm	9mm	4mm
4mm	32mm	12mm	6mm
5mm	40mm	15mm	7mm
6mm	48mm	17mm	8mm
8mm	64mm	24mm	12mm

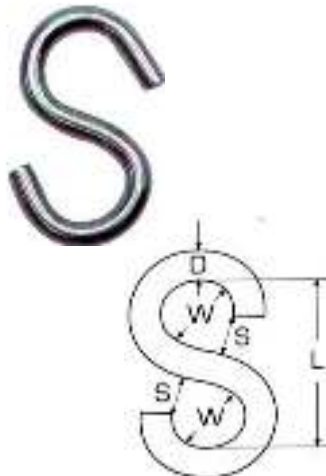
**Δέλτα M8376 INOX A4**

D	L	W
3mm	15mm	12mm
3mm	20mm	12mm
4mm	20mm	17mm
4mm	25mm	22mm
4mm	30mm	27mm
5mm	25mm	22mm
5mm	30mm	27mm
6mm	30mm	27mm
6mm	40mm	37mm
6mm	50mm	47mm
8mm	50mm	47mm

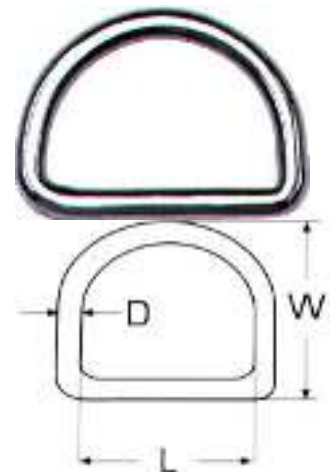

**Κρίκοι M8229** INOX A4

D	W	D	W
3mm	20mm	6mm	60mm
3mm	30mm	6mm	80mm
4mm	25mm	8mm	40mm
4mm	30mm	8mm	50mm
4mm	35mm	8mm	80mm
4mm	40mm	8mm	100mm
5mm	30mm	10mm	50mm
5mm	40mm	10mm	60mm
5mm	50mm	10mm	70mm
6mm	35mm	10mm	80mm
6mm	40mm	10mm	100mm
6mm	45mm		

**Περτσίνια με πάσο** INOX A2

Πάσο	Διάμετρος	Κεφάλι	Μήκος
M4	5,9mm	9mm	11,5mm
M5	6,8mm	12,3mm	13,3mm
M6	8,9mm	12mm	16mm
M8	10,9mm	15mm	18,5mm
M10	12,8mm	17mm	18,9mm

Περτσίνια φρεζάτα DIN661 INOX A2

Πάχος→	3	4	5	6
6	✓			
8	✓	✓		
10	✓	✓	✓	
12	✓	✓	✓	✓
16	✓	✓	✓	✓
20	✓	✓		
25		✓	✓	✓
30		✓		✓

**Περτσίνια στρογγυλοκέφαλα DIN660** INOX A2

Πάχος→	3	4	5	6
6		✓	✓	
8	✓	✓	✓	
10	✓	✓	✓	
12	✓	✓	✓	
16	✓	✓		✓
20	✓	✓	✓	✓
25			✓	✓
30		✓		✓

**Πρεσαριστή τάπα M8558** INOX A4

Τύπος
3X18
4X24
5X28
6X32

Περτσίνια INOX A2

Πάχος→	3,0	4,0	4,8
6	✓	✓	
8	✓	✓	
10	✓	✓	✓
12	✓	✓	✓
14	✓	✓	
16	✓	✓	✓
20		✓	✓
25			✓
30			✓



**Μεντεσέδες σωλήνων M8136** INOX A4

L	D	H
70mm	20mm	25mm

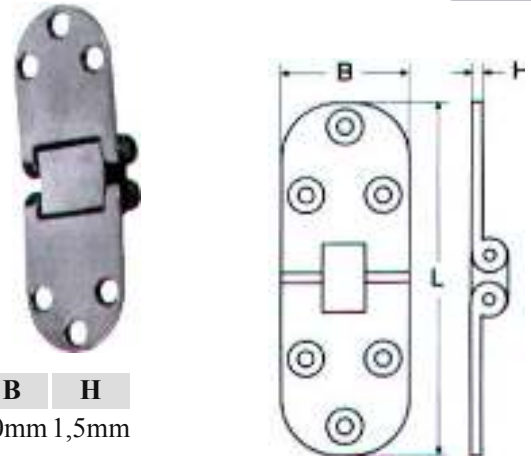
Μεντεσέδες με διπλό πύρο M8018 INOX A4

L	B	H
80mm	30mm	1,5mm

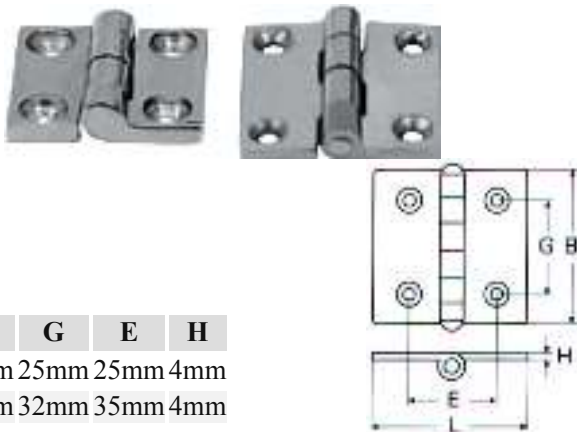
Μεντεσέδες χυτοί M8233 INOX A4

L	B	G	E	H
38mm	38mm	25mm	25mm	4mm
50mm	50mm	32mm	35mm	4mm

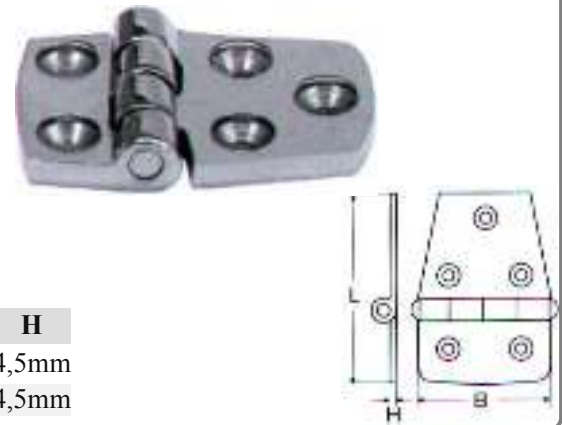
Μεντεσέδες χυτοί M8234 INOX A4

L	B	H
57mm	38mm	4,5mm
76mm	38mm	4,5mm

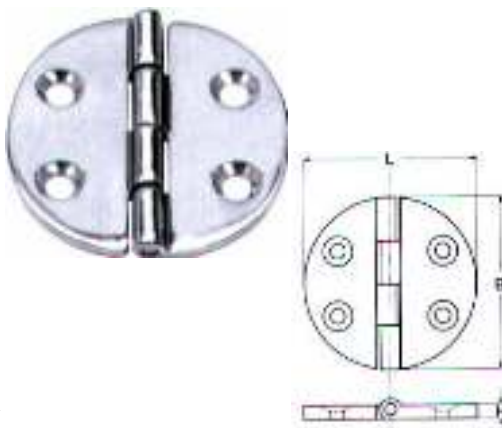
Μεντεσέδες χυτοί στρόγγυλοι M8428 INOX A4

L	B	H
64mm	64mm	4mm

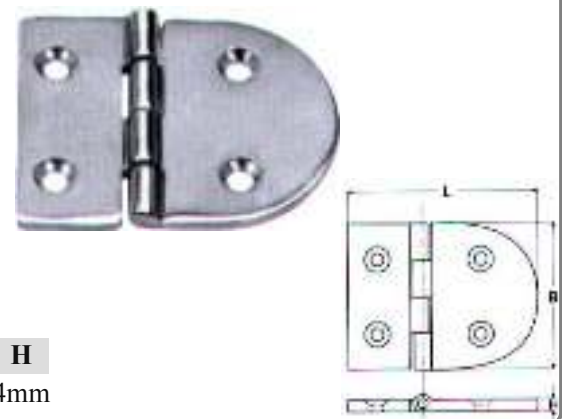
Μεντεσέδες M8429 INOX A4

L	B	H
81mm	64mm	4mm

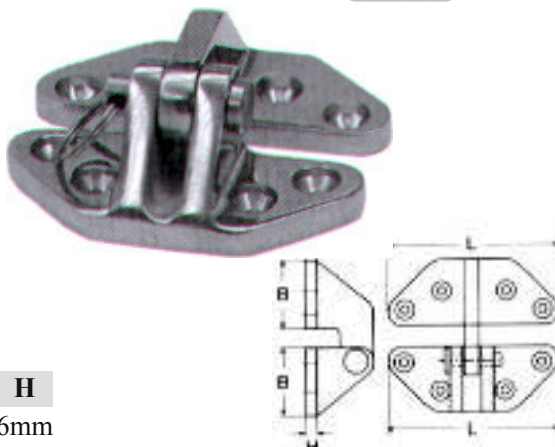
Μεντεσέδες με πύρο M8238 INOX A4

L	B	H
71mm	28mm	6mm

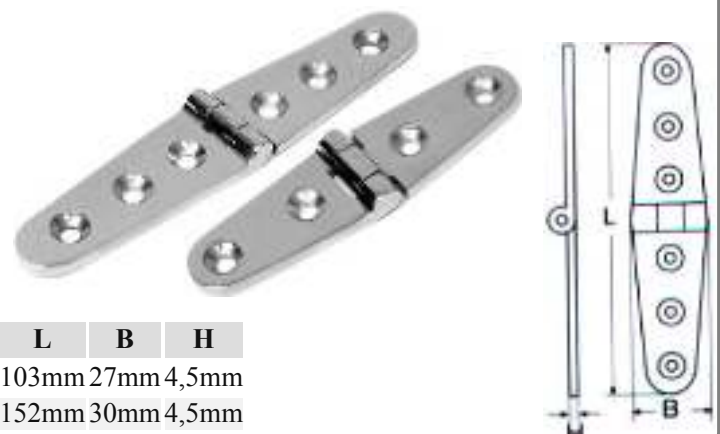
Μεντεσέδες μακρόστενοι M8235 INOX A4

L	B	H
103mm	27mm	4,5mm
152mm	30mm	4,5mm

Μεντεσέδες με γόνατο M8237 INOX A4

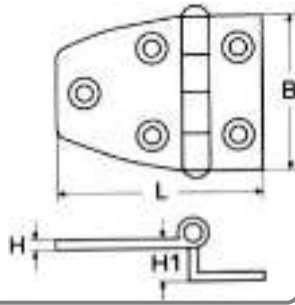

L	B	H	H1
54mm	37mm	4,5mm	14mm
70mm	37mm	4,5mm	14mm

Μεντεσέδες χυτοί διαρούμενοι M8239 INOX A4

*η φωτογραφία δείχνει δεξιό

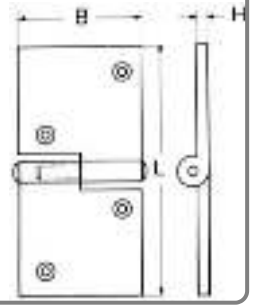
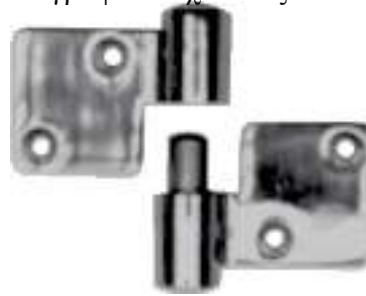

Τύπος	L	B	H
Αριστερός	92mm	36mm	5mm
Δεξιός	92mm	36mm	5mm

Μεντεσέδες χυτοί M8280 INOX A4

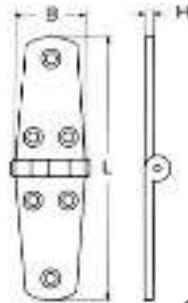

Τύπος	L	B	H
A	76mm	38mm	4,5mm
B	102mm	38mm	4,5mm

Μεντεσέδες χυτοί τύπου "T" M8281 INOX A4

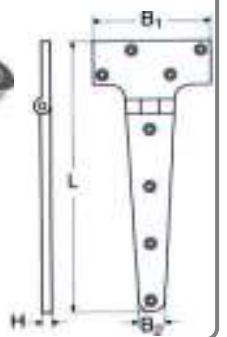

L	B1	B2	H
195mm	98mm	20mm	5mm

Μεντεσέδες οβάλ M8045 INOX A4

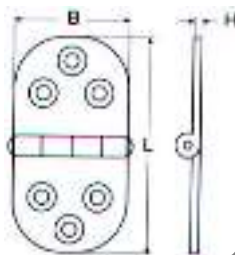

L	B	H
47mm	30mm	1,5mm
75mm	40mm	1,5mm
80mm	40mm	2,5mm

Μεντεσέδες μακρόστενοι M8046 INOX A4

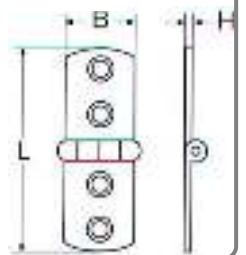

L	B	H
75mm	20mm	1,5mm
85mm	30mm	1,5mm
100mm	40mm	1,5mm

Μεντεσέδες μακρόστενοι M8047 INOX A4

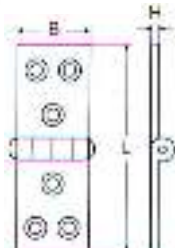

L	B	H
80mm	20mm	1,5mm
90mm	30mm	1,5mm
100mm	40mm	1,5mm

Μεντεσέδες M8043 INOX A4

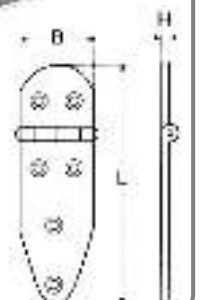

L	B	H
130mm	40mm	1,5mm

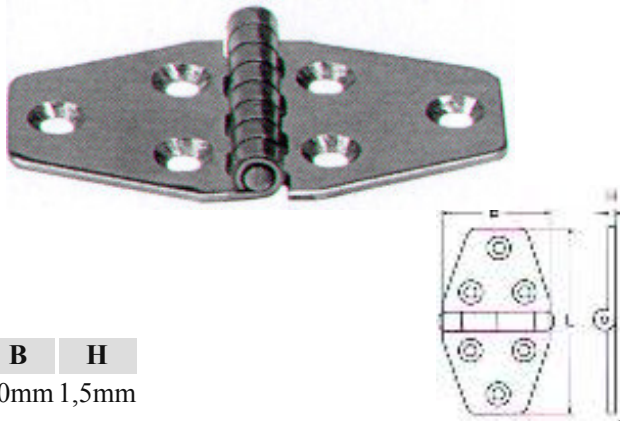
Μεντεσέδες M8044 INOX A4

L	B	H
70mm	40mm	1,5mm

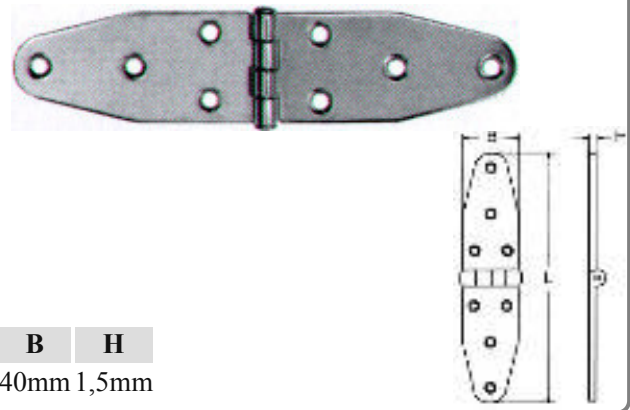
Μεντεσέδες M8048 INOX A4

L	B	H
185mm	40mm	1,5mm

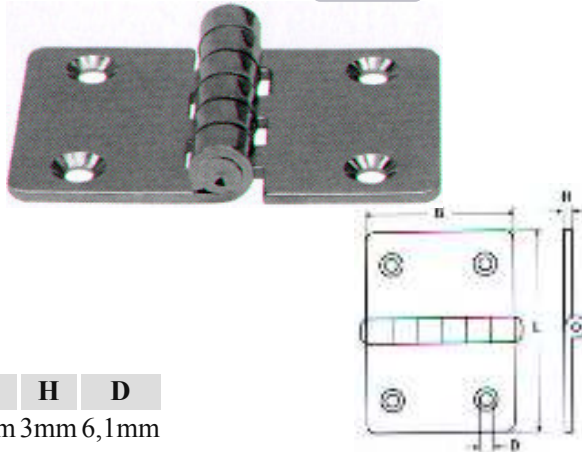
Μεντεσέδες M8151 INOX A4

L	B	H	D
90mm	60mm	3mm	6,1mm

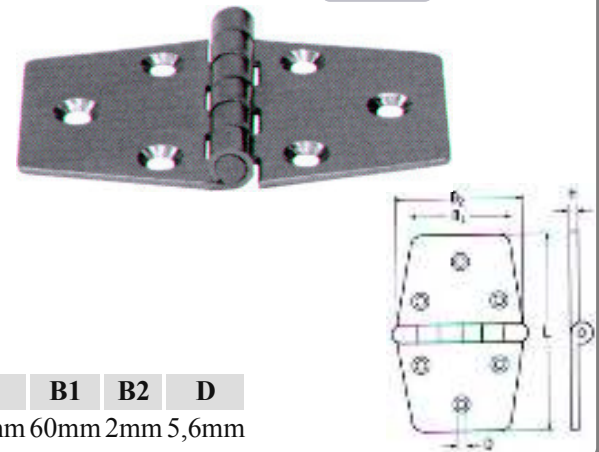
Μεντεσέδες M8152 INOX A4

L	B	B1	B2	D
95mm	38mm	60mm	2mm	5,6mm

Μεντεσέδες ART1228 INOX A4

No	A	B	C	R	Ø
6	60	15	27	2	12
8	80	15	37	2	12
10	100	18	46	2,2	14,5
12	120	21	55	2,2	14,5
14	140	21	65	2,5	16,5

**Μεντεσέδες ART1229** INOX A4

No	A	B	C	C1	R
14	140	21	32	65	2

**Μεντεσέδες δίμετροι** INOX A2**Τύπος**

25X0,7
30X0,7
38X0,7
38X1,2
50X0,7
50X1,2
50X2,0
60X1,2
60X2,0
70X2,0
70X3,0



Μεντεσέδες M8049 INOX A2

B	L	H	D
A 30	40	1,5	3,9
B 40	40	1,5	4,5
C 40	60	1,5	4,5
D 50	60	1,5	5,5
E 60	60	1,5	4,5
F 50	80	1,5	4,5
G 60	80	1,5	4,5
H 70	80	1,5	4,5
I 80	80	1,5	4,5
P 100	100	1,5	4,5

**Μεντεσέδες M8150** INOX A2

B	L	H	D
A 25	300	84,5	
B 28,5	300	84,5	
C 35	400	84,5	
D 40	400	84,5	
E 40	500	84,5	
F 50	500	84,5	
G 50	600	84,5	
H 55	700	84,5	

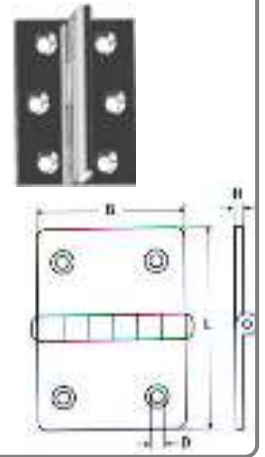
**Μεντεσέδες πλακέ AKSSSN20** INOX A4

Μήκος	Πλάτος	Πάχος
3"	3"	2mm
3½"	3½"	2mm
4"	3"	2mm
4"	3½"	2mm
4"	4"	2mm

**Μεντεσέδες με ρουλεμάν AKSSSB20** INOX A4

Μήκος	Πλάτος	Πάχος
3"	3"	2mm
3½"	3½"	2mm
4"	3"	2mm
4"	3½"	2mm
4"	4"	2mm
4½"	4"	3mm
4½"	4½"	3mm

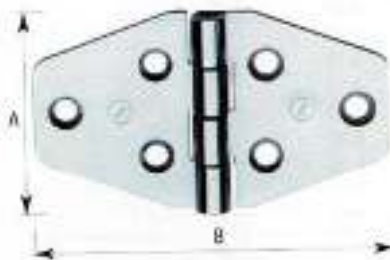
**Μεντεσέδες ρόμβου ART854** INOX A4

A	B
40mm	70mm

**Μεντεσέδες ρόμβου κοφτοί ART852** INOX A4

A	B
40mm	55mm

**Μεντεσέδες διαιρούμενοι αριστεροί** INOX 18/8

Κωδικός	A	B
7324	60mm	40mm
7326	70mm	50mm

**Μεντεσέδες διαιρούμενοι δεξιοί** INOX 18/8

Κωδικός	A	B
7323	60mm	40mm
7325	70mm	50mm





Μεντεσέδες αλέ ρετούρ **INOX 18/8**

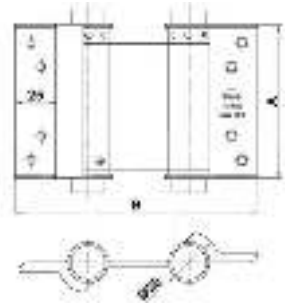

Κωδικός	A	B	Πλάτος πόρτας	Πάχος πόρτας	Βάρος πόρτας
7376	77mm	130mm	65mm	≤28mm	≤16kg



Καταβάτες γωνιακοί ART1140&ART1142

INOX A4

Δέχεται λουκέτο



A B
83mm 25mm

Μάνταλα πόρτας M8181

INOX A4

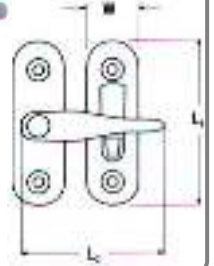

L1 W L2
63mm 19mm 40mm

Ζεμπερέκια πόρτας M8384

INOX A4

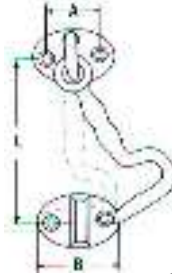

L A B
100mm 24mm 38mm

Ζεμπερέκια πόρτας M8708

INOX A4

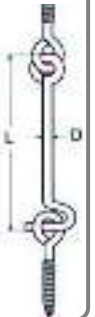

L D
80mm 4mm
100mm 4mm
120mm 4,5mm
140mm 5,2mm

Καταβάτες M8518

INOX A4

Δέχεται λουκέτο

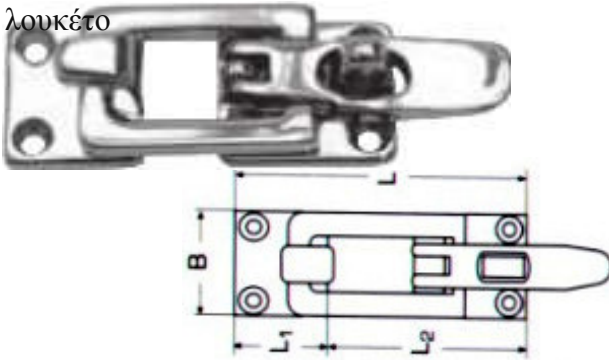

L B L1 L2
70mm 28mm 25mm 45mm

Καταβάτες M8053A

INOX A4

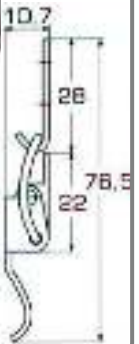

Δύναμη
0,5kN

Καταβάτες γωνιακοί M8519

INOX A4

Δέχεται λουκέτο

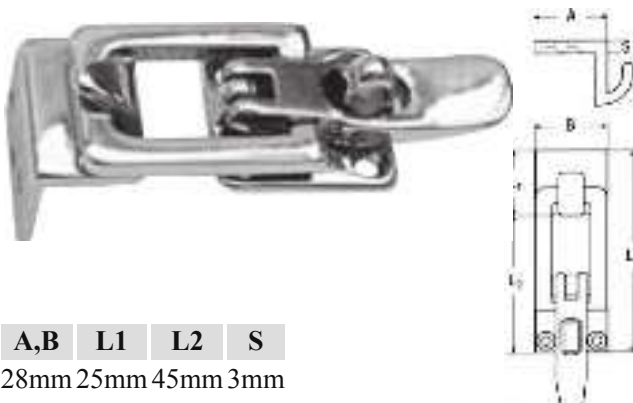

L A,B L1 L2 S
70mm 28mm 25mm 45mm 3mm

Καταβάτες M8053B

INOX A4

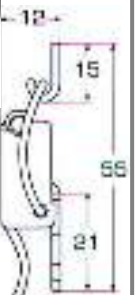

Δύναμη
0,5kN

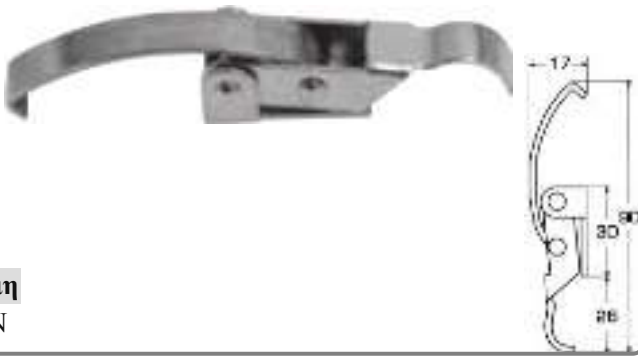
Καταβάτες M8053C INOX A4

Δύναμη
0,5kN

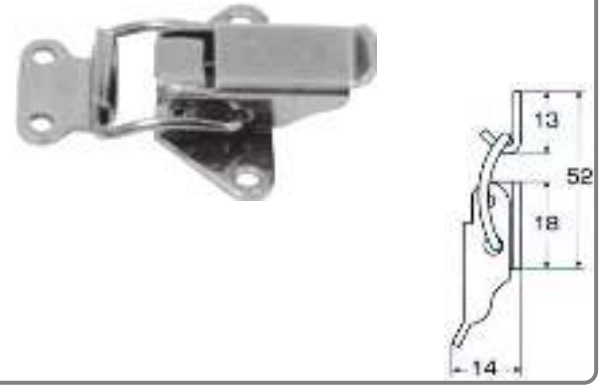
Καταβάτες M8053D INOX A4

Δύναμη
0,55kN

Καταβάτες M8053F INOX A4

Δύναμη
0,2kN

Καταβάτες M8053G INOX A4

Δύναμη
1kN

Καταβάτες M8053H INOX A4

Δύναμη
2kN

Καταβάτες M8053O INOX A4

Δέχεται λουκέτο



Δύναμη
0,55kN

Καταβάτες M8053P INOX A4

Δέχεται λουκέτο



Δύναμη
1kN

Καταβάτες M8053Q INOX A4

Δέχεται λουκέτο



Δύναμη
0,2kN



Καταβάτες M8053I INOX A4



Δύναμη
1kN

Καταβάτες M8053L INOX A4



Δύναμη
1,5kN

Καταβάτες M8053M INOX A4

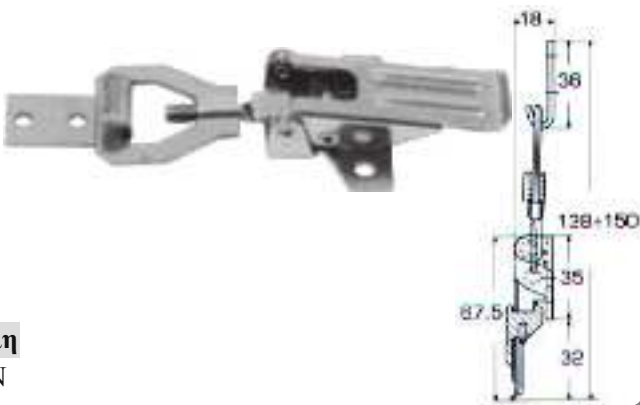

Δύναμη
1,1kN

Καταβάτες M8053N INOX A4

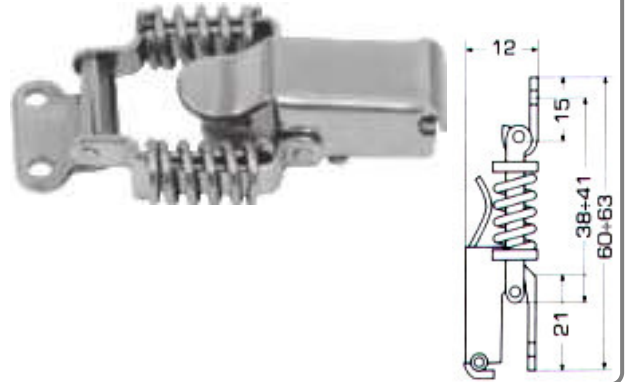

Δύναμη
1,1kN

Καταβάτες κυψελών 73X25mm INOX A2

Δέχεται λουκέτο



Κωδικός
DL032

Καταβάτες κυψελών 5mm INOX A2

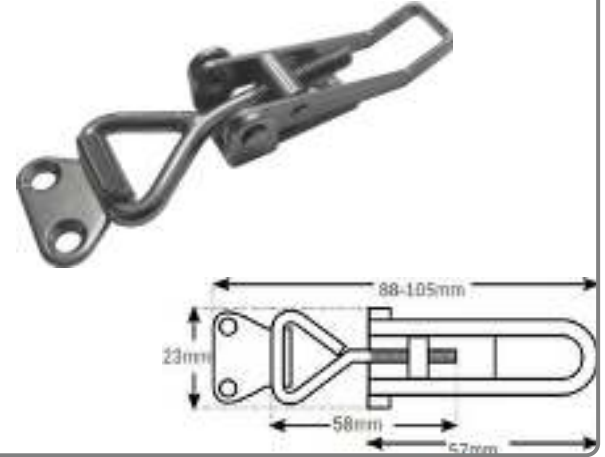

Κωδικός
DL001

Καταβάτες κυψελών 6mm INOX A2

Δέχεται λουκέτο

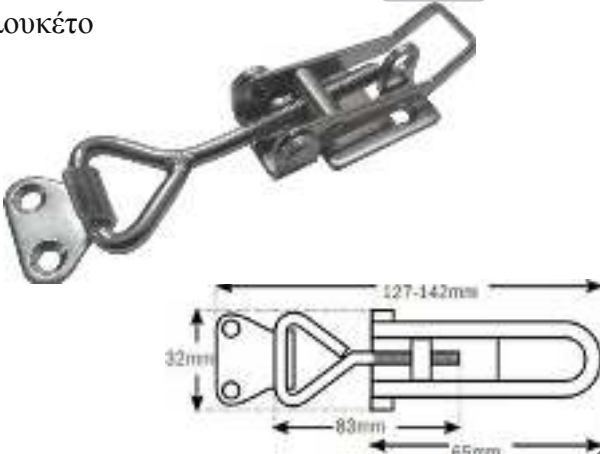

Κωδικός
DL004

Καταβάτες κυψελών 8mm INOX A2

Δέχεται λουκέτο

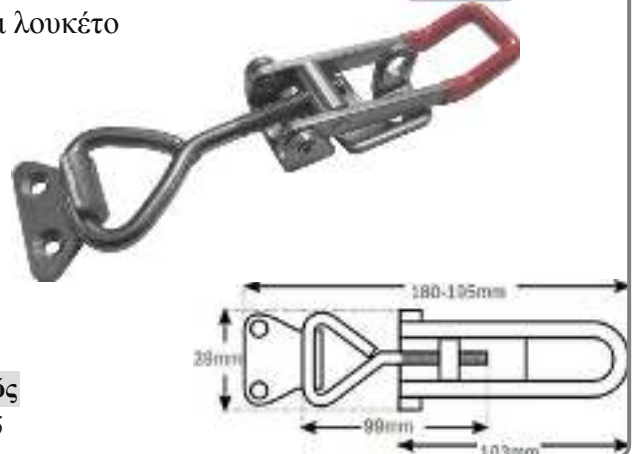

Κωδικός
DL005

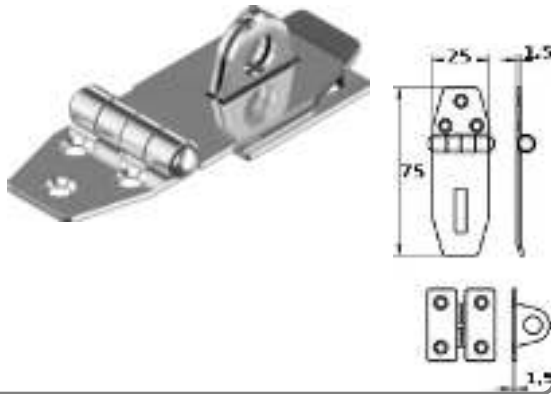
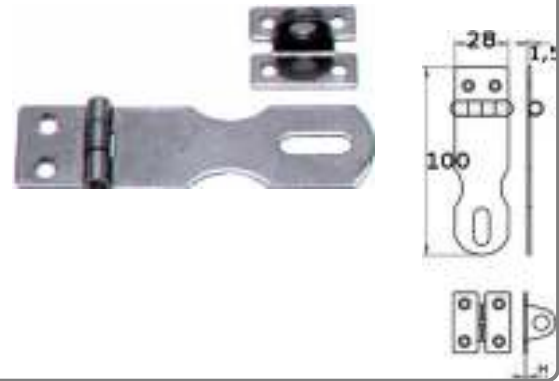
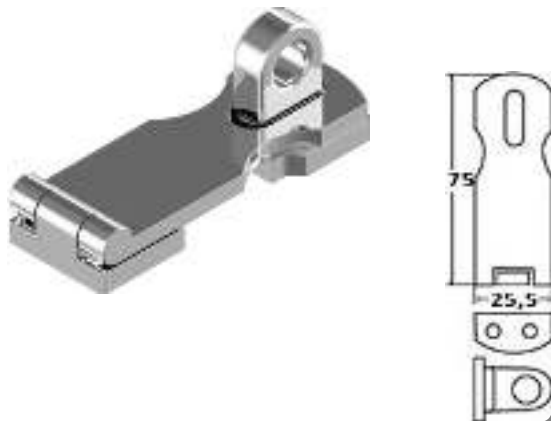
Καταβάτες πλακέ M8052A INOX A4**Καταβάτες πλακέ M8052** INOX A4**Καταβάτες M8050** INOX A4**Σύρτες πλακέ** INOX A4

Κωδικός	Μήκος
AKCH482-611150	50mm
AKCH482-611165	65mm

**Σύρτες με στρόγγυλο πύρο** INOX A4

Κωδικός	Μήκος
AKA350-1	90mm
AKA350-1	150mm

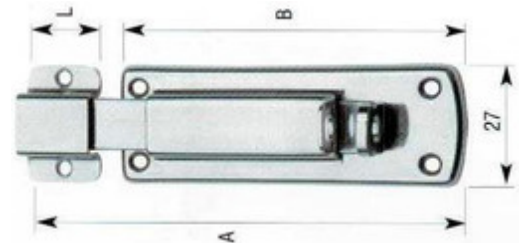
**Σύρτες πλακέ** INOX A4

Κωδικός	A	B	L
ART214-8	85mm	67mm	18mm
ART214-10	100mm	82mm	18mm

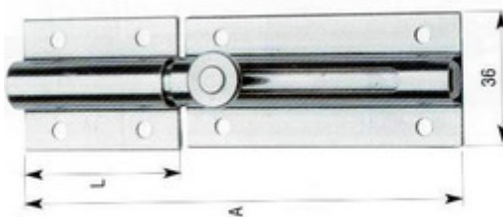
Σύρτες με στρόγγυλο πύρο INOX A4

Κωδικός	A	L
ART216-8	80,5mm	30mm
ART216-12	120,5mm	45mm

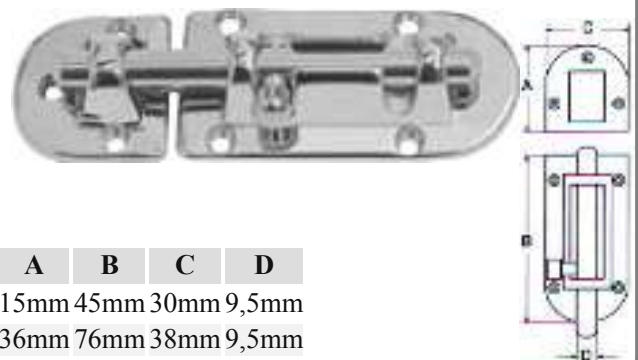
Σύρτες με στρόγγυλο πύρο M8333 INOX A4

Τύπος	A	B	C	D
A	15mm	45mm	30mm	9,5mm
B	36mm	76mm	38mm	9,5mm



Δέχεται λουκέτο

Σύρτες πόρτας INOX 18/8

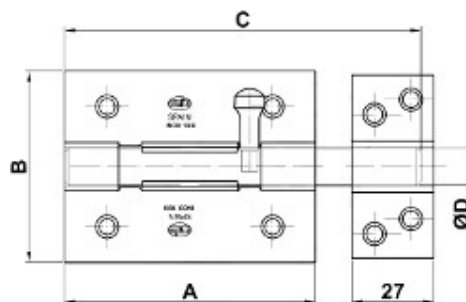

Κωδικός	A	B	L	C	Οπές
14176	70mm	67mm	104mm	13mm	4
14177	85mm	67mm	126mm	13mm	4
14178	100mm	67mm	146mm	13mm	6
14179	120mm	67mm	184mm	15mm	6



Σύρτες πόρτας INOX 18/8



Κωδικός	A	B	C	D	E	F	H
17942	25mm	16mm	20mm	6,5mm	12mm	0,8mm	14mm
7445	30mm	21mm	20mm	6,5mm	12mm	0,8mm	19mm
6517	40mm	28mm	27mm	9mm	14mm	1,2mm	26mm
6518	50mm	38mm	27mm	9mm	14mm	1,2mm	26mm
6519	65mm	53mm	27mm	9mm	14mm	1,2mm	26mm
6520	80mm	68mm	27mm	9mm	14mm	1,2mm	26mm
8068	100mm	88mm	27mm	9mm	14mm	1,2mm	36mm

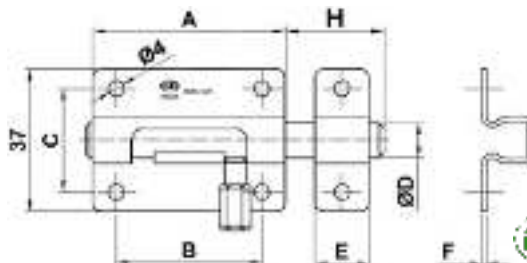

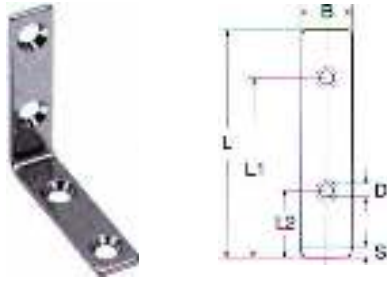
Γωνίες παραλληλόγραμμα M8340 INOX A4

L	L1	L2	B	S	D
A 31mm	25mm	12mm	12mm	3mm	4mm
B 46mm	38mm	18mm	13mm	3mm	4mm
C 61mm	51mm	21mm	15mm	3mm	4mm

Γωνίες τραπεζοειδείς M8341 INOX A4

L	L1	L2	B	S	D
A 41mm	35mm	18mm	28mm	3mm	5mm
B 56mm	47,5mm	18,5mm	35mm	3mm	5mm
C 80mm	71mm	24mm	50mm	4mm	5mm

Γωνίες πλακέ ART153 INOX A2

A	B
40mm	40mm
50mm	50mm
60mm	60mm
70mm	70mm

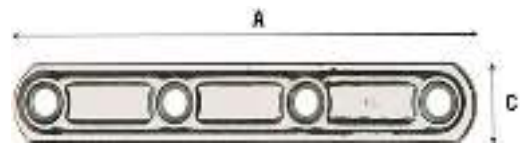
Γωνίες πλακέ ART163 INOX A2

A	B
61mm	15mm
79mm	15mm
99mm	15mm
119mm	15mm
139mm	15mm

Γωνίες ART164 INOX A2

A	B
31mm	31mm
40mm	40mm
50mm	50mm
60mm	60mm
70mm	70mm

Λάμες πλακέ ενισχυμένες ART778 INOX A2

Πάχος: 2,5mm

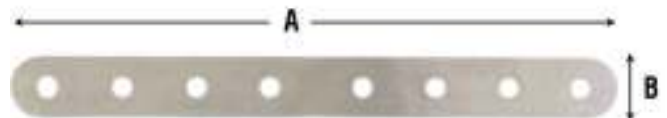

A	B
100mm	20mm
206mm	20mm

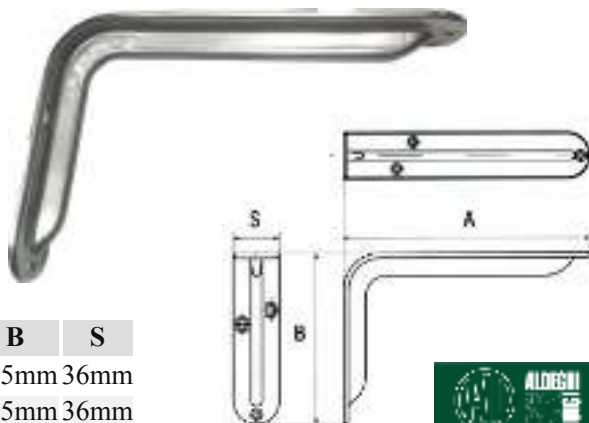
Γωνίες ραφιών με νεύρο ART2522 INOX A2

A	B	S
195mm	135mm	36mm
245mm	165mm	36mm

Χειρολαβές Ø19 INOX 18/8

Κωδικός	Μήκος
6170	150mm
6171	200mm
6172	250mm
6173	300mm

Στηρίγματα τζαμιών κούρμπα

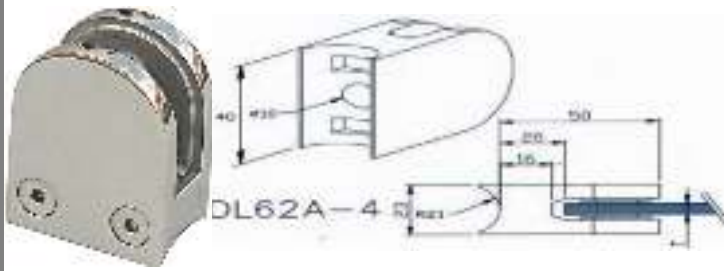

Κωδικός **Τύπος**
DL62A-4 Γυαλιστερό INOX 316



Στηρίγματα τζαμιών ίσια

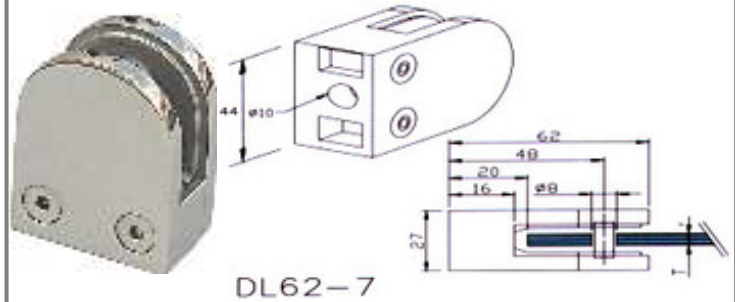

Κωδικός **Τύπος**
DL62-7 Σατινέ INOX 304
DL62-7 Γυαλιστερό INOX 316



Στηρίγματα τζαμιών κούρμπα

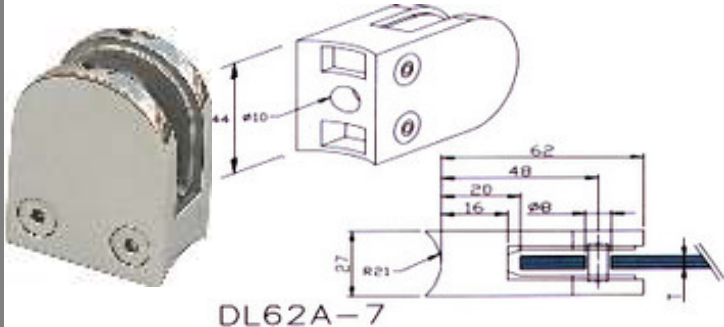

Κωδικός **Τύπος**
DL62A-7 Σατινέ INOX 304
DL62A-7 Γυαλιστερό INOX 316



Στοπ πόρτας πατητό INOX A4



Κωδικός **Τύπος**
AKA350-SB01 140mm



Στοπ πόρτας επιτοίχιο INOX A4



Κωδικός **Τύπος**
AKA350-MP70 3/4"



Στοπ πόρτας με λάστιχο INOX A4

Περιλαμβάνει βύσμα μετετού



Κωδικός **Κορμός** **Μήκος** **Διάμετρος**
AKA384-9 29mm 40mm 35mm



Στοπ πόρτας με φαρδύ λάστιχο INOX A4

Περιλαμβάνει βύσμα μετετού



Κωδικός **Κορμός** **Μήκος** **Διάμετρος**
AKA384-10 29mm 40mm 45mm



Ναυτικά κλειδιά "D" λάμας M8293 INOX A4

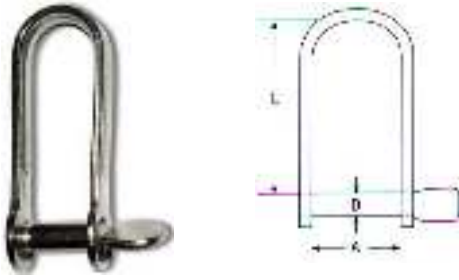

D	A	L
4mm	10mm	15mm
5mm	12mm	18mm
6mm	15mm	25mm

Σύνδεσμοι αλυσίδας M8308 INOX A4



D	B	L
6mm	9mm	17,5mm
8mm	13mm	21mm
10mm	13mm	24mm

Ναυτικά κλειδιά "D" με βίδα άλλεν M8261 INOX A4



D	A	L
6mm	12mm	21mm
8mm	16mm	28mm
10mm	20mm	35mm
12mm	24mm	42mm

Ναυτικά κλειδιά "D" φαρδιά M8269 INOX A4

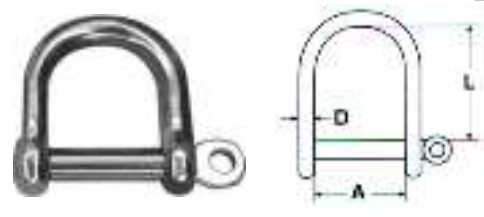

D	B	L
5mm	25mm	20mm
6mm	24mm	33mm
8mm	28mm	32mm
10mm	40mm	55mm

Σύνδεσμοι αλυσίδας M8253 INOX A4



D	L	B	X	S
4mm	32mm	12mm	5,5mm	5,5mm
5mm	39mm	13mm	6mm	6,5mm
6mm	45mm	14mm	7,5mm	7,5mm
8mm	58mm	17mm	11mm	10mm
10mm	69mm	21mm	12mm	12mm
12mm	81mm	24mm	16mm	14,5mm

Ναυτικά κλειδιά "D" M8358 INOX A4



D	A	L	BL
4mm	8mm	14mm	6kN
5mm	10mm	17mm	8kN
6mm	12mm	21mm	12kN
8mm	16mm	28mm	28kN
10mm	20mm	35mm	40kN
12mm	24mm	42mm	48kN

Ναυτικά κλειδιά "D" M8258 INOX A4

D	A	L	BL
3mm	8mm	12mm	4kN
4mm	8mm	14mm	6,8kN
5mm	10mm	17mm	9,8kN
6mm	12mm	21mm	14,7kN
7mm	14mm	24mm	25kN
8mm	16mm	28mm	29,4kN
10mm	20mm	35mm	44,1kN
12mm	24mm	42mm	68,6kN
14mm	28mm	45mm	90kN
16mm	32mm	55mm	98kN
19mm	38mm	66mm	160kN



Ναυτικά κλειδιά "Ω" M8260 INOX A4

D	A	R	L	BL
3mm	6mm		12mm	4kN
4mm	8mm	14mm	14mm	6,8kN
5mm	10mm	17mm	17mm	9,8kN
6mm	12mm	21mm	21mm	14,7kN
8mm	16mm	28mm	28mm	24,5kN
10mm	20mm	35mm	35mm	39,2kN
12mm	24mm	42mm	42mm	58,8kN
16mm	32mm	55mm	55mm	98kN

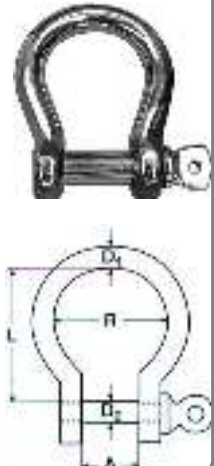

Ναυτικά κλειδιά μακρυνά "D" M8259 INOX A4

D	A	L	BL
4mm	8mm	32mm	6,8kN
5mm	10mm	37mm	8kN
6mm	12mm	45mm	12kN
8mm	16mm	60mm	20kN
10mm	20mm	75mm	40kN
12mm	24mm	92mm	48kN

Σύνδεσμοι αλυσίδας στραβοί M8288 INOX A4

D	A	L	SWL
4mm	8mm	23mm	6,5kN
5mm	10mm	27mm	9,8kN
6mm	12mm	33mm	14,7kN
8mm	16mm	44mm	24,5kN
10mm	20mm	55mm	44,1kN
12mm	24mm	66mm	68,6kN

Ναυτικά κλειδιά χειρασφαλείας M8359 INOX A4

D	A	L
5mm	12mm	38mm
6mm	15mm	45mm
8mm	20mm	60mm

Ναυτικά κλειδιά χειρασφαλείας με θηλιά M8360

INOX A4



D	A	L	L1
5mm	12mm	38mm	12mm
6mm	15mm	45mm	15mm
8mm	20mm	60mm	20mm

Συρματόσχοινα INOX A4

Πάχος
1,0 (7x7)
2,5
3,0
4,0
5,0
6,0
8,0
10,0

**Ροδάντζες συρματόσχοινου M8247 INOX A4**

Ø	A	B	E
2mm	7mm	10mm	2mm
2,5mm	8mm	14mm	2,5mm
3mm	10mm	17mm	3mm
4mm	11mm	18mm	4mm
5mm	13mm	20mm	5,6mm
6mm	15mm	25mm	6,5mm
8mm	18mm	33mm	9mm
10mm	23mm	41mm	11mm
12mm	27mm	48mm	14mm

**Σφυγκτήρες συρματόσχοινου M8248 INOX A4**

D1	D2	B	L
2mm	3mm	16mm	10mm
3mm	4mm	21mm	12mm
4mm	4mm	22mm	12mm
5mm	5mm	23mm	13mm
6mm	5mm	26mm	15mm
8mm	6mm	30mm	19mm
10mm	8mm	34mm	22mm
12mm	10mm	40mm	30mm

**Ταλουρίτ M8026 INOX A4**

D	A	L
2mm	2,3mm	9,3mm
3mm	3,3mm	11mm
4mm	4,4mm	14mm
5mm	5,5mm	18mm
6mm	6,6mm	21mm
8mm	8,8mm	28mm

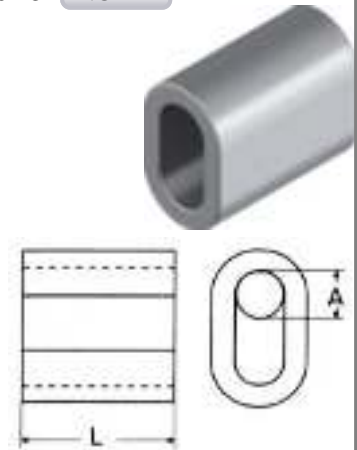
**Σφυγκτήρες μονοί M8330 INOX A4**

Ø	B1	D	H2	L
2mm	12mm	M4	14mm	15mm
3mm	14mm	M4	13mm	18mm
4mm	18mm	M5	18mm	20mm
5mm	20mm	M5	17mm	25mm
6mm	24mm	M6	23mm	30mm
8mm	30mm	M8	30mm	36mm

**Σφυγκτήρες διπλοί M8331 INOX A4**

Ø	B1	D	H2	L
2mm	12mm	M4	14mm	30mm
3mm	14mm	M4	13mm	36mm
4mm	18mm	M5	18mm	40mm
5mm	20mm	M5	17mm	50mm
6mm	24mm	M6	23mm	60mm
8mm	30mm	M8	30mm	72mm

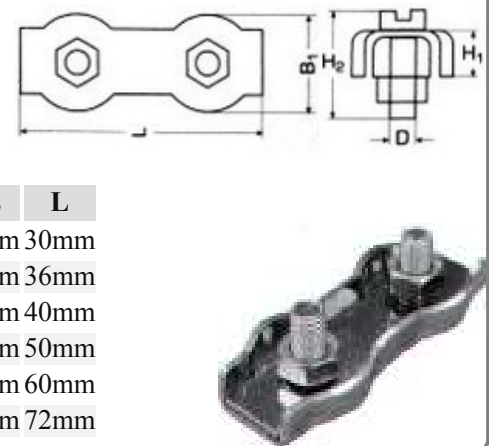
**Στοπ συρματόσχοινου M8427 INOX A4**

Ø	D	A	M
2mm	10mm	8mm	M4
3mm	15mm	12mm	M8
4mm	15mm	12mm	M8
5mm	20mm	15mm	M10
6mm	20mm	15mm	M10

**Στοπ συρματόσχοινου M8426 INOX A4**

Ø	D	A
2mm	16mm	10mm
3mm	16mm	10mm
4mm	16mm	10mm
5mm	20mm	10mm

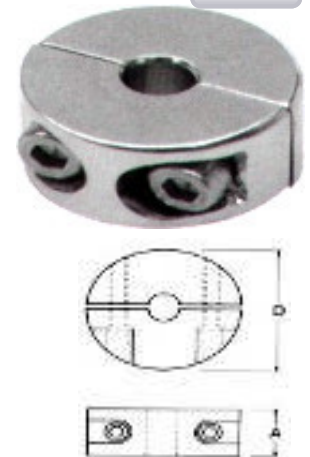

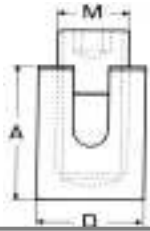
**Συνδετήρες κόμβου M8424 INOX A4**

Ø	D	A	M
2mm	10mm	8mm	M4
3mm	15mm	12mm	M8
4mm	15mm	12mm	M8
5mm	20mm	15mm	M10
6mm	20mm	15mm	M10

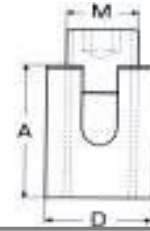
Συνδετήρες κόμβου M8425 INOX A4

Ø	D	A	M
3mm	17mm	19mm	M10
4mm	20mm	21mm	M12
5mm	20mm	23mm	M12

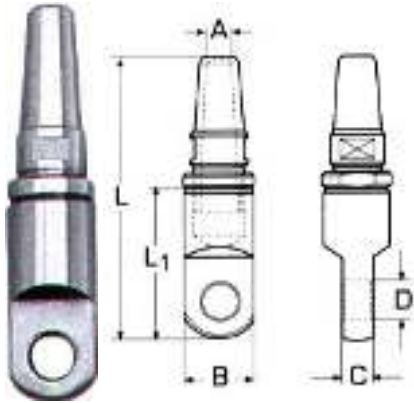
Άκρα συρματόσχοινο M8322 INOX A4

Ø	A	B	C	D	L	L1
4mm	4,5mm	18mm	7mm	8mm	71mm	40mm
5mm	6mm	20mm	9mm	10mm	91mm	45mm
6mm	7mm	24mm	10mm	13mm	98mm	55mm
8mm	9mm	30mm	13mm	15mm	121mm	69mm
10mm	11mm	36mm	13mm	15mm	152mm	80mm

Άκρα συρματόσχοινο M8324 INOX A4

Ø	A	B	L	L1
4mm	4,5mm	18mm	71mm	40mm
5mm	6mm	20mm	129mm	45mm
6mm	7mm	24mm	98mm	55mm
8mm	9mm	30mm	121mm	69mm
10mm	11mm	36mm	152mm	80mm

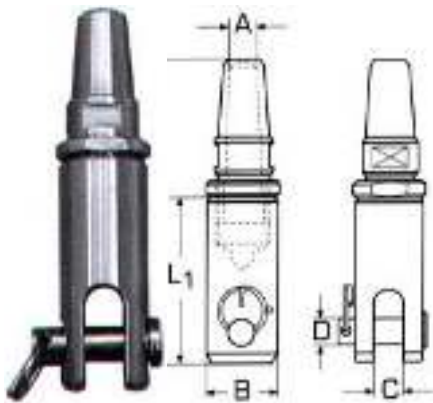
Άκρα συρματόσχοινο M8323 INOX A4

Ø	A	B	C	D	L	L1
4mm	4,5mm	18mm	8mm	6mm	76mm	45mm
5mm	6mm	20mm	10mm	8mm	98mm	52mm
6mm	7mm	24mm	11mm	10mm	106mm	63mm
8mm	9mm	30mm	14mm	10,5mm	134mm	82mm
10mm	11mm	36mm	14mm	12,5mm	166mm	94mm

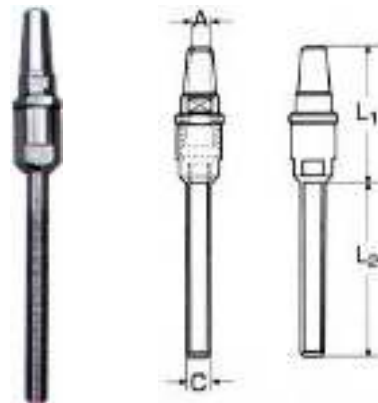
Άκρα συρματόσχοινο M8326 INOX A4

Ø	A	B	C	L2	L1
4mm	4,5mm	18mm	M8	75mm	54mm
5mm	6mm	20mm	M10	100mm	72mm
6mm	7mm	24mm	M12	125mm	75mm
8mm	9mm	30mm	M16	150mm	92mm
10mm	11mm	36mm	M16	150mm	117mm

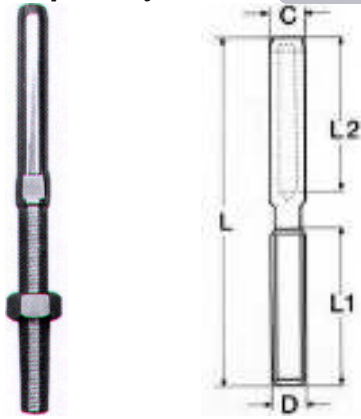
Άκρα πρέσσας M8320 INOX A4

Ø	D	L	L1	L2	C
2mm	M4	73mm	38mm	24mm	4,8mm
2,5mm	M5	86mm	40mm	32mm	5,5mm
3mm	M5	80mm	40mm	32mm	6,3mm
3mm	M6	100mm	48mm	39mm	6,5mm
4mm	M6	110mm	48mm	45mm	7,5mm
4mm	M8	117mm	57mm	45mm	7,5mm
5mm	M8	128mm	57mm	51mm	9,1mm
5mm	M10	130mm	63mm	52mm	9mm
6mm	M10	162mm	80mm	64mm	12,5mm
6mm	M12	162mm	80mm	64mm	12,5mm
8mm	M16	200mm	100mm	80mm	16mm
10mm	M20	230mm	119mm	90mm	18mm
12mm	M20	245mm	120mm	105mm	20mm

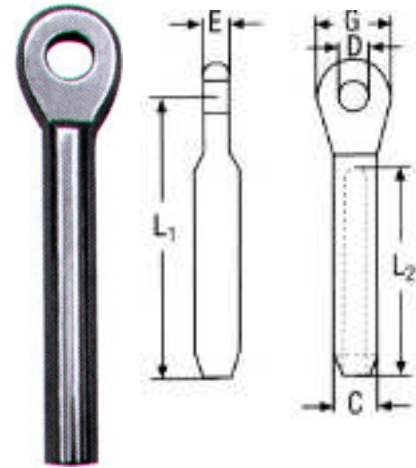
Άκρα πρέσσας M8317 INOX A4

Ø	L1	L2	E	D	C
2,5mm	50mm	30mm	3mm	5,4mm	5,5mm
3mm	55mm	36mm	4mm	6,5mm	6,3mm
4mm	65mm	39mm	6mm	8,5mm	7,5mm
5mm	80mm	50mm	7mm	10mm	9mm
6mm	94mm	62mm	8mm	12,5mm	12,5mm
8mm	124mm	85mm	10mm	14,5mm	16mm
10mm	142mm	90mm	12mm	16,4mm	18mm
12mm	160mm	105mm	16mm	19,3mm	20mm

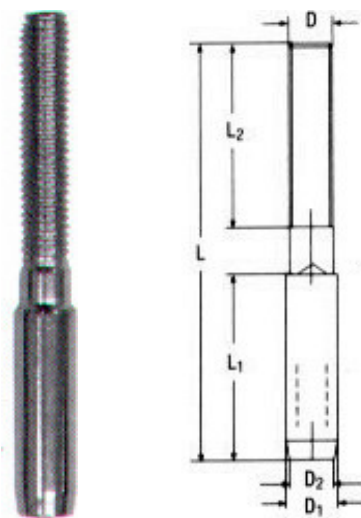
Άκρα πρέσσας M8447 INOX A4

Ø	D	D1	D2	L	L1	L2
4mm	M6	7,5mm	4,3mm	90mm	25mm	60mm
5mm	M8	9mm	5,3mm	100mm	31mm	60mm
6mm	M10	12,5mm	6,3mm	125mm	37mm	80mm

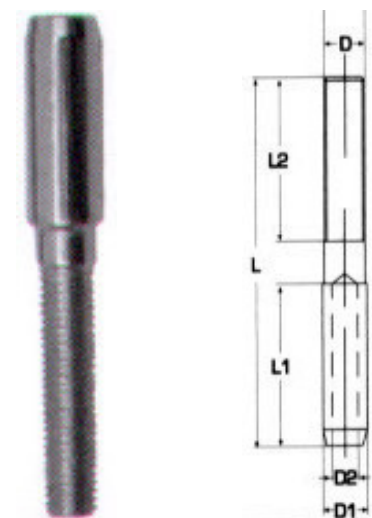
Άκρα πρέσσας M8445 INOX A4

Ø	D	D1	D2	L	L1	L2
4mm	M6	7,5mm	4,3mm	90mm	25mm	25mm
5mm	M8	9mm	5,3mm	100mm	31mm	31mm
6mm	M10	12,5mm	6,3mm	125mm	37mm	40mm

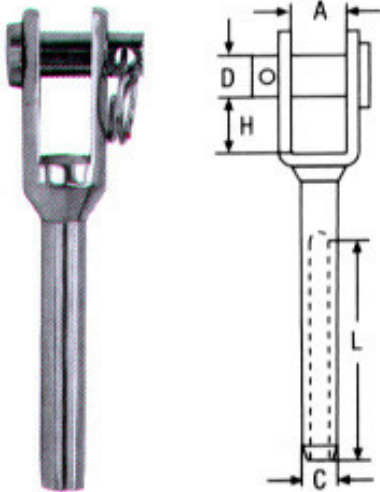
**Άκρα πρέσσας μηχανής M8316MT** INOX A4

Ø	D	A	L	C	H
3mm	6mm	6,3mm	39mm	6,5mm	11mm
4mm	8mm	8mm	45mm	8mm	14mm
5mm	9mm	10mm	52mm	9mm	20mm
6mm	12mm	11mm	64mm	13mm	22mm
8mm	14mm	14mm	80mm	16mm	26mm

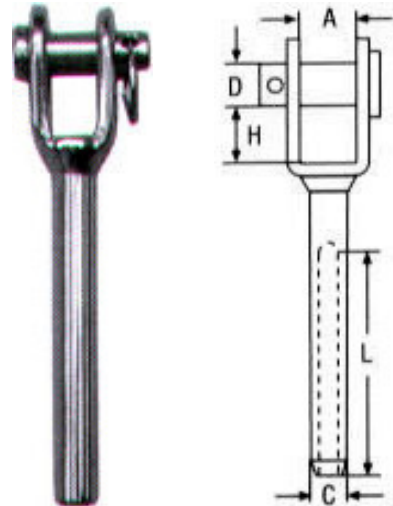
Άκρα πρέσσας κολλητά M8316 INOX A4

Ø	D	A	L	C	H
3mm	6mm	7,5mm	32mm	6,5mm	10mm
4mm	8mm	11mm	40mm	7,5mm	11mm
5mm	9mm	12mm	57mm	9mm	14mm
6mm	12mm	14mm	63mm	12,5mm	20mm
8mm	14mm	17mm	85mm	16mm	26mm

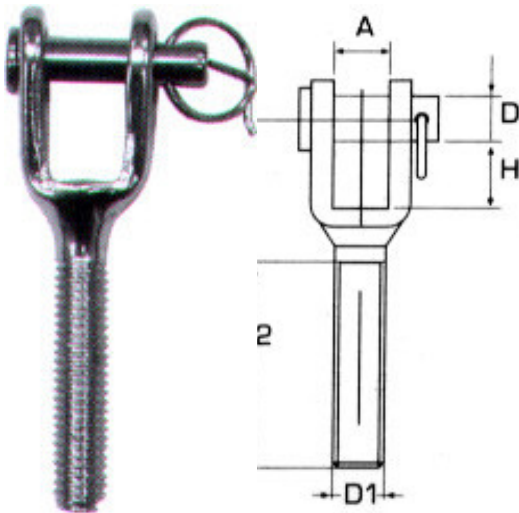
Άκρα πρέσσας δεξιόστροφα M8552 INOX A4

D1	L1	L2	H	A	D
M6	47mm	25mm	10mm	8mm	6mm
M8	52mm	25mm	12mm	10mm	8mm
M10	72mm	45mm	14mm	12mm	10mm

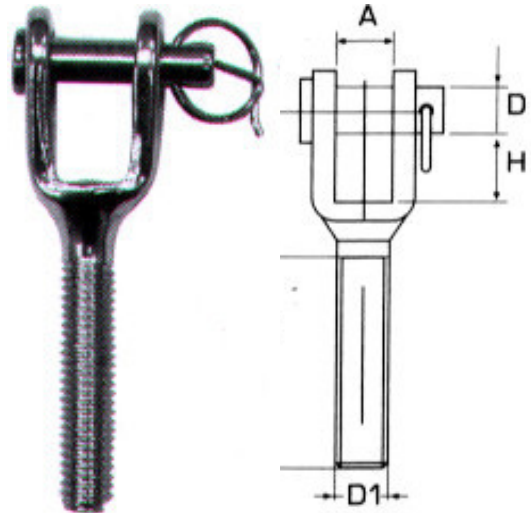
Άκρα πρέσσας αριστερόστροφα M8553 INOX A4

D1	L1	L2	H	A	D
M6	47mm	25mm	10mm	8mm	6mm
M8	52mm	25mm	12mm	10mm	8mm
M10	72mm	45mm	14mm	12mm	10mm

Άκρα πρέσσας με εσωτερικό δεξί πάσο M8455

INOX A4

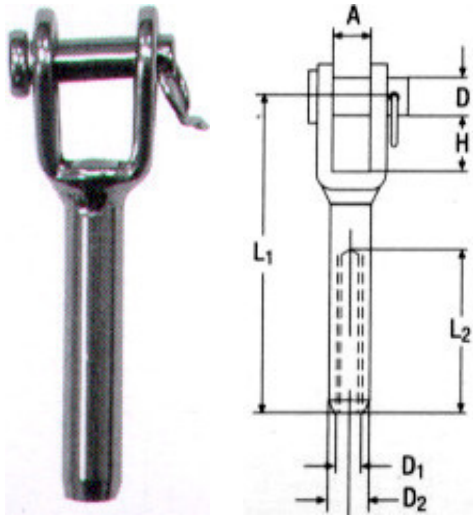

D1	L1	L2	A	D	H	D2
M6	60mm	30mm	9mm	6mm	10mm	8mm
M8	65mm	31mm	10mm	8mm	12mm	12mm
M10	70mm	40mm	12mm	10mm	12mm	14mm

Άκρα πρέσσας με εσωτερικό αριστερό πάσο M8456

INOX A4

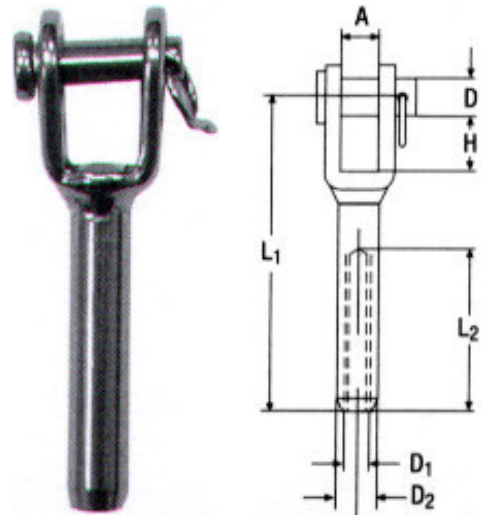

D1	L1	L2	A	D	H	D2
M6	60mm	30mm	9mm	6mm	10mm	8mm
M8	65mm	31mm	10mm	8mm	12mm	12mm
M10	70mm	40mm	12mm	10mm	12mm	14mm

Εντατήρες συρματόσχοινων κολλητοί M8245

INOX A4

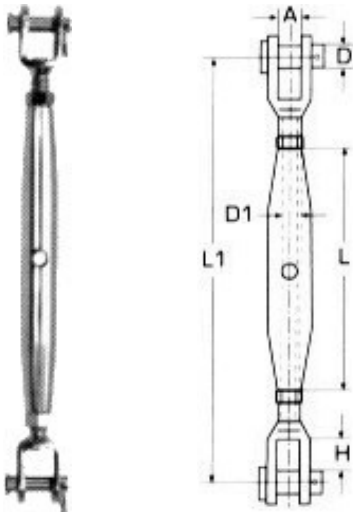

D1	L	L1	A	D	H
M6	95mm	150mm	7,5mm	6mm	10mm
M8	105mm	165mm	11mm	8mm	11mm
M10	125mm	190mm	12mm	9mm	14mm
M12	150mm	245mm	14mm	12mm	20mm
M14	165mm	270mm	15mm	12mm	22mm
M16	190mm	310mm	17mm	16mm	26mm

Εντατήρες συρματόσχοινων μασίφ M8245MT

INOX A4

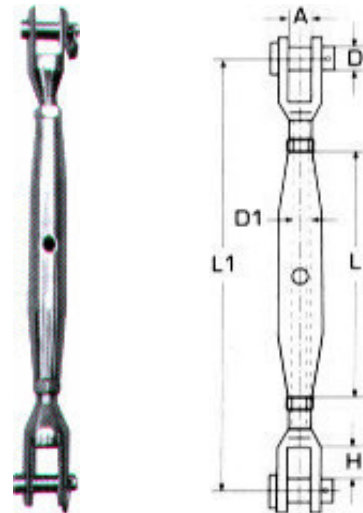

D1	L	L1	A	D	H
M5	70mm	130mm	6,5mm	5mm	10mm
M6	80mm	155mm	7,5mm	6mm	10mm
M8	90mm	180mm	11mm	8mm	11mm
M10	100mm	210mm	12mm	9mm	14mm
M12	140mm	270mm	14mm	12mm	20mm
M16	170mm	340mm	17mm	16mm	26mm

Εντατήρες συρματόσχοινων με τερματικό M8275

INOX A4

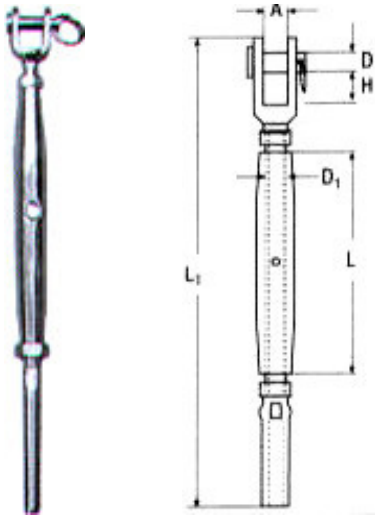

D1	Ø	L	L1	A	D	H
M6	3mm	95mm	175mm	7,5mm	6mm	10mm
M8	4mm	105mm	200mm	11mm	8mm	11mm
M10	5mm	125mm	230mm	12mm	9mm	14mm
M12	6mm	150mm	285mm	14mm	12mm	20mm
M16	8mm	190mm	360mm	17mm	16mm	26mm

Εντατήρες συρματόσχοινων με τερματικό M8275MT

INOX A4

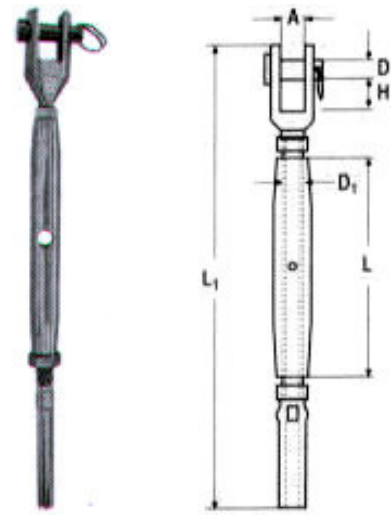

D1	Ø	L	L1	A	D	H
M6	3mm	95mm	175mm	7,5mm	6mm	10mm
M8	4mm	105mm	200mm	11mm	8mm	11mm
M10	5mm	125mm	230mm	12mm	9mm	14mm
M12	6mm	150mm	285mm	14mm	12mm	20mm
M16	8mm	190mm	360mm	17mm	16mm	26mm

Εντατήρες συρματόσχοινων με σπαστή κεφαλή M8476

INOX A4

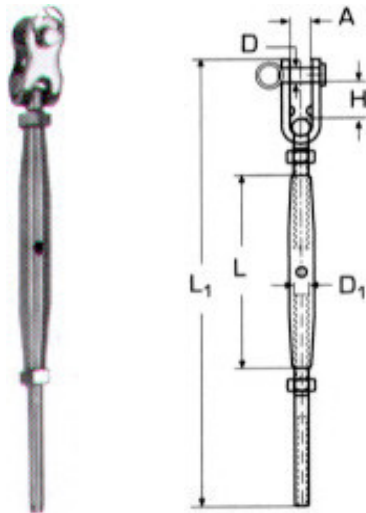

D1	Ø	L	L1	A	D	H
M6	3mm	95mm	175mm	7,5mm	6mm	15mm
M8	4mm	105mm	200mm	11mm	8mm	20mm
M10	5mm	125mm	230mm	12mm	9mm	25mm
M12	6mm	150mm	285mm	14mm	12mm	30mm
M16	8mm	190mm	360mm	17mm	16mm	40mm
M20	10mm	210mm	450mm	20mm	19mm	45mm

Εντατήρες συρματόσχοινων με θηλιές M8246A

INOX A4

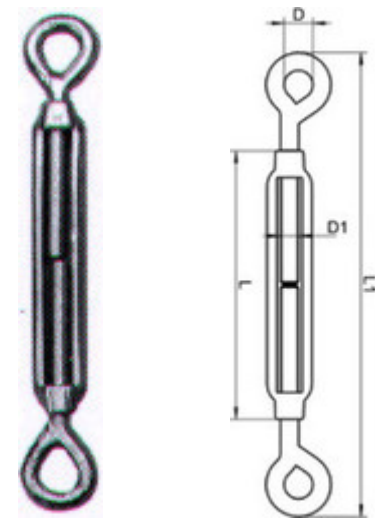

D1	L	L1	D
M5	70mm	120mm	8mm
M6	90mm	150mm	10mm
M8	120mm	200mm	14mm
M10	150mm	240mm	16mm
M12	200mm	310mm	18mm
M16	250mm	390mm	26mm
M20	300mm	440mm	30mm

**Εντατήρες συρματόσχοινων με γάντζους M8246B**

INOX A4

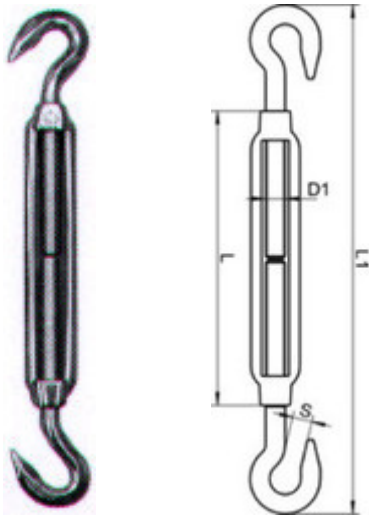

D1	L	L1	D	S
M5	70mm	120mm	8mm	8mm
M6	90mm	150mm	10mm	9mm
M8	120mm	200mm	14mm	11mm
M10	150mm	240mm	16mm	12mm
M12	200mm	310mm	18mm	14mm
M16	250mm	390mm	26mm	16mm
M20	300mm	440mm	30mm	18mm

Εντατήρες συρματόσχοινων με γάντζο - θηλιά

M8246C INOX A4

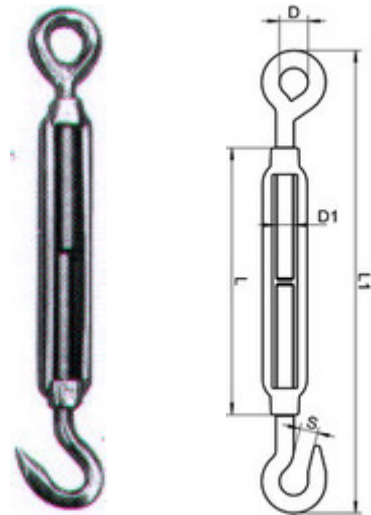

D1	L	L1	D	S
M5	70mm	120mm	8mm	8mm
M6	90mm	150mm	10mm	9mm
M8	120mm	200mm	14mm	11mm
M10	150mm	240mm	16mm	12mm
M12	200mm	310mm	18mm	14mm
M16	250mm	390mm	26mm	16mm
M20	300mm	440mm	30mm	18mm

Κλειδιά γενικής χρήσης M8306

INOX A4



B	L
???	87mm

Γάντζοι αλυσίδας M8388 INOX A4

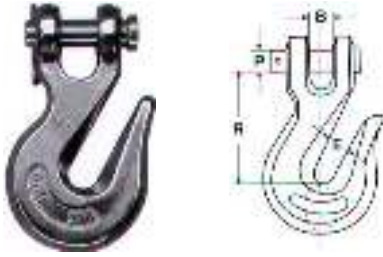

Ø	B	E	P	R
6	11mm	9mm	9mm	46mm
8	13mm	11mm	11mm	54mm
10	15mm	12mm	12mm	58mm

Γάντζοι με πύρο M8334 INOX A4



L	A	B
52mm	12mm	10mm
66mm	15mm	14mm
96mm	20mm	18mm

Γάντζοι με πύρο M8263 INOX A4

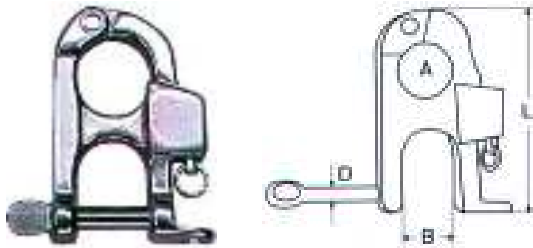

D	A	B	L
5mm	15mm	16mm	60mm

Γάντζοι με πύρο και στριφτάρι M8252 INOX A4



L	A	B
68mm	12mm	12mm
87mm	16mm	14mm
128mm	22mm	22mm

Γάντζοι με πύρο, στριφτάρι και ναυτικό κλειδί M8262 INOX A4

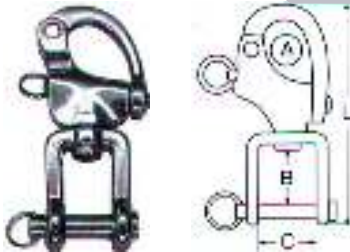

L	A	B	C
70mm	12mm	12mm	12mm
87mm	16mm	13mm	13mm
128mm	22mm	16mm	19mm

Γάντζοι με πύρο και θηλιά M8297 INOX A4



L	A	B
52mm	12mm	9mm
66mm	16mm	12mm
96mm	22mm	16mm

Γάντζοι πελεκάνος M8157 INOX A4

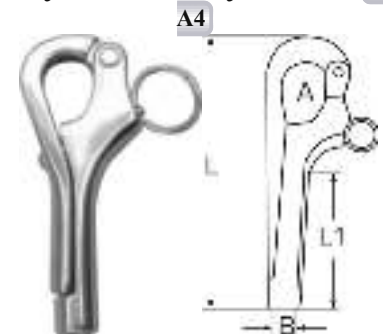

L	L1	A	B
76mm	39mm	13mm	M6X9
100mm	48mm	16mm	M8X12

Στριφτάρια μάτι - μάτι M8254 INOX A4

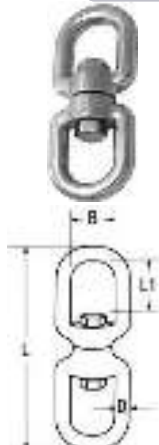

D	L	L1	B
5mm			
6mm	65mm	15mm	15mm
8mm	90mm	22mm	20mm
10mm	115mm	27mm	24mm
13mm	154mm	35mm	32mm
16mm	168mm	45mm	39mm

Στριφτάρια μάτι - ναυτικό M8255 INOX A4

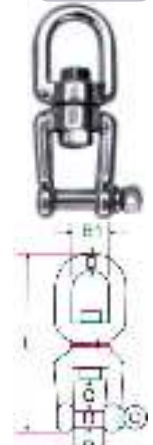

D	L	B	C	B1
6mm	66mm	12mm	11mm	15mm
8mm	92mm	16mm	16mm	20mm
10mm	118mm	20mm	22mm	24mm
13mm	152mm	26mm	28mm	32mm
16mm	188mm	32mm	37mm	39mm
19mm	229mm	38mm	45mm	42mm

Στριφτάρια ναυτικό - ναυτικό M8256 INOX A4

D	L	B	C
6mm	66mm	12mm	12mm
8mm	94mm	16mm	16mm
10mm	118mm	20mm	22mm
13mm	152mm	26mm	28mm
16mm	188mm	32mm	37mm
19mm	229mm	38mm	44mm

**Γάντζοι πυροσβεστικοί M8249 INOX A4**

D	L	A	E
4mm	40mm	5mm	6mm
5mm	50mm	6mm	7mm
6mm	60mm	7mm	8mm
7mm	70mm	10mm	9mm
8mm	80mm	12mm	10mm
10mm	100mm	15mm	12mm
11mm	120mm	18mm	16mm
12mm	140mm	20mm	19mm

**Γάντζοι πυροσβεστικοί με θηλιά M8250 INOX A4**

D	L	A	E
4mm	40mm	5mm	6mm
5mm	50mm	6mm	7mm
6mm	60mm	7mm	8mm
7mm	70mm	9mm	8mm
8mm	80mm	10mm	9mm
10mm	100mm	13mm	12mm
11mm	120mm	15mm	16mm
12mm	140mm	18mm	19mm

**Γάντζοι πυροσβεστικοί με πλάγιο άνοιγμα M8010 INOX A4**

D	L	A	E
8mm	80mm	12mm	19mm
10mm	100mm	15mm	22mm
11mm	120mm	18mm	26mm

**Πυροσβεστικοί γάντζοι με παξιμάδι M8004 INOX A4**

D	L	A	E
6mm	60mm	9mm	8mm
8mm	80mm	12mm	9mm
10mm	100mm	15mm	12mm
11mm	120mm	18mm	16mm

**Πυροσβεστικοί γάντζοι με παξιμάδι και θηλιά M8005 INOX A4**

D	L	A	E
6mm	60mm	9mm	8mm
8mm	80mm	12mm	9mm
10mm	100mm	13mm	12mm
11mm	120mm	15mm	16mm

**Πυροσβεστικοί γάντζοι αχλάδι M8054 INOX A4**

D	L	A	E
6mm			
8mm	80mm	12mm	13mm
10mm	100mm	15mm	18mm
11mm	120mm	18mm	24mm

**Πυροσβεστικοί γάντζοι αχλάδι με θηλιά M8055 INOX A4**

D	L	A	E
6mm	60mm	10mm	7,5mm
8mm	80mm	13mm	10mm
10mm	100mm	18mm	13mm
11mm	120mm	24mm	15mm



Πυροσβεστικοί γάντζοι διπλή ασφάλεια & θηλιά M8338 INOX A4



D	L	A	E
1mm	110mm	20mm	20mm

Πυροσβεστικοί γάντζοι γαμπού M8251 INOX A4



L	W	E	D
50mm	24mm	10mm	6,5mm
70mm	31mm	13mm	10mm
100mm	46mm	23mm	13mm

Γάντζοι με θηλιά HL0604 INOX A4



Πάχος θηλιάς	B	L	O
1/4"	13mm	91mm	22mm
5/16"	16mm	108mm	24mm
3/8"	18mm	124,5mm	28mm
1/2"	24mm	161mm	37mm

Γάντζοι με στριφτάρι HL0605 INOX A4



Πάχος θηλιάς	B	L	O
1/4"	22mm	119mm	22,5mm
5/16"	27,5mm	141,5mm	24mm
3/8"	28mm	160,5mm	28,5mm
1/2"	35,7mm	199,5mm	36mm

Πυροσβεστικοί γάντζοι γαμπού με νόχι M8153 INOX A4



A	B	L
7,5mm	6,5mm	50mm
9mm	8mm	55mm
11mm	10mm	65mm

Γάντζοι διπλοί M8416 INOX A4

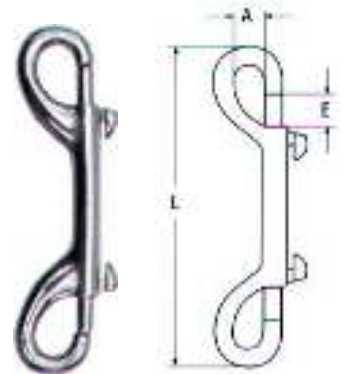

L	E	A
90mm	6mm	6mm
100mm	10mm	10mm
120mm	12mm	11mm

Γάντζοι παγουριού με στριφτάρι M8257 INOX A4



L	D	E	A
85mm	5mm	10mm	16mm
100mm	6mm	12mm	19mm
115mm	7mm	15mm	22mm

Γάντζοι παγουριού με στριφτάρι M8303 INOX A4



L	D1	E	A
62mm	3mm	7mm	10mm
75mm	4mm	8mm	13mm
87mm	5mm	9mm	16mm
90mm	5mm	10mm	19mm
120mm	6mm	14mm	33mm

Κρεμαστράκι M8399 INOX A4

W	H
40mm	31mm

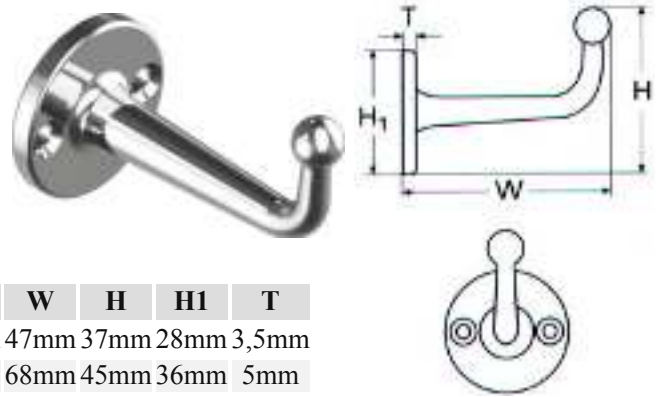
Κρεμάστρες M8361 INOX A4

W	H	H1	T
A 47mm	37mm	28mm	3,5mm
B 68mm	45mm	36mm	5mm

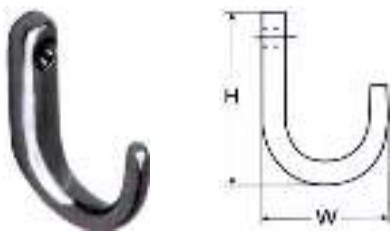
Κρεμαστράκι M8370 INOX A4

W	H
40mm	31mm

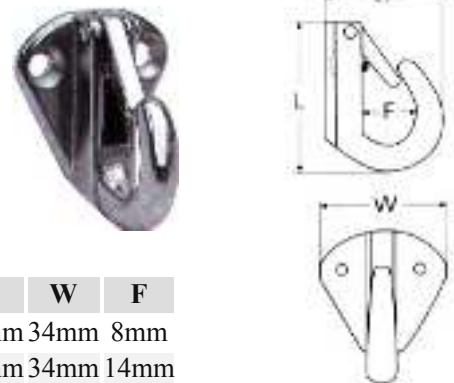
Κρεμαστράκια Steyr M8375 INOX A4

H	L	W	F
A 24mm	38mm	34mm	8mm
B 34mm	40mm	34mm	14mm

Γωνίες βίδα M8707 INOX A4

D	L1	L2
3mm	30mm	10mm
3,5mm	40mm	10mm
4mm	45mm	15mm
4,5mm	50mm	20mm
5mm	60mm	20mm

**Γάντζοι βίδα M8706 INOX A4**

D	L	W
3,3mm	40mm	14mm
3,5mm	50mm	17mm
3,5mm	60mm	16mm
4,4mm	50mm	16mm
4,4mm	65mm	22mm
5,2mm	80mm	26mm
6mm	100mm	26mm

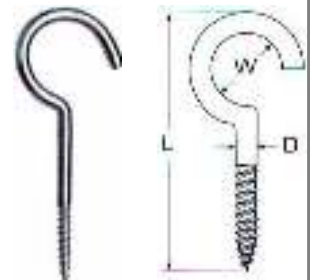



Ράουλα M8369 INOX A4

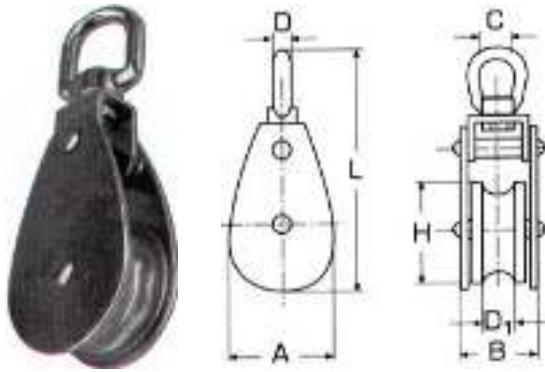

H	D1	L	C	D	A	B
A 25mm	10mm	88mm	13mm	5mm	27mm	24mm
B 32mm	10mm	98mm	13mm	6mm	35mm	42mm
C 50mm	14mm	142mm	20mm	8mm	54mm	54mm

Ράουλα M8393 INOX A4

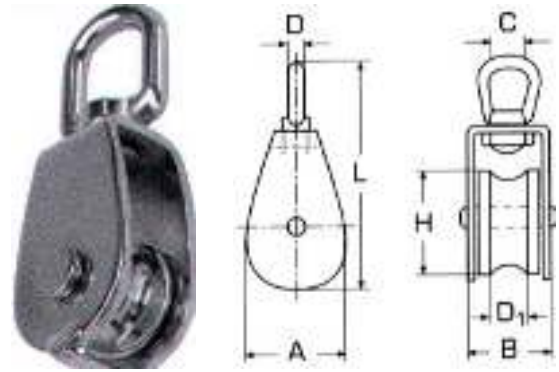

H	D1	L	C	D	A	B
A 25mm	12mm	83mm	15mm	6mm	30mm	24mm
B 32mm	12mm	97mm	16mm	6mm	36mm	24mm
C 50mm	15mm	127mm	20mm	8mm	54mm	28mm

Ράουλα M8392 INOX A4

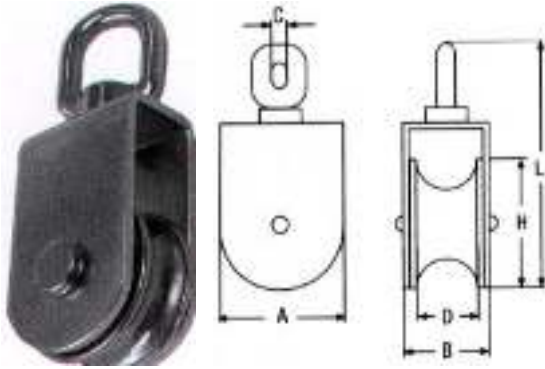

H	L	D	A
A 50mm	127mm	14mm	52mm
B 75mm	170mm	15mm	78mm
C 100mm	205mm	17,5mm	104mm

Τροχαλίες με πλαστικό ράουλο M8389 INOX A4

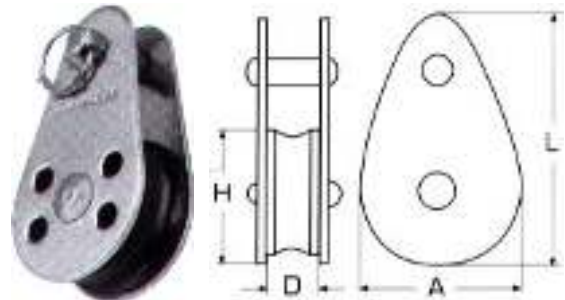

H	L	D	A
25mm	45mm	6,5mm	25mm

Ράουλα σωλήνων μονά M8291 INOX A4

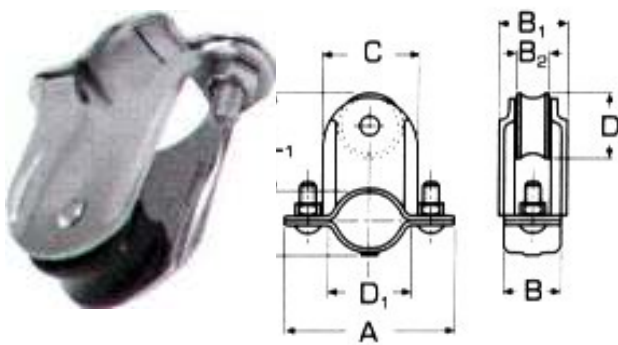

D	B1	B2	B	D1	A	L	C
Ø24	25mm	14mm	20mm	25mm	62mm	80mm	36mm
Ø24	25mm	14mm	20mm	25mm	62mm	80mm	36mm

Ράουλα διπλά M8390 INOX A4

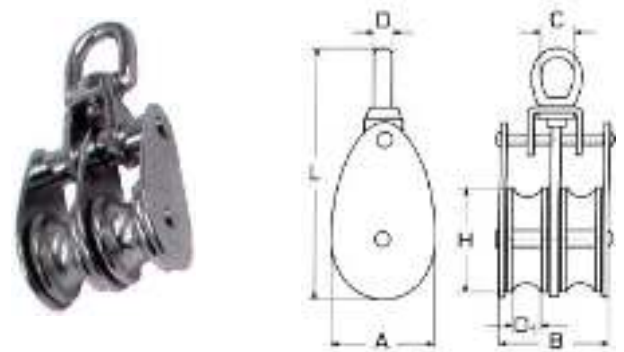

H	D1	L	C	D	A	B
A 25mm	10mm	88mm	13mm	5mm	27mm	37mm
B 32mm	10mm	98mm	13mm	6mm	35mm	42mm
C 50mm	14mm	142mm	20mm	8mm	54mm	54mm

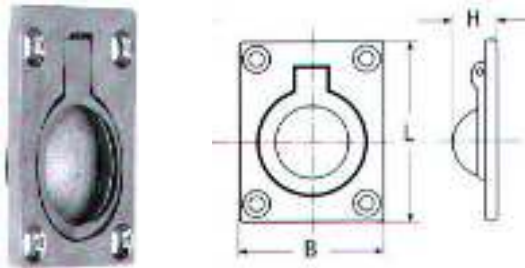
Χούφτες χυτές M8241 INOX A4

L	B	H
46mm	38mm	12mm

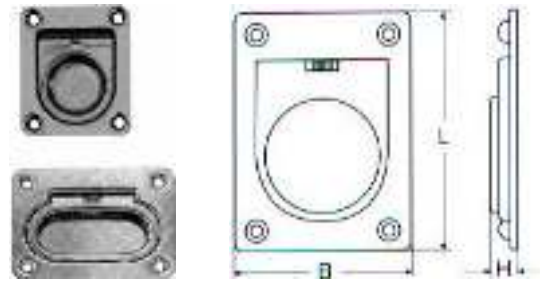
Χούφτες αμπαριού M8118 INOX A4

L	B	H
A 65mm	55mm	11mm
B 57mm	76mm	11mm

Χούφτες χυτές στρόγγυλες M8441 INOX A4

D	H
50mm	10mm

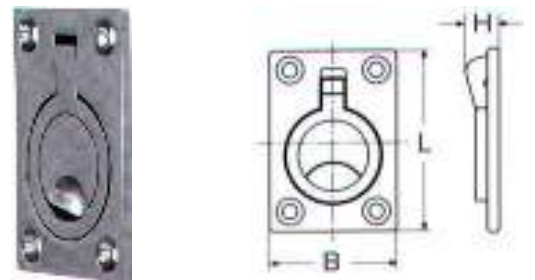
Χούφτες χυτές M8242 INOX A4

L	B	H
63mm	44mm	12mm

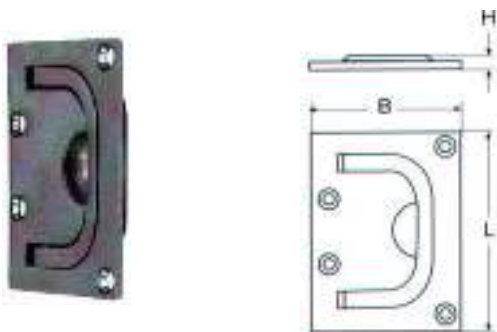
Χούφτες χυτές M8243 INOX A4

L	B	H
76mm	56mm	9mm

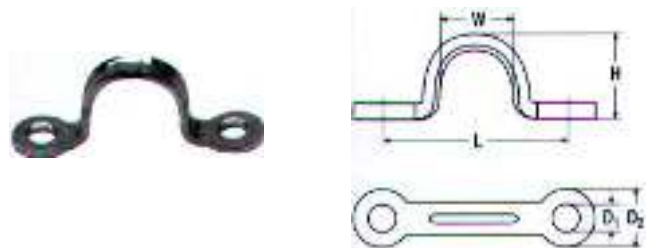
Ωμέγα λάμας M8127 INOX A4

D1	D2	L	W	H
4,2mm	10mm	29mm	13mm	12mm
5mm	11mm	35mm	16mm	16mm
5,3mm	12mm	45mm	21mm	21mm

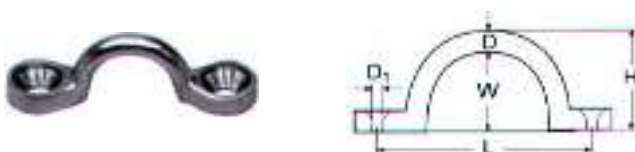
Ωμέγα χυτά M8227 INOX A4

D	L	H	W	D1
5mm	34mm	15mm	10mm	5,3mm

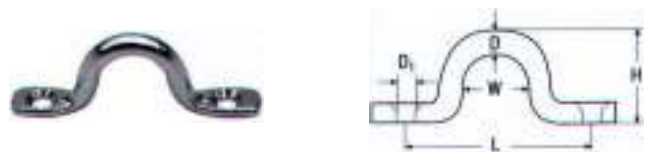
Ωμέγα χυτά M8226 INOX A4

D	L	H	W	D1
5mm	38mm	18mm	16mm	4,2mm
6mm	48mm	22mm	20mm	5,2mm
8mm	49mm	24mm	20mm	5,6mm

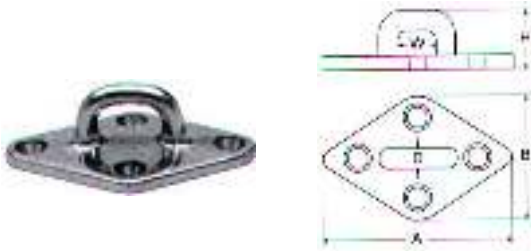
Μάπα με πλάκα ρόμβο M8223 INOX A4

A	B	W	H	D
A 80mm	50mm	19mm	24mm	7,5mm
B 90mm	55mm	22mm	28mm	8mm
C 100mm	62mm	25mm	34mm	9mm

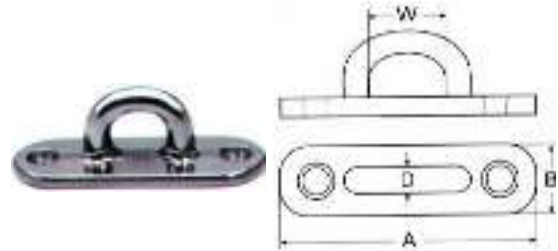
Μάπα με πλάκα οβάλ M8224 INOX A4

A	B	W	D
A 75mm	22mm	16mm	7,5mm
B 88mm	32mm	19mm	8mm
C 100mm	36mm	22mm	9mm

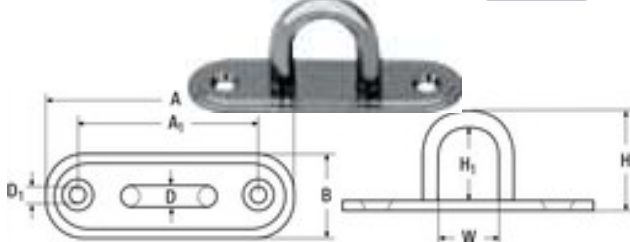
Μάπα με πλάκα οβάλ M8266 INOX A4

A	B	D	A1	H	H1	W	D1
A 45mm	15mm	5mm	31mm	20mm	13mm	12mm	4mm
B 60mm	20mm	6mm	43mm	26mm	19mm	19mm	5mm
C 80mm	26mm	8mm	56mm	32mm	22mm	22mm	6mm
D 100mm	36mm	9mm	70mm	38mm	27mm	26mm	6,5mm

Μάπα με πλάκα ρόμβο M8264 INOX A4

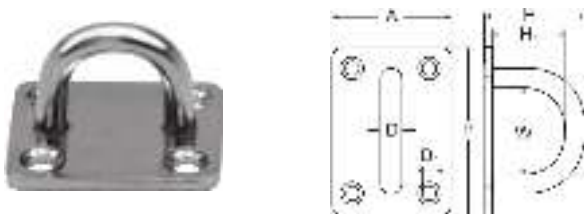

A	B	W	H	D	D1
A 59mm	37mm	11mm	22mm	5mm	4,2mm
B 64mm	40mm	15mm	27mm	6mm	4,2mm
C 80mm	50mm	18mm	32mm	8mm	5,5mm

Μάπα με τετράγωνη πλάκα M8225 INOX A4

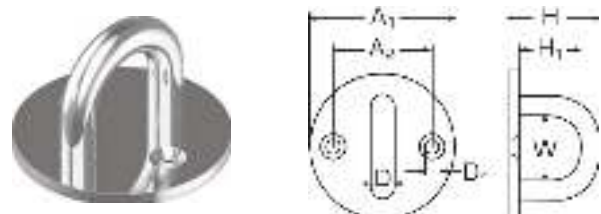
A	B	H	H1	W	D	D1
A 30mm	35mm	19mm	12mm	14mm	5mm	4,2mm
B 35mm	40mm	26mm	17mm	18mm	6mm	4,2mm
C 40mm	50mm	33mm	22mm	20mm	8mm	5,2mm

Μάπα με στρόγγυλη πλάκα M8353 INOX A4

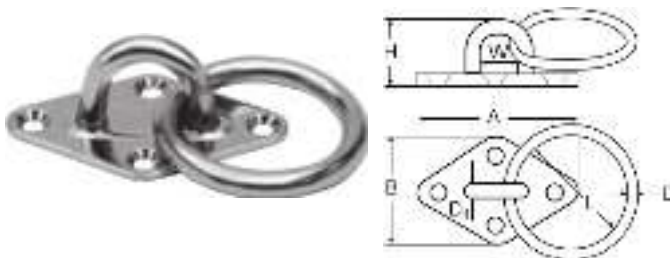
A1	A2	H	H1	W	D	D1
A 33mm	18mm	19mm	11mm	13mm	5mm	4,5mm
B 40mm	22mm	26mm	17mm	16mm	6mm	4,5mm
C 50mm	28mm	32mm	21mm	20mm	8mm	4,5mm

Μάπα με πλάκα και κρίκο M8265 INOX A2

A	B	H	W	D	D1	L
A 59mm	37mm	22mm	11mm	5mm	4,2mm	30mm
B 64mm	40mm	22mm	15mm	6mm	6mm	35mm
C 80mm	50mm	32mm	18mm	8mm	8mm	45mm

Θηλιές μάντα M8366 INOX A2

L	W	H	D	D1
A 52mm	28mm	9,5mm	5mm	4,5mm
B 62mm	38mm	9,5mm	5mm	4,5mm

Μάπες αρσενικές με κοντό σπείρωμα DIN580

INOX A4

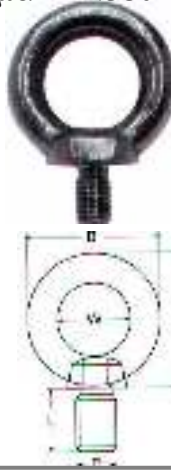

D	L	B	H	W
M6	10mm	28mm	28mm	17mm
M8	13mm	36mm	36mm	20mm
M10	17mm	45mm	45mm	25mm
M12	20,5mm	54mm	53mm	30mm
M16	27mm	63mm	62mm	35mm
M20	30mm	72mm	71mm	40mm

Μάπες θηλυκές DIN582

INOX A4



D	H	B	W
M6	27mm	27mm	16mm
M8	36mm	36mm	20mm
M10	45mm	45mm	25mm
M12	53mm	54mm	30mm
M16	63mm	62mm	35mm
M20	109mm	108mm	65mm

Μάπες στριφώνι M8268

INOX A4

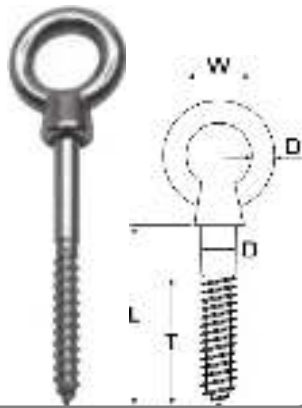

D	L1	T	D1	D2
5mm	50mm	30mm	5mm	11mm
6mm	60mm	35mm	5mm	14mm
8mm	80mm	50mm	6mm	18mm
10mm	100mm	60mm	8mm	22mm

Μάπες αρσενικές M8267

INOX A4

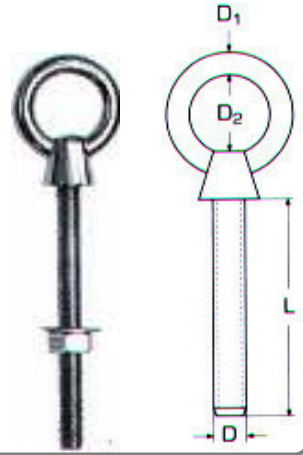

D	L1	D1	D2
M6	60mm	5mm	15mm
M6	80mm	5mm	15mm
M8	80mm	6mm	20mm
M8	100mm	6mm	20mm
M10	80mm	8mm	25mm
M10	100mm	8mm	25mm
M12	100mm	10mm	30mm
M12	120mm	10mm	30mm

Μάπες αρσενικές με κρίκο M8228

INOX A4



D	D1	L	T	W
M6	6mm	90mm	55mm	35mm
M8	8mm	100mm	60mm	45mm
M10	10mm	130mm	80mm	50mm
M12	12mm	150mm	90mm	60mm

Βιδοθηλιές M8705

INOX A4

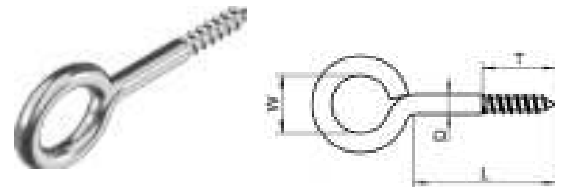

D	L	T	W
3,3mm	16mm	10mm	8mm
3,7mm	20mm	12mm	10mm
4mm	25mm	15mm	12mm
4,4mm	30mm	18mm	14mm

U-bolts M8230

INOX A4



D1	L1	L2	D	L
M4	30mm	62mm	5mm	30mm
M5	48mm	78mm	6mm	36mm
M6	42mm	80mm	8mm	36mm
M8	40mm	90mm	10mm	35mm
M8	52mm	100mm	10mm	45mm
M10	35mm	90mm	12mm	50mm
M10	55mm	110mm	12mm	50mm
M10	80mm	135mm	12mm	50mm
M12	65mm	130mm	14mm	60mm
M12	85mm	150mm	14mm	60mm

**Περσίδες παραλληλόγραμμες M8057A** INOX A2

Μήκος Πλάτος Πάχος
127mm 66mm 0,6mm

Περσίδες τετράγωνες M8057B INOX A2

Μήκος Πλάτος Πάχος
120mm 120mm 0,6mm

Περσίδες μακρόστενες M8057C INOX A2

Μήκος Πλάτος Πάχος
230mm 115mm 0,6mm

Περσίδες μακρόστενες M8057D INOX A2

Μήκος Πλάτος Πάχος
358mm 184mm 0,6mm

Περσίδες στρόγγυλες M8057E INOX A2

Διάμετρος Πάχος
125mm 0,6mm

Περσίδες στρόγγυλες M8057F INOX A2

Με κλαπέ



Διάμετρος Πάχος
125mm 0,7mm

Περσίδες παραλληλόγραμμες M8057G INOX A2

Κάθετες



Μήκος Πλάτος Πάχος
227mm 126mm 0,6mm

Περσίδες στενές με σίτα M8057H INOX A2

Μήκος Πλάτος
212mm 57mm

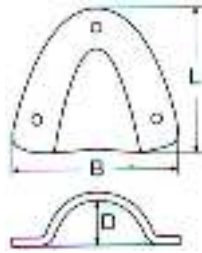
Αεραγωγοί M8345 INOX A4

L	B	D
---	---	---

57mm	55mm	16mm
------	------	------

Σύρμα μαλακό σε κουλούρα INOX 316I**Πάχος**

0,5mm	½kg
0,8mm	1kg
1mm	1kg
1,2mm	1kg
1,5mm	1kg
2mm	1kg

Σίτες INOX AISI 304

Σε κουλούρες 30m

Τύπος	Πάχος
MESH3	1,00mm
MESH5	1,04mm
MESH8	0,71mm
MESH12	0,50mm
MESH16	0,45mm
MESH20	0,30mm
MESH24	0,35mm
MESH30	0,30mm
MESH40	0,19mm
MESH50	0,18mm
MESH80	0,12mm
MESH120	0,08mm

**Πλέγματα κολλητά INOX AISI 304**

Σε κουλούρες 30m

Τύπος

10X10X1mm
12X12X1mm
16X16X1mm
16X16X1,5mm
20X20X1,5mm
25X25X2mm
30X30X2mm
35X35X2,5mm
40X40X3mm



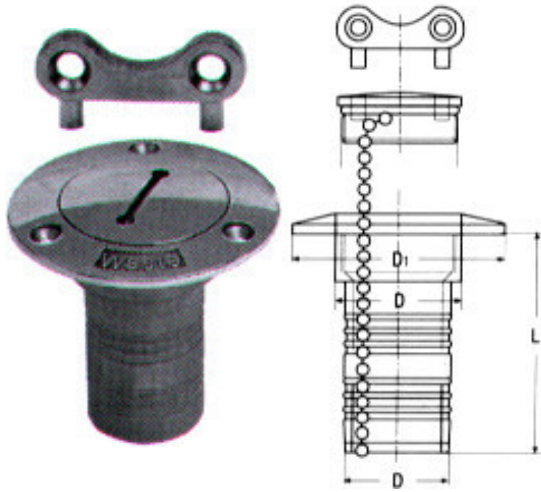

Τάπες καταστρώματος με κλειδί M8111 INOX A4

Τύπος	D	L	D1	Αλυσίδα
Αποβλήτων	38mm	78mm	75mm	✗
Πετρελαίου	38mm	78mm	75mm	✓
Πετρελαίου	51mm	79mm	87mm	✓
Νερού	38mm	78mm	75mm	✓
Νερού	51mm	79mm	87mm	✓

Οπές κύτους ανοικτές M8351 INOX A4

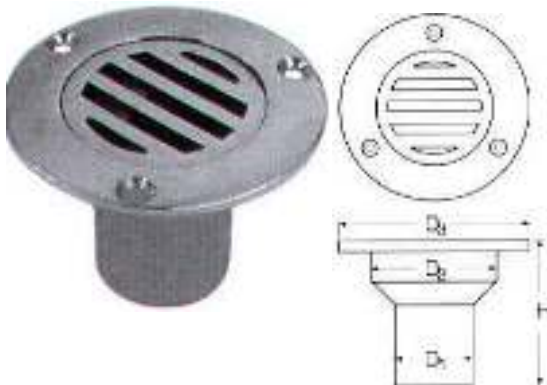
D	L	D1
1/2"	65mm	40mm
3/4"	71mm	48mm
1"	78mm	54mm
1 1/4"	84mm	70mm
1 1/2"	84mm	71mm

Οπές κύτους με σχάρα M8452 INOX A4

D1	D2	D3	H
37mm	58mm	82mm	60mm

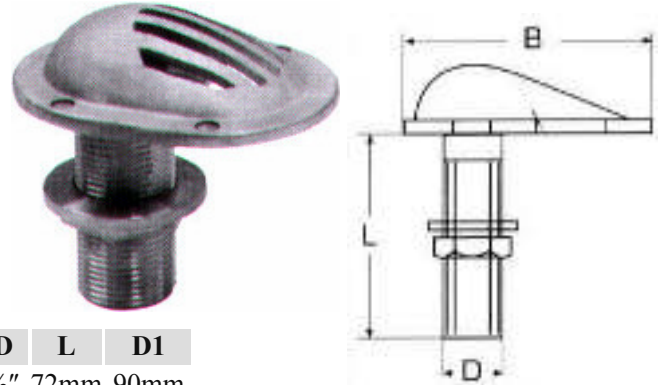
Οπές κύτους κούρμα με σχάρα M8352 INOX A4

D	L	D1
1/2"	72mm	90mm
3/4"	80mm	104mm
1"	77mm	107mm
1 1/4"	79mm	118mm
1 1/2"	80mm	132mm

Βαλβίδες εξαέρωσης M8286 INOX A4



Πάσο	D	L
A M19	16mm (9/16")	75mm
B M27	25mm (1")	75mm

Βαλβίδες εξαέρωσης M8287 INOX A4

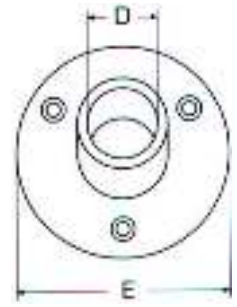

Πάσο	D	L
A M19	16mm (9/16")	88mm

Ποτήρια σωλήνα M8270 INOX A4

B	D1	D2	D3	E	H
	22mm			58mm	
	25mm			58mm	

Στρόγγυλη χυτή βάση 82° M8283 INOX A4

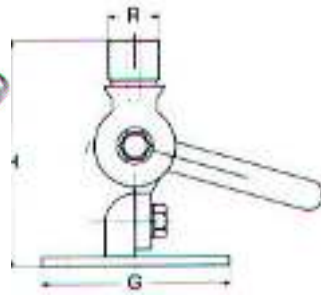
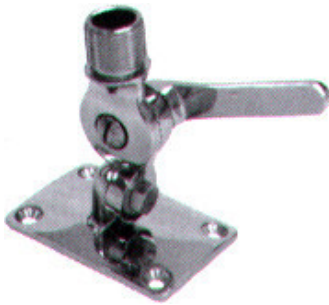
D	E	H
25mm	67mm	52mm

Βάση κεραίας M8279 INOX A4

G	F	H	R
92mm	64mm	108mm	3/4"

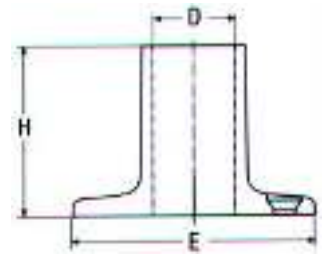
Βάση κεραίας 90° στρόγγυλη M8201 INOX A4

G	E	H
22mm	66mm	43mm
25mm	70mm	43mm

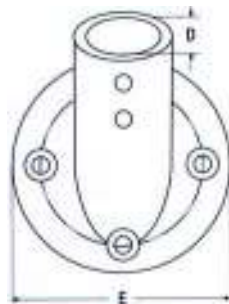
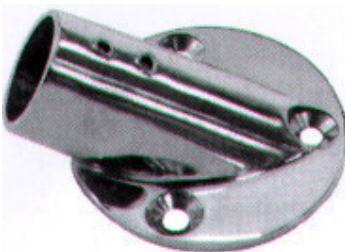
Βάση κεραίας 30° στρόγγυλη M8325 INOX A4

G	E	H
22mm	66mm	39mm
25mm	70mm	39mm

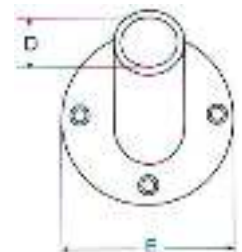
Βάση κεραίας 60° στρόγγυλη M8202 INOX A4

G	E	H
22mm	66mm	43mm
25mm	70mm	46mm

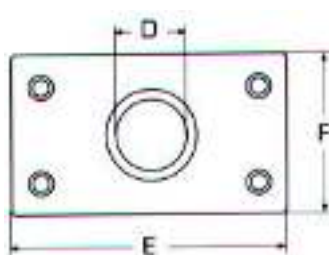
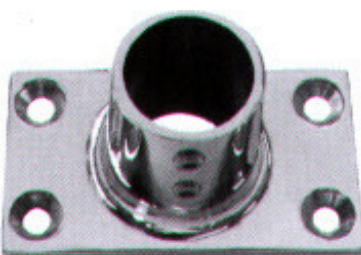
Βάση κεραίας 90° με τετράφωνη βάση M8203 INOX A4

D	F	E	H
22mm	76mm	44mm	43mm
25mm	81mm	48mm	43mm

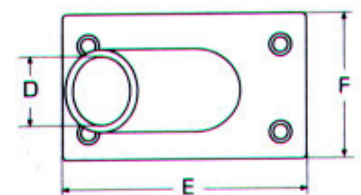
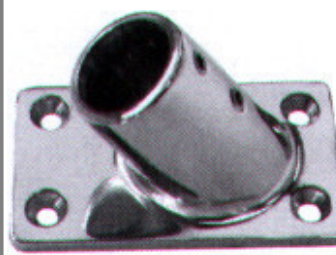
Βάση κεραίας 60° με τετράφωνη βάση M8204 INOX A4

D	F	E	H
22mm	76mm	44mm	43mm
25mm	81mm	48mm	43mm

Βάση λοξή 60° διαπερής M8207 INOX A4

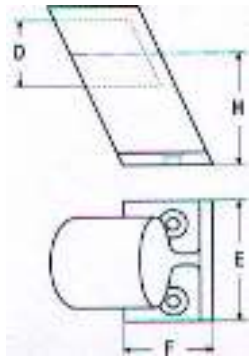

G H F E
 22mm 37mm 26mm 40mm
 25mm 40mm 29mm 42mm

Βάση λοξή 60° διαπερής M8209 INOX A4

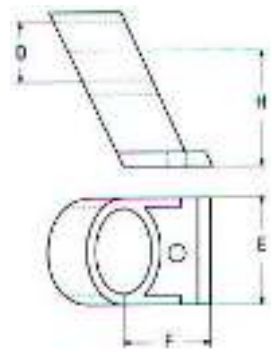

D H F E
 22mm 38mm 33mm 35mm
 25mm 38mm 33mm 35mm

Βάση λοξή 60° τερματική M8208 INOX A4

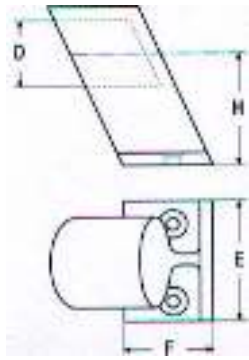

G H F E
 22mm 37mm 26mm 40mm
 25mm 40mm 29mm 42mm

Βάση λοξή 60° διαπερής M8276 INOX A4

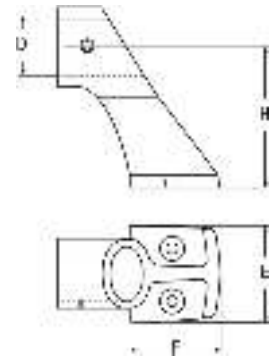

D H F E
 22mm 52mm 33mm 36mm

Βάση λοξή 60° τερματική M8213 INOX A4

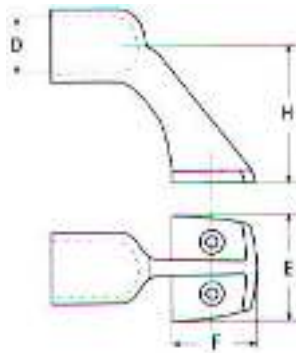

D H F E
 22mm 52mm 33mm 36mm

Σύνδεσμοι T χυτοί 60° M8206 INOX A4

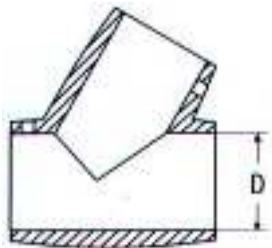

D
 22mm
 25mm

Σύνδεσμοι T διαιρούμενοι 60° M8506 INOX A4

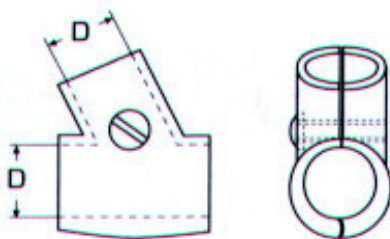

D
 22mm
 25mm

Σύνδεσμοι T χυτοί 90° M8205 INOX A4

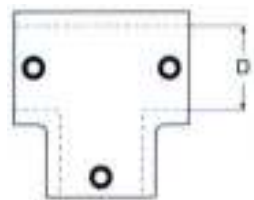

D
 22mm
 25mm

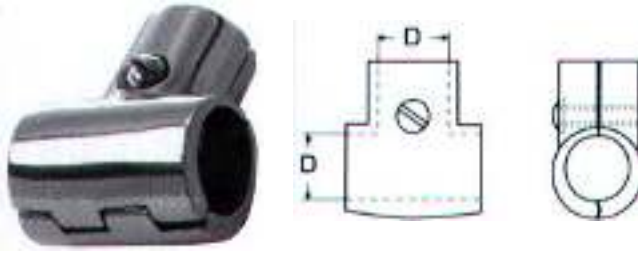
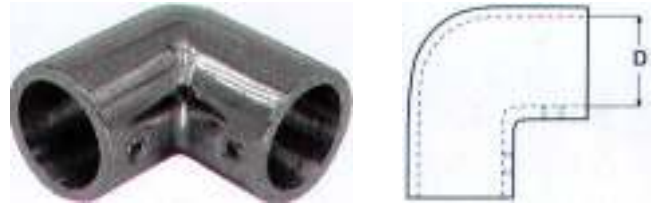
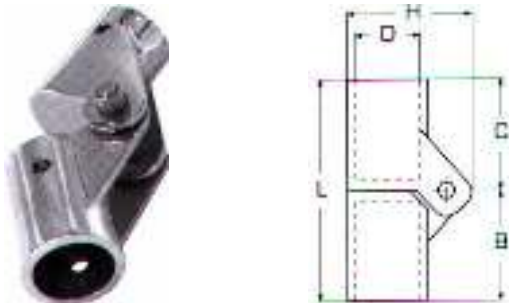
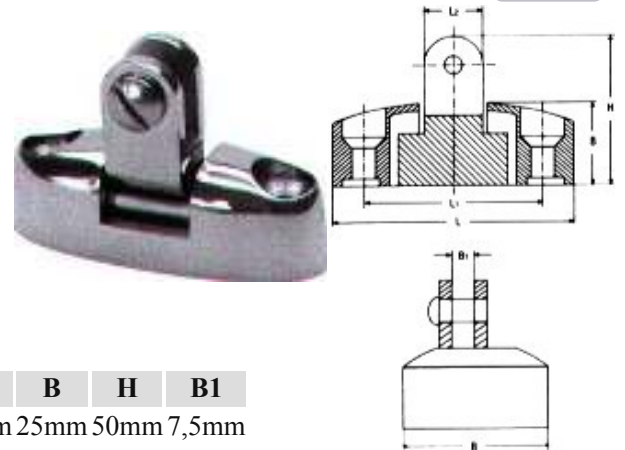
**Σύνδεσμοι T διαιρούμενοι 90° M8505 INOX A4****D**22mm
25mm**Γωνίες χυτές 90° M8210 INOX A4****D**22mm
25mm**Τρίστομα χυτά M8211 INOX A4****D**22mm
25mm**Σταυροί χυτοί M8387 INOX A4****D**22mm
25mm**Μεντεσέδες σωλήνων M8572 INOX A4****D L B/C H**22mm 80mm 40mm 47mm
25mm 80mm 40mm 49mm**Βάσεις σπαστές για ποτήρι M8573 INOX A4****L B H B1**

70mm 25mm 50mm 7,5mm

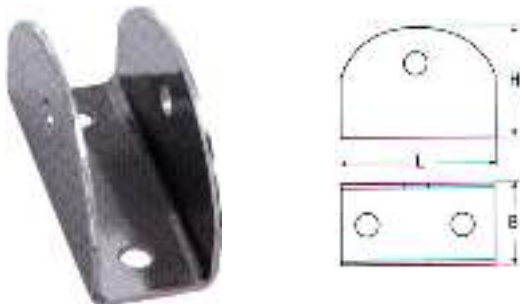
Βάσεις σωλήνα σκάλας M8134 INOX A4**D B L**

48mm 28mm 34mm

Ταυ σωλήνος με κούρπα M8148 INOX A4**D Γωνία L**22mm 90° 52mm
25mm 90° 52mm
25mm 60° 52mm



Ταυ σωλήνων πλακέ M8138 INOX A4

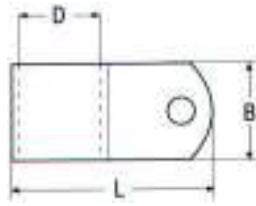

D	B	L
20mm	45mm	30mm

Σφυγκτήρες σωλήνων M8135 INOX A4

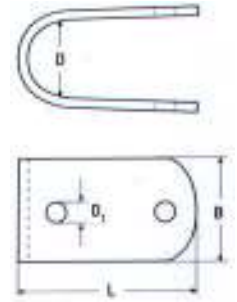

L	B	D	D1
58mm	30mm	20mm	7mm

Σφυγκτήρες σωλήνων M8354 INOX A4

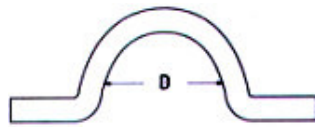

Τύπος	D
Ω	25mm
U	25mm

Σφυγκτήρες σωλήνων ελαφρού τύπου M8460 INOX A4

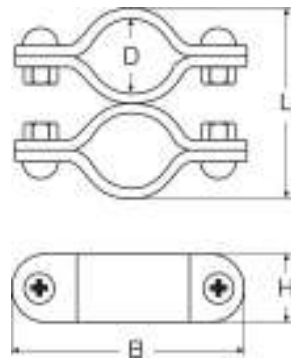

Τύπος	D	B	L	H
Περιστρεφόμενοι	25mm	62mm	55mm	20mm
Σταθεροί	25mm	60mm	55mm	20mm
Μονοί	25mm	62mm	25mm	20mm

Σφυγκτήρες σωλήνων βαρέως τύπου M8461 INOX A4

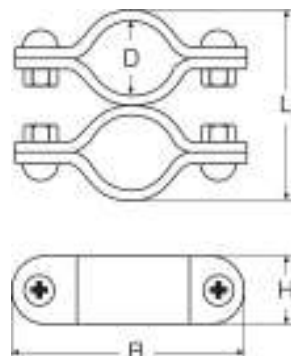

Τύπος	D	L	H
Περιστρεφόμενοι	19-30mm	65mm	55mm
Σταθεροί	19-30mm	65mm	55mm
Με απόσταση	19-30mm	65mm	72mm

Διαπερείς σωλήνες M8271 INOX A4

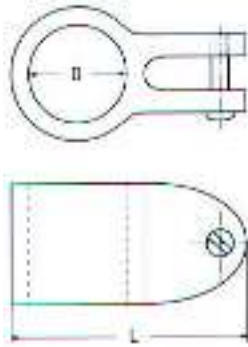
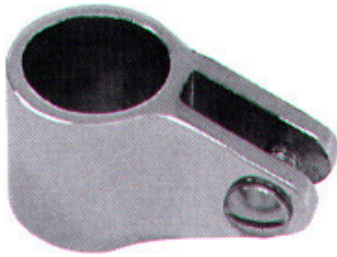

D L
22mm 51mm
25mm 59mm

Διαπερείς σωλήνες διαιρούμενοι M8277 INOX A4

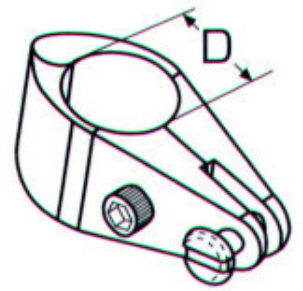
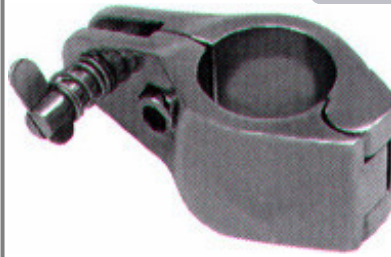

D L
22mm 69mm
25mm 69mm

Βάσεις με πύρο και ελατήριο M8328 INOX A4

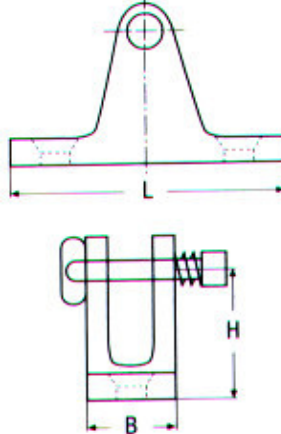

L B H
60mm 18mm 29mm

Βάσεις με βίδα M8273 INOX A4

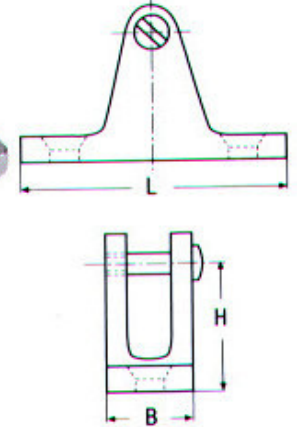
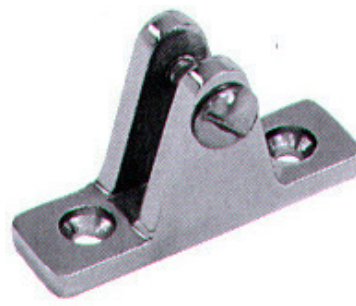

L B H
60mm 18mm 29mm

Βάσεις κούρμα με πύρο και ελατήριο M8329 INOX A4

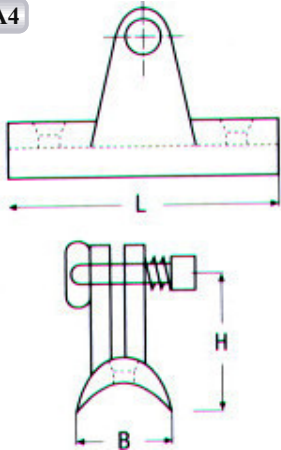

L B H
60mm 22mm 29mm

Βάσεις κούρμα με βίδα M8272 INOX A4

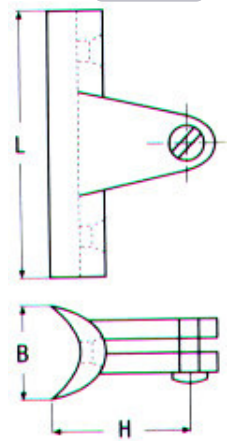
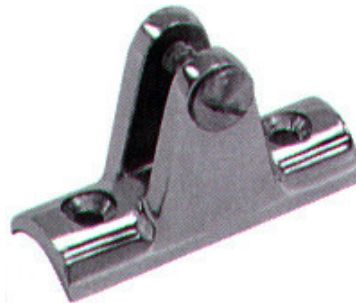

L B H
60mm 22mm 29mm

Βάσεις κάθετες με βίδα M8274 INOX A4

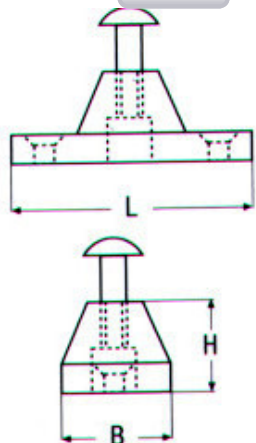

L B H
50mm 23mm 19mm

Αγκράφες M8764 INOX A4

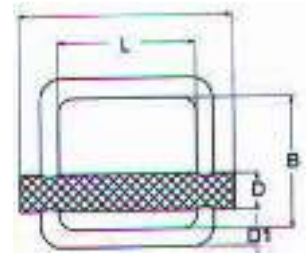

L B D D1
25mm 25mm 9mm 4mm



Γωνίες 90° MM INOX 304

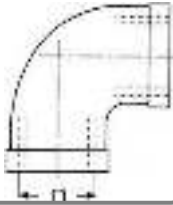

D	D
1/8"	1"
1/4"	1 1/4"
3/8"	1 1/2"
1/2"	2"
3/4"	

Γωνίες 90° ΜΕ INOX 304



D	D
1/8"	1"
1/4"	1 1/4"
3/8"	1 1/2"
1/2"	2"
3/4"	

Μούφες INOX 304

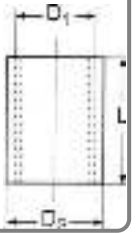

D	D
1/8"	1"
1/4"	1 1/4"
3/8"	1 1/2"
1/2"	2"
3/4"	

Τάπες θηλυκές INOX 304



D	D
1/8"	1"
1/4"	1 1/4"
3/8"	1 1/2"
1/2"	2"
3/4"	

Ρακόρ INOX 304



D	D
1/8"	1"
1/4"	1 1/4"
3/8"	1 1/2"
1/2"	2"
3/4"	

Τάπες αρσενικές INOX 304



D	D
1/8"	1"
1/4"	1 1/4"
3/8"	1 1/2"
1/2"	2"
3/4"	

Συστολές Αμερικής INOX 304



Τύπος	Τύπος
1/8"X1/4"	3/4"X1"
1/4"X3/8"	1"X1 1/2"
1/4"X1/2"	1"X1 1/4"
3/8"X1/2"	1"X2"
1/2"X3/4"	1 1/4"X1 1/2"
1/2"X1"	1 1/2"X2"

Σωληνομαστοί INOX 304



Τύπος	Τύπος
1/8"-5cm	3/4"-15cm
1/8"-10cm	3/4"-20cm
1/4"-5cm	1"-10cm
1/4"-10cm	1"-15cm
3/8"-5cm	1"-20cm
3/8"-10cm	1 1/4"-10cm
1/2"-10cm	1 1/4"-20cm
1/2"-15cm	1 1/2"-10cm
1/2"-20cm	1 1/2"-20cm
3/4"-10cm	2"-10cm
	2"-20cm

Βάνες INOX 316



Τύπος	Τύπος
1/4"	1"
3/8"	1 1/4"
1/2"	1 1/2"
3/4"	2"

Νίπελ INOX 304

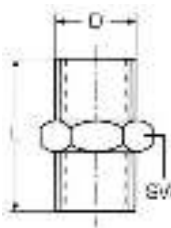

D	D
1/8"	1"
1/4"	1 1/4"
3/8"	1 1/2"
1/2"	2"
3/4"	

Ακροσωλήνια INOX 304

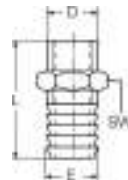

D	D
1/8"	1"
1/4"	1 1/4"
3/8"	1 1/2"
1/2"	2"
3/4"	

Ταν θηλυκά INOX 304



D	D
1/8"	1"
1/4"	1 1/4"
3/8"	1 1/2"
1/2"	2"
3/4"	

Παξιμάδια INOX 304

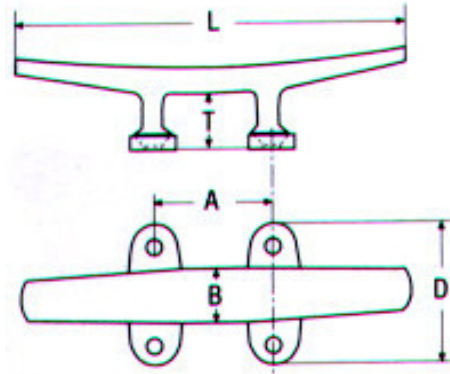
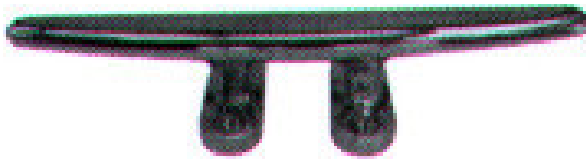

D	D
1/8"	1"
1/4"	1 1/4"
3/8"	1 1/2"
1/2"	2"
3/4"	

Κοτσανέλα πλακέ με 4 τρύπες M8218 INOX A4

L	B	A	T	D
100mm	14mm	30mm	14mm	36mm
125mm	15mm	40mm	28mm	45mm
150mm	20mm	45mm	20mm	53mm
200mm	23mm	55mm	24mm	69mm
250mm	25mm	58mm	30mm	65mm

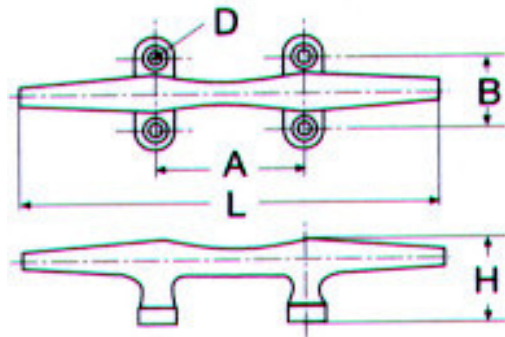
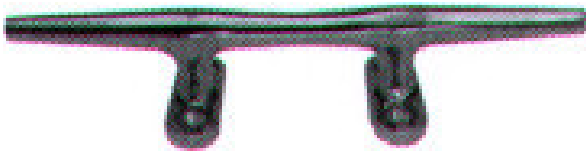
Κοτσανέλα στρόγγυλα με 4 τρύπες M8217 INOX A4

L	B	H	D	A
125mm	25mm	28mm	5mm	54mm
150mm	26mm	32mm	6mm	56mm
200mm	34mm	39mm	6,5mm	72mm
250mm	44mm	48mm	8,5mm	94mm
300mm	49mm	53mm	8,5mm	99mm

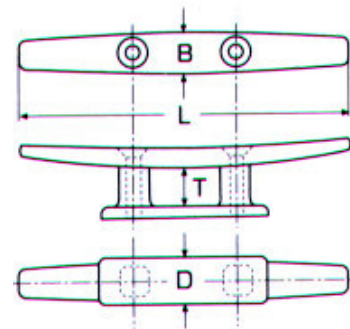
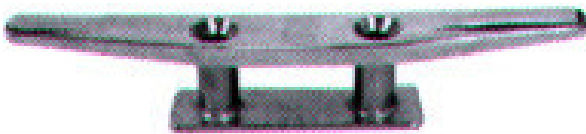
Κοτσανέλα πλακέ με 2 τρύπες M8298 INOX A4

L	B	D	T
100mm	14mm	15mm	16mm
125mm	16mm	18mm	14mm
150mm	19mm	21mm	19mm
200mm	22mm	24mm	22mm
250mm	25mm	27mm	25mm

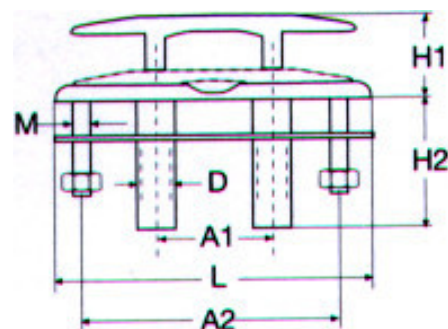
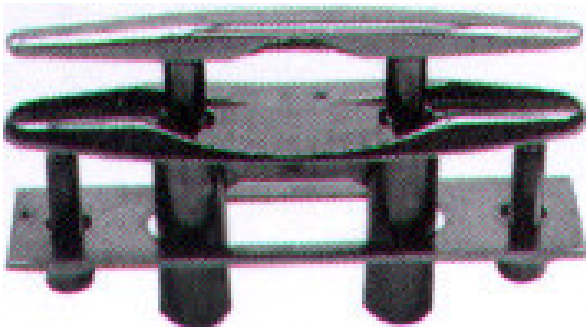
Κοτσανέλα χωνευτά M8232 INOX A4

L	H1	H2	D	M	A1	A2
160mm	36mm	61mm	20mm	3/8"	58mm	129mm



Κοτσανέλα χυτά χωρίς τρύπες M8100 INOX A4

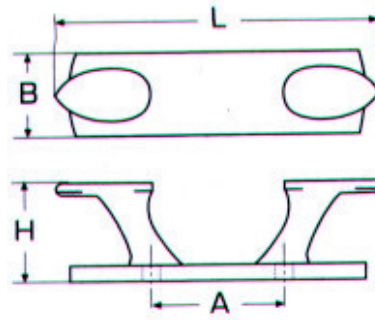
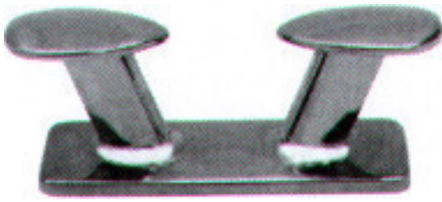

L	B	H	D	A
256mm	80mm	100mm	M16	130mm

Δέστρες με τετράγωνη βάση M8520 INOX A4

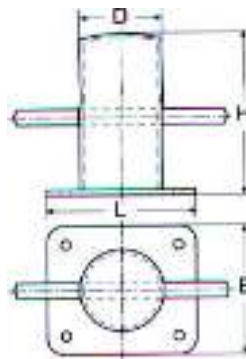

L	B	H	D
100mm	90mm	100mm	50mm
120mm	120mm	100mm	60mm

Γλύστρες χυτές μύτη (σετ) M8219 INOX A4

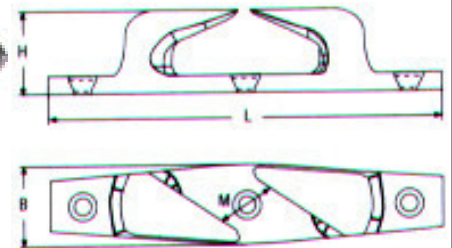

Τύπος	L	B	M	H
αριστερή	114mm	23mm	15mm	25mm
δεξιά	114mm	23mm	15mm	25mm
αριστερή	152mm	35mm	26mm	30mm
δεξιά	152mm	35mm	26mm	30mm

Γλύστρες χυτές μύτη M8220 INOX A4



L	B	H
127mm	20mm	24mm
152mm	24mm	36mm

Δέστρες μίνι M8367 INOX A4

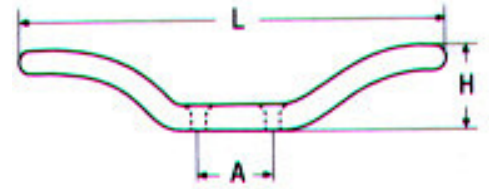

L	H	A
68mm	12mm	10mm
114mm	20mm	21mm

Στριφτάρια άγκυρας M8304 INOX

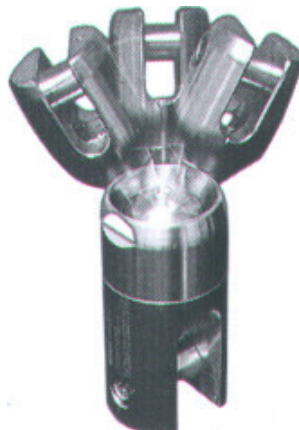

Ø Αλυσίδας	D	B	SWL	BL
6	38mm	16mm	6,00kN	24,00kN
8	45mm	21mm	10,00kN	40,00kN

Άγκυρες M8302 INOX

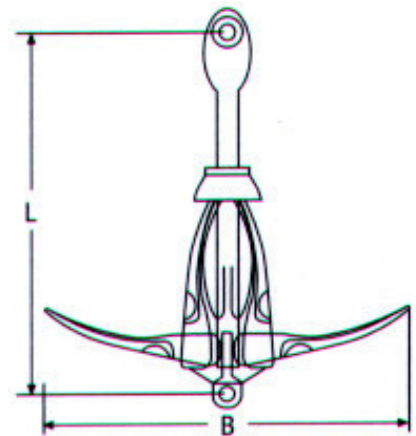

Κιλά	L	B
2,5	340mm	330mm
4	410mm	400mm
7	465mm	470mm

Αλυσίδες με κοντό χαλκά DIN766 INOX A4



Πάχος

2mm	
3mm	
4mm	
5mm	
6mm	
8mm	24,60
10mm	



αξιολογιάννης akraper.gr 2310792378